

\* La dulapuri mobile si bancuri de lucru transportul se oferteaza separat

EN | VALID FROM 01.03.2024 - 31.12.2024

GEDORE  red

# IMPULSE

24

TOOL PROMOTION



Master  
Tool case XL

€449,00  
+ VAT

€50,41  
+ VAT

Torsion Bit  
Set



Headlamp 260

€25,20  
+ VAT

# 104 TOOLS, 12 HIGHLIGHTS AND INNOVATIONS

**10** R3300 3043  
TORSION  
BIT SET



**54** R9550 0058  
HEADLAMP 260



R2165 2101  
MASTER  
TOOL  
CASE XL

**24**



**GEDORE red**











**R9520 O111**  
**MINI WORK**  
**LAMP UV**

**52**



## CONTENTS

	<b>RATCHET SPANNERS</b>	<b>04 – 07</b>
	<b>SOCKET SETS</b>	<b>08 – 25, 30</b>
	<b>BIKE-SETS</b>	<b>22</b>
	<b>RANGE OF SOCKETS</b>	<b>30 – 31</b>
	<b>TORQUE WRENCHES</b>	<b>32</b>
	<b>SCREWDRIVERS AND BITS</b>	<b>33 – 36</b>
	<b>WORKSHOP EQUIPMENT</b>	<b>37 – 45</b>
	<b>STRIKING TOOLS</b>	<b>46</b>
	<b>PLIERS</b>	<b>47 – 48</b>
	<b>1000V</b>	<b>48</b>
	<b>WORK LAMPS</b>	<b>49 – 55</b>
	<b>CUTTING / FILING / DRILLING</b>	<b>56, 58 – 59</b>
	<b>MEASURING / MARKING</b>	<b>57</b>

**R0910 XXXX**  
COMBINATION  
SPANNER SET  
metric

from

**€47,47**  
+ VAT



- > Acc. to DIN 3113, Form A, ISO 3318, ISO 7738
- > Jaw set at 15°
- > In holder



Code	No.	Contents	Pieces	Weight kg	excl. VAT
3300994	R09105017	Combination spanner 6 7 8 9 10 11 12 13 14 15 16 17 18 19 20 21 22 mm	17	1,8	47,47
3300995	R09105024	Combination spanner 6 7 8 9 10 11 12 13 14 15 16 17 18 19 20 21 22 23 24 26 27 28 30 32 mm	24	5,4	94,12

**R0510 5008**  
DOUBLE  
OPEN ENDED  
SPANNER SET  
long, metric,  
8 pieces

**€26,55**  
+ VAT



- > Acc. to DIN 3110, ISO 3318, ISO 1085, ISO 10102
- > Jaw set at 15°
- > In holder



Code	No.	Contents	Pieces	Weight kg
3300959	R05105008	Double Open Ended spanner 6x7 8x9 10x11 12x13 14x15 16x17 18x19 20x22 mm	8	0,7

**R0512 5012**  
DOUBLE  
OPEN ENDED  
SPANNER SET  
short, metric,  
12 pieces

**€33,27**  
+ VAT



- > Acc. to DIN 895, ISO 3318, ISO 1085
- > Jaw set at 15°
- > In holder



Code	No.	Contents	Pieces	Weight kg
3300961	R05125012	Double Open ended spanners 6x7 8x9 10x11 12x13 14x15 16x17 18x19 20x22 21x23 24x26 25x28 27x32 mm	12	2

**R0740 5006**  
**DOUBLE ENDED RING**  
**RATCHET SPANNER SET**  
 straight, metric, 6 pieces

**€94,12**  
 + VAT



- > In accordance with DIN 837
- > Straight pattern
- > 72 teeth Ratchet mechanism
- > In holder



Code	No.	Contents
3300898	R07405006	Double ring ratchet spanner 8x9 10x11 12x13 14x15 16x18 17x19 mm

Pieces	Weight kg
6	0,865

**R0750 1019**  
**DOUBLE ENDED RING RATCHET**  
**SPANNER**  
 4in1

**€31,34**  
 + VAT



- > For 10, 13, 17, 19 mm
- > Straight pattern
- > With lever change



Code	No.	Width across flats mm	Length mm
3300899	R07501019	10 x 13 x 17 x 19	210

Weight kg
0,21

**R0750 1002**  
**DOUBLE ENDED RING RATCHET**  
**SPANNER SET**  
 2 pieces

**€44,61**  
 + VAT



- > 2 wrenches for 63 screw/bolt heads
- > With lever change
- > 72 teeth Ratchet mechanism



Code	No.	Contents
3300900	R07501002	Hexagon, bi-hex 5/16 3/8 7/16 1/2 9/16 5/8 11/16 3/4" SPLINE, hexagon, bi-hex A/F 8 10 11 13 14 16 17 19 mm TX E10 E12 E14 E16 E18 E20 E22 E24 Square 9/32 11/32 3/8 7/16 15/32 17/32 9/16 5/8" Square A/F 7 9 11 12 13 14 16 mm

Pieces	Weight kg
2	0,398

# THE NEW COMBINATION RATCHET WRENCH SET IN WS 10, 13, 17 AND 19

**NEW**

The wrenches for confined space screw connections.

The GEDOREd **combination ratchet wrench R072011XX** is the ideal solution for ratchet loosening or quick tightening. Thanks to the angled ring end, hard to reach screw connections can be easily loosened and tightened, and the risk of injury in confined installation spaces is reduced. The innovative clamping function in the ratchet head ensures especially efficient working – screws or nuts can be safely guided to the point of use.

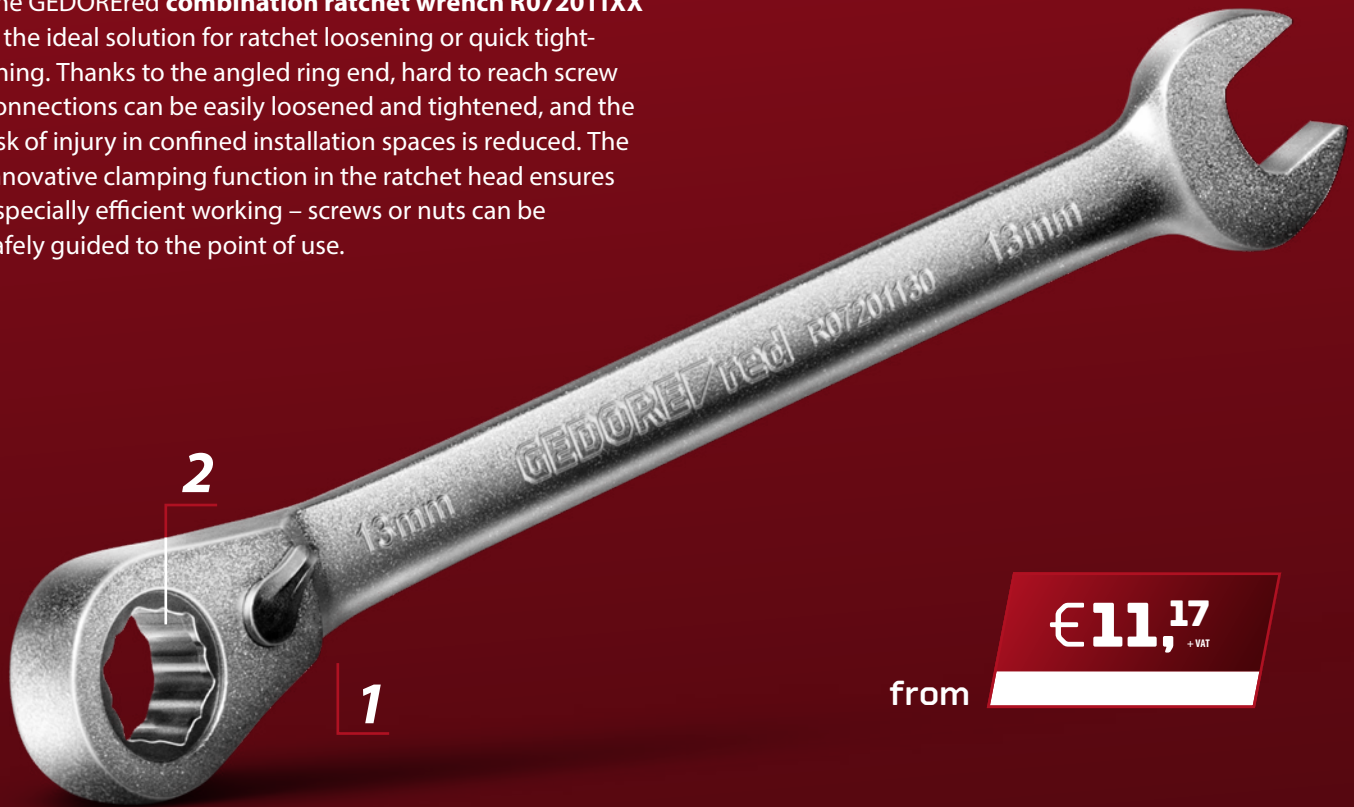

from **€11,17** + VAT

Combination ratchet spanner 13 mm – R072011XX

**1** ANGLED RING RATCHET HEAD

**2** EFFICIENT WORKING WITH HOLDING FUNCTION



**PROBLEM-FREE**

**R0720 11XX**  
**COMBINATION RATCHET**  
**SPANNER**

Reversible



- > Innovative hold function in the ratchet head for holding and safely guiding nuts or screws and bolts without slipping through
- > Problem-free with long threaded rods, if long nuts are not available or sufficient
- > 15° angled ring ratchet head for fault-free working



Code	No.	Width across flats mm	Length mm	Weight kg	excl. VAT
3301004	R07201100	10	161	0,063	11,17
3301005	R07201130	13	183	0,103	12,18
3301006	R07201170	17	225	0,19	14,87
3301007	R07201190	19	245	0,243	15,87

**R0720 50XX**  
**COMBINATION RATCHET**  
**SPANNER SET**

reversible



- > In accordance with DIN 3113, ISO 3318
- > Ring offset to 15°, reversible for right and left hand operation
- > 72 teeth Ratchet mechanism
- > In holder

from **€61,76** + VAT



Code	No.	Contents	Pieces	Weight kg	excl. VAT
3300872	R07205005	Combination ratchet spanner 8 10 13 17 19 mm	5	0,688	61,76
3300873	R07205012	Combination ratchet spanner 8 9 10 11 12 13 14 15 16 17 18 19 mm	12	1,576	131,93

**R0710 5005**  
**COMBINATION RATCHET**  
**SPANNER SET**

metric, 5 parts



- > In accordance with DIN 3113, ISO 3318
- > Straight pattern
- > 72 teeth Ratchet mechanism
- > In holder



Code	No.	Contents	Pieces	Weight kg
3300849	R07105005	Combination ratchet spanner 8 10 13 17 19 mm	5	0,699

**R3300 3032**  
**1/4" BIT SET**  
 32 pieces

**€26,<sup>21</sup>**  
 + VAT



- > Set with common bit sizes and drive adapter with bit lock
- > Screwdriver with strong magnet for quick and easy bit replacement and ergonomic grip
- > Quick-change adapter enables quick bit changes
- > Suitable for hand and machine operated work



Code	No.	Contents	Width mm	Height mm	Depth mm	Pieces	Weight kg
3301348	R33003032	1/4" Magnetic Bit Screwdriver 1/4" Quick change adapter 1/4" Bits, 25mm: PH1 (3x), PH2 (3x), PH3 (3x) PZ1 (3x), PZ2 (3x), PZ3 (3x) Slot 4.5 5.5 6.5 TX T10 T15 T20 T25 T30 T40 Hexagon socket 4 5 6 mm	190	52	110	32	0,48

**R3300 3040**  
**1/4" BIT SET**  
 40 pieces

**€40,<sup>66</sup>**  
 + VAT



- > Set with common bit sizes and drive adapter with bit lock
- > Screwdriver with strong magnet for quick and easy bit replacement and ergonomic grip
- > Reversible ratchet with 2C-handle and 5° return angle and reversible lever for convenient change of direction
- > Quick-change adapter enables quick bit changes



Code	No.	Contents	Width mm	Height mm	Depth mm	Pieces	Weight kg
3301349	R33003040	1/4" Sockets 5.5 6 7 8 10 12 13 mm 1/4" Reversible ratchet 1/4" Adapter 4kt x 6kt 1/4" Magnetic bit screwdriver 1/4" Quick change adapter 1/4" Bits, 25mm: PH1 (2x), PH2 (3x), PH3 (1x) PZ1 (1x), PZ2 (3x), PZ3 (1x) Slotted 5.5mm Hexagon socket 3 4 5 6 8 mm TX T10 T15 T20 T25 T30 T40 TX T10H T15H T20H T25H T30H Bit adapter 1/4" square x 1/4" hex	230	52	130	40	0,8



**R3300 3051**  
**1/4" BIT SET**  
 51 pieces

**€42,<sup>51</sup>**  
 + VAT



- › Set with common bit sizes and drive adapter with bit lock
- › Long bits
- › Reversible ratchet with 2C-handle and 5° return angle and reversible lever for convenient change of direction
- › Sockets with non-slip longitudinal knurling



Code	No.	Contents	Width mm	Height mm	Depth mm	Pieces	Weight kg
3301350	R33003051	1/4" Sockets 4 5 5.5 6 7 8 9 10 11 12 13 14 mm 1/4" Reversible ratchet, 1/4" Extension 100mm, 1/4" Adapter square x hexagon 1/4" Bits 25mm: PH1 (1x), PH2 (2x), PH3 (1x), PZ1 (1x), PZ2 (2x), PZ3 (1x) Slotted 4 4.5 6.5mm, TX T10 T15 T20 T25 T27 T30 T40 Hexagon socket 2 3 4 5 6 mm, Bit adapter 1/4" square x 1/4" hex 1/4" Bits 90mm: PH1 (1x), PH2 (1x), PH1 (1x), PH2 (1x), TX T20 T25 T30 Hexagon socket 3 4 5 6 mm Slotted 5.5mm	230	52	130	51	0,98

**R3300 3067**  
**1/4" BIT SET**  
 67 pieces

**€42,<sup>51</sup>**  
 + VAT

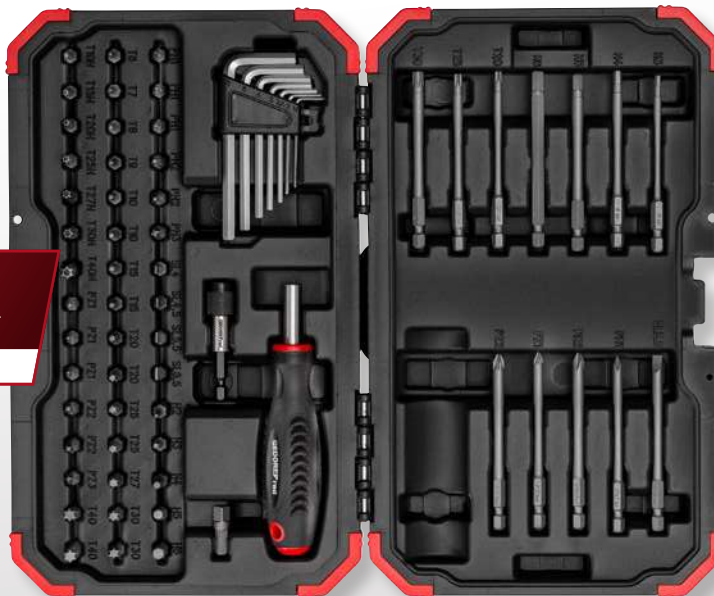

- › Set with common bit sizes and drive adapter with bit lock
- › Long bits
- › Screwdriver with strong magnet for quick and easy bit replacement and ergonomic grip
- › Quick-change adapter enables quick bit changes



Code	No.	Contents	Width mm	Height mm	Depth mm	Pieces	Weight kg
3301352	R33003067	Offset screwdriver set 1.5, 2.5, 3, 4, 5, 6 mm 1/4" Magnetic bit screwdriver 1/4" Quick change adapter 1/4" Bits, 25mm: PH1 (3x), PH2 (2x), PH3 (1x), PZ1 (3x), PZ2 (2x), PZ3 (1x) Slotted 4, 4.5, 5.5, 6, 6.5mm TX T6, T7, T8, T9, T10, T10, T15, T15, T20, T20, T25, T25, T27, T30, T30, T40, T40 TX T10H, T15H, T20H, T25H, T27H, T30H, T40H Hexagon socket 2, 3, 4, 5, 6 mm Bit adapter 1/4" square x 1/4" hex 1/4" bits, 90mm: PH1 (1x), PH2 (1x), PZ1 (1x), PZ2 (1x), TX T20, T25, T30 Hexagon socket 3, 4, 5, 6 mm, Slotted 5.5mm	300	52	180	67	1,1

# 43-PIECE TORSION BIT SET INCLUDING BIT SCREWDRIVER

**NEW**

Long or short – the right bit is always at hand in the compact plastic case.

The GEDORE red **torsion bit set R33003043** is simply ideal for especially demanding screwing joints. Tough timber or even metal, the torsion zone ensures extremely high stressability and protects the bits against premature wear and tear. The included bit screwdriver is flexible and has a ratchet function, so it is also comfortable for working on hard to reach areas. The easy to see size marking on the bits means there's no tiresome looking around and ensures quick access.



Torsion bit set – R33003043

**1** FLEXIBLE BIT SCREWDRIVER INCLUDING RATCHET

**2** HIGHLY STRESSABLE TORSION BITS

**3** 43 PIECES FOR NUMEROUS SCREW JOINTS

**4** SAVES TIME: SIZE MARKING ON THE BITS



**FOR TOUGH SCREWING JOINTS**

**R3300 3043**  
**TORSION BIT SET**  
 43 pieces

- > 43-piece torsion bit set for a multitude of screw joints
- > Flexible bit screwdriver with ratchet function (for working in confined spaces)
- > Bits with torsion zone for high stresses
- > Easy to see size marking on bits for quick access
- > For manual and machine operation



**€50,41**  
 + VAT

Code	No.	Contents	Width mm	Height mm	Depth mm	Pieces	Weight kg
3304902	R33003043	Ratchet screwdriver magnetic 1/4" Quick change adapter Bit adapter 1/4" hex x 1/4" square, L. 50mm Bit adapter 1/4" hex x 3/8" square, L. 50mm Socket, magnetic, with 1/4" hex drive 8 10 13   65mm 1/4" Torsion bits, 25mm: PH1 (1x), PH2 (2x), 3 (1x) PZ1 (1x), PH2 (2x), 3 (1x) TX T10, T15, T20, T25, T30, T40 Slotted 5.5, 6.5 mm 1/4" Torsion bits, 50mm: PH1 (1x), PH2 (2x), PH3 (1x) Hexagon socket 3, 4, 5 mm PZ1 (1x), PZ2 (2x), PZ3 (1x) TX T10, T15, T20, T25, T30 1/4" Torsion bits, 90mm: PH2 (1x) PZ2 (1x) Slotted 5.5 mm TX T25	250	52	140	43	1

**R3300 5014**  
**1/4" BIT BOX**  
 14 pieces

**€9,49**  
 + VAT



- > Suitable for hand and machine operated work
- > Bit box with the common bit sizes and drive adaptor with bit locking
- > Hexagon drive acc. to DIN 3126 ISO 1173 - C 6.3



Code	No.	Contents	Width mm	Height mm	Depth mm	Pieces	Weight kg
3301347	R33005014	1/4" Hexagon 3 4 5 mm 1/4" Slotted 4 5 6 mm 1/4" PH 1 2 3 1/4" TX T10 T15 T20 T25 Bit holder 1/4" hex x 1/4" hex, with magnet	105	30	60	14	0,11

**R3300 5007**  
**1/4" BIT BOX**  
 7 pieces

**€6,71**  
 + VAT



- > Suitable for hand and machine operated work
- > Bit box with the common bit sizes and drive adaptor with bit locking
- > Hexagon drive acc. to DIN 3126 ISO 1173 - C 6.3



Code	No.	Contents	Width mm	Height mm	Depth mm	Pieces	Weight kg
3301345	R33005007	1/4" Slotted 4 5 6 mm 1/4" PH 1 2 3 Bit holder 1/4" hex x 1/4" hex, with magnet	105	30	60	7	0,08

**R3300 5009**  
**1/4" BIT BOX**  
 9 pieces

**€7,64**  
 + VAT



- > Suitable for hand and machine operated work
- > Bit box with the common bit sizes and drive adaptor with bit locking
- > Hexagon drive acc. to DIN 3126 ISO 1173 - C 6.3



Code	No.	Contents	Width mm	Height mm	Depth mm	Pieces	Weight kg
3301346	R33005009	1/4" Hexagon socket 3 4 5 mm 1/4" Slotted 4 5 6 mm 1/4" PH 1 2 Bit holder 1/4" hex x 1/4" hex, with magnet	105	30	60	9	0,086

**R3300 5031**  
**1/4" BIT BOX**  
 32 pieces

**€14,<sup>28</sup>**  
 + VAT



- > Bit box with the wide range of bit sizes and drive adaptor with bit locking
- > Suitable for hand and machine operated work
- > Hexagon drive acc. to DIN 3126 ISO 1173 - C 6.3



Code	No.	Contents	Width mm	Height mm	Depth mm	Pieces	Weight kg
3301338	R33005031	1/4" Hexagon socket 3 4 5 1/4" Slotted 0.6x4.5 1.0x5.5 1.2x6.5 2x 1/4" PH 1 2 3 2x 1/4" PZ 1 2 3 2x TX T10 T15 T20 T25 T30 T40 Quick change adaptor for 1/4" bits C 6.3 with magnet Bit adaptor 1/4" hex x 1/4" square	110	40	70	32	0,25

**R3500 3040**  
**BIT SET TX / XZN / SK**  
 40 pieces

**€37,<sup>97</sup>**  
 + VAT

- > For hand-operated applications
- > Extensive bit set with long and short bit versions
- > Reinforced bits, 10 mm
- > Hexagon drive acc. to DIN 3126 ISO 1173 - C 10



Code	No.	Contents	Width mm	Height mm	Depth mm	Pieces	Weight kg
3301572	R35003040	Hexagon socket bit 4 5 6 8 10 12   30 mm Hexagon socket bit 4 5 6 8 10 12   75 mm TX Bit T20 T25 T30 T40 T45 T50 T55   30 mm TX Bit T20 T25 T30 T40 T45 T50 T55   75 mm XZN Bit M5 M6 M8 M10 M12   30 mm XZN Bit M5 M6 M8 M10 M12   75 mm Bit adapter square socket 1/2" to hexagon socket 10mm Bitadapter square socket 3/8" to hexagon socket 10mm	335	50	195	40	1,75

**R5900 3026**  
**3/8" SOCKET SET**  
 26 pieces

> For all jobs with maintenance work, for tradespeople or in the workshop

**€60,75**  
 + VAT



Code	No.	Contents	Width mm	Height mm	Depth mm	Pieces	Weight kg
3300053	R59003026	3/8" 2C-Lever reversible ratchet fine-toothed, 72 teeth   180 mm 3/8" Socketbi-hex 6 7 8 9 10 11 12 13 14 15 16 17 18 19 20 21 22 24 mm 3/8" Spark plug socket 16 21 mm   65 mm 3/8" Socket extension 75 150 mm 3/8" Sliding T Bar 200 mm 3/8" Universal joint 48 mm Reducer 3/8" - 1/4"   27 mm	302	54	185	26	2,44

**R6900 3069**  
**1/2" SERVICE SOCKET SET**  
 69 pieces

> Ideal combination for jobs with service work

**€178,99**  
 + VAT

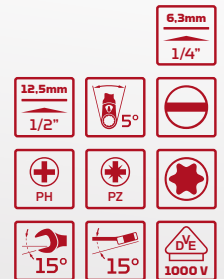
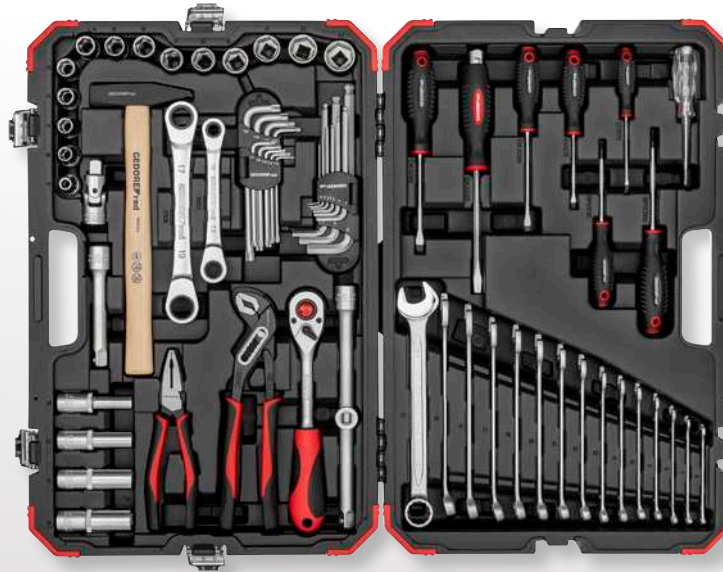

Code	No.	Contents	Width mm	Height mm	Depth mm	Pieces	Weight kg
3300191	R69003069	1/2" 2C-Lever reversible ratchet, fine-toothed, 72 teeth   250 mm 1/2" Socket 10 11 12 13 14 15 16 17 18 19 21 22 24   38 mm 1/2" Socket 10 13 17 19   77mm 1/2" Socket extension 125 250 mm 1/2" Universal joint   66 mm Adaptor 3/8 x 1/2 square   44mm Double ring ratchet spanner 10x13 17x19 Combination spanner 6 7 8 9 10 11 12 13 14 15 16 17 18 19 21 Offset screwdriver set, hexagon socket SW 1.5 2 2.5 3 4 5 6 8 10 Offset screwdriver set TX T10 T15 T20 T25 T27 T30 T40 T45 T50 Screwdriver slotted 3 4 5 5.5 Screwdriver slotted with impact cap 6.5 Screwdriver Phillips PH 1 2 Phase tester slot 120-250 V Combination pliers 180 mm Water pump pliers 10" Engineer's hammer 300 g	552	100	360	69	9,9

**R6900 3061**  
**1/2" SOCKET SET**  
 61 pieces

> Ideal for all jobs for  
 do-it-yourselfers



Code	No.	Contents	Width mm	Height mm	Depth mm	Pieces	Weight kg
<b>3300370</b>	R69003061	R6100xxxx Socket 1/2" hexagon 8 9 10 11 12 13 14 15 16 17 19 21 22 24 mm R60000027 2C-Reversible ratchet 1/2" L. 250 mm Return angle 5° R65300012 Universal joint 1/2" L. 66 mm R6102xxxx Spark plug socket 1/2" 16 18 21 mm R651000xx Socket extension 1/2" L. 125 250 mm R57300008 Extension piece 3/8" x 1/2 square L.44 mm R28100010 Water pump pliers 10" 7-way R28302180 Combination pliers L. 180 mm 2C-handle R36605008 Offset screwdriver set 1.5-8 mm 8 pcs. R36405008 Offset screwdriver set TX T9-40 8 pcs. R92100020 Engineer's hammer 500 g L. 320 mm ash R0910xxxx Combination spanner 6 7 8 9 10 11 12 13 14 15 16 17 18 19 mm R38100315 2C-Screwdriver slotted 3 mm 0.5x75 mm, 5.5 mm 1x100 mm, 8 mm 1.2x100 mm R38200115 2C-Screwdriver PH1 L. 80 mm, PH2 L. 100 mm R38120001 MOTOR VEHICLE Voltage tester 3-48 V	452	86	340	61	7,14

**R6100 3114**  
**1/2" SOCKET SET**  
 Deep Sockets, 14 pieces

> For hand-operated applications  
 > Long version

**€85,71**  
 + VAT



Code	No.	Contents	Width mm	Height mm	Depth mm	Pieces	Weight kg
<b>3300008</b>	R61003114	10 12 13 14 15 17 19 21 22 23 24 27 30 32   77 mm	272	80	383	14	3,746

**R6800 3016**  
**1/2" SOCKET**  
**SET TX**  
 16 pieces

**€56,<sup>97</sup>**  
 + VAT



- > For hand-operated applications
- > Short version



Code	No.	Contents	Width mm	Height mm	Depth mm	Pieces	Weight kg
3300009	R68003016	Socket TX E10 E11 E12 E14 E16 E18 E20 E22 E24 Screwdriver bit socket TX T30 T40 T45 T50 T55 T60 T70	300	52	180	16	1,69

**R6800 3020**  
**3/8"+1/2"**  
**SOCKET SET**  
 20 pieces

**€56,<sup>97</sup>**  
 + VAT



- > For hand-operated applications



Code	No.	Contents	Width mm	Height mm	Depth mm	Pieces	Weight kg
3300045	R68003020	3/8" Socket TX E6 E7 E8 E10 3/8" Screwdriver bit socket TX T10 T15 T20 T25 T27 1/2" Socket TX E12 E14 E16 E18 E20 1/2" Screwdriver bit socket TX T30 T40 T45 T50 T55 Reducer 1/2" square x 3/8" square	180	52	300	20	2

**R6300 3012**  
**1/2" IMPACT**  
**SOCKET SET**  
 12 pieces

**€52,<sup>26</sup>**  
 + VAT



- > Machine-operated, fixing with safety ring / pin
- > Square drive as per DIN 3121 - G 12,5, ISO 1174
- > Acc. to DIN 3129, ISO 2725-2



Code	No.	Contents	Width mm	Height mm	Depth mm	Pieces	Weight kg
3300574	R63003012	10 11 12 13 14 15 16 17 19 21 22 24 mm	180	52	185	12	1,598



**R4600 3092**  
**1/4" + 1/2" SOCKET SET**  
 92 pieces

> Ideal for all jobs with maintenance work,  
 for trades people or in the workshop

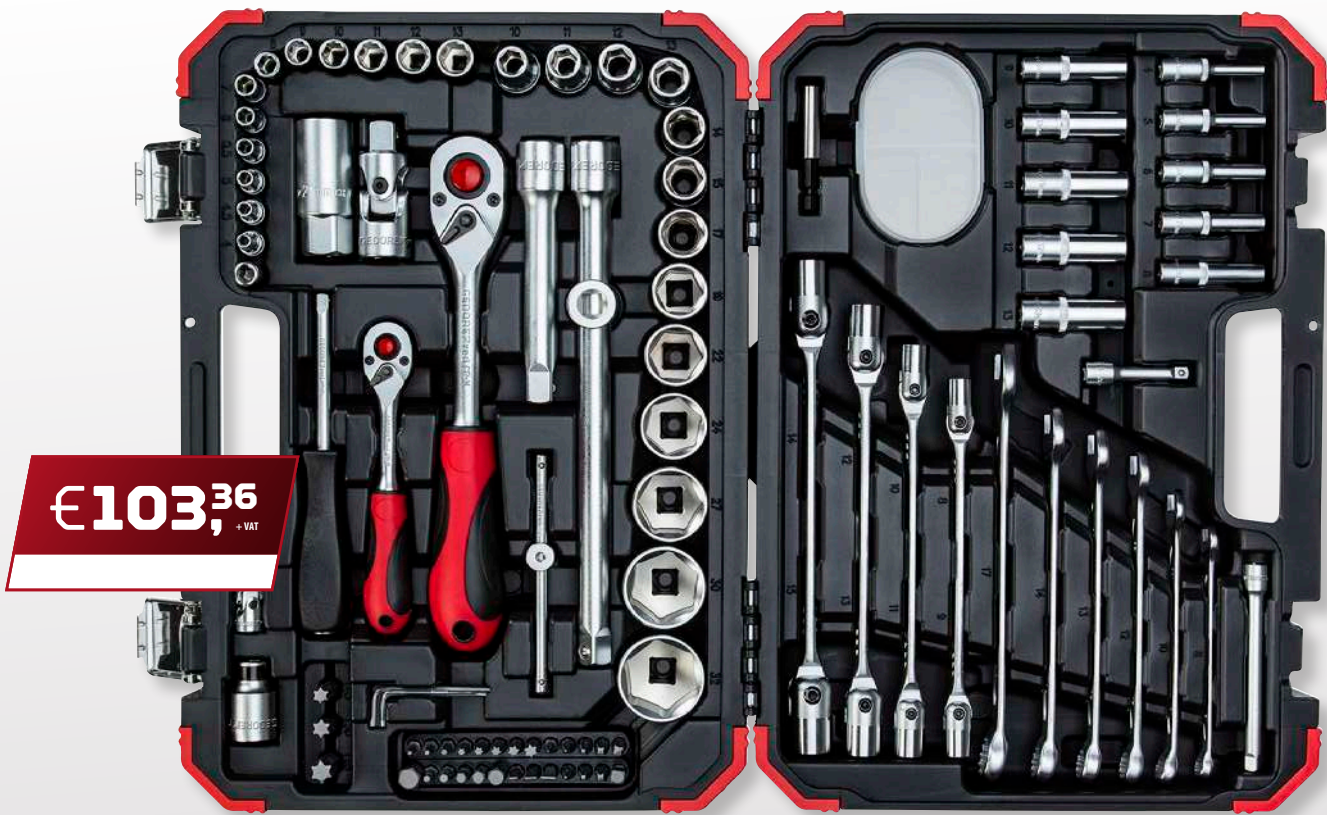

Code	No.	Contents	Width mm	Height mm	Depth mm	Pieces	Weight kg
3300062	R46003092	1/4" 2C-Lever Change reversible ratchet fine-toothed, 72 teeth   150 mm 1/4" Square plug-in handle   165 mm 1/4" Socket 4 4.5 5 5.5 6 7 8 9 10 11 12 13 mm 1/4" Socket 4 5 6 7 8 9 10 11 12 13 mm   50 mm 1/4" Socket extension 50 100 mm 1/4" Sliding T Bar   115 mm 1/4" Universal joint   32 mm Bit holder 1/4" hexagonal x 1/4" hexagonal, with magnet   60 mm Bit adaptor 1/4" square x 1/4" hexagon   25 mm Drive adaptor 1/4" hexagon x square with ball lock   25 mm 1/4" Bits hexagon socket 3 4 5 6 8 10   25 mm 1/4" Bits slotted 4 5, 5, 7   25 mm 1/4" Bits PH 0 1 2 3 4   25 mm 1/4" Bits PZ 1 2 3   25 mm 1/4" Bits TX T8 T10 T15 T20 T25 T27 T30 T40   25 mm 5/16" Bits TX T45 T50 T55   30 mm 1/2" 2C-Lever reversible ratchet fine-toothed, 72 teeth   250 mm 1/2" Socket 10 11 12 13 14 15 17 19 22 24 27 30 32 mm 1/2" Spark plug socket 21 mm (13/16")   65 mm 1/2" Socket extension 125 250 mm 1/2" Universal joint   65 mm Adaptor 3/8" x 1/2"   44 mm Bit adaptor 1/2" square x 5/16" hexagon   38 mm Double-jointed spanner 8x9 10x11 12x13 14x15 mm Combination spanner 8 10 12 13 14 17 mm Offset screwdriver hexagon 1.5 2.2.5 mm	383	83	280	92	5,85

**R4600 3097**

## 1/4"+1/2" SOCKET SET

97 pieces

› Ideal for all jobs for trades people  
or in the workshop

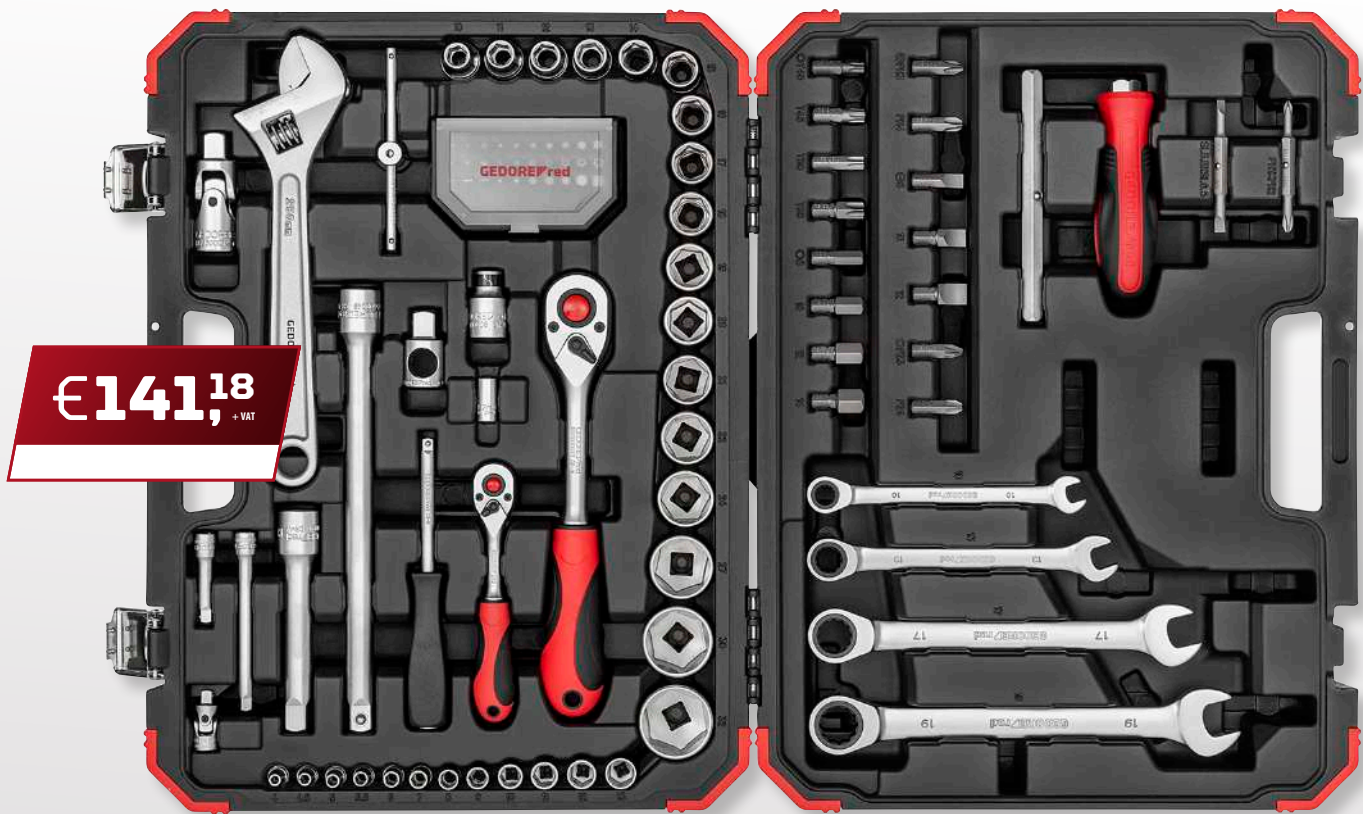

**€141,18**  
+ VAT



Code	No.	Contents	Width mm	Height mm	Depth mm	Pieces	Weight kg
<b>3300186</b>	R46003097	1/4" 2C-Lever reversible ratchet L 150 mm 1/4" Square handle L 165 mm 1/4" Socket, hexagon 4 4.5 5 5.5 6 7 8 9 10 11 12 13   25 mm 1/4" T-handle with slider L 115 mm 1/4" Socket extension L 50 100 mm 1/4" Universal joint L 33 mm 1/2" 2C-Reversible ratchet L 250 mm 1/2" Socket hex 10 11 12 13 14 15 16 17 18 19 20 21 22 24   38 mm 27 30 32   42 mm 1/2" Socket extension L 125 250 mm 1/2" Universal joint L 66 mm Adaptor 3/8" x 1/2" 1/4" Bit adaptor 1/2" Bit adaptor 1/4" Bits, L25mm, hexagon socket 2 3 4 5 5.5 6 mm, slot 4 5.5 6 mm, PH 1 2 3, PZ 1 2 3, TX T10 T15 T20 T25 T27 T30 T40, TXB T10 T15 T20 T25 T27 T30 T40 5/16" Bits L30mm, hexagon socket 8 10 12 14 mm, slot 8 10 12 mm, PH 3 4, PZ 3 4, TX T40 T45 T50 T55 Combination ratchet spanner SW 10 13 17 19 mm 2-Component handle Maximus, 5/16" shank with bit double blade PH 1 2, bit double blade 5.5 6.5 mm, bit adapter 8mm (5/16") x 1/4" Adjustable wrench, adjustable 30 mm, L 250 mm	452	86	340	97	8,9

**R4600 3232**  
**1/4"+1/2" SOCKET SET**  
 232 pieces

› Ideal for all jobs for tradespeople  
 or in the workshop

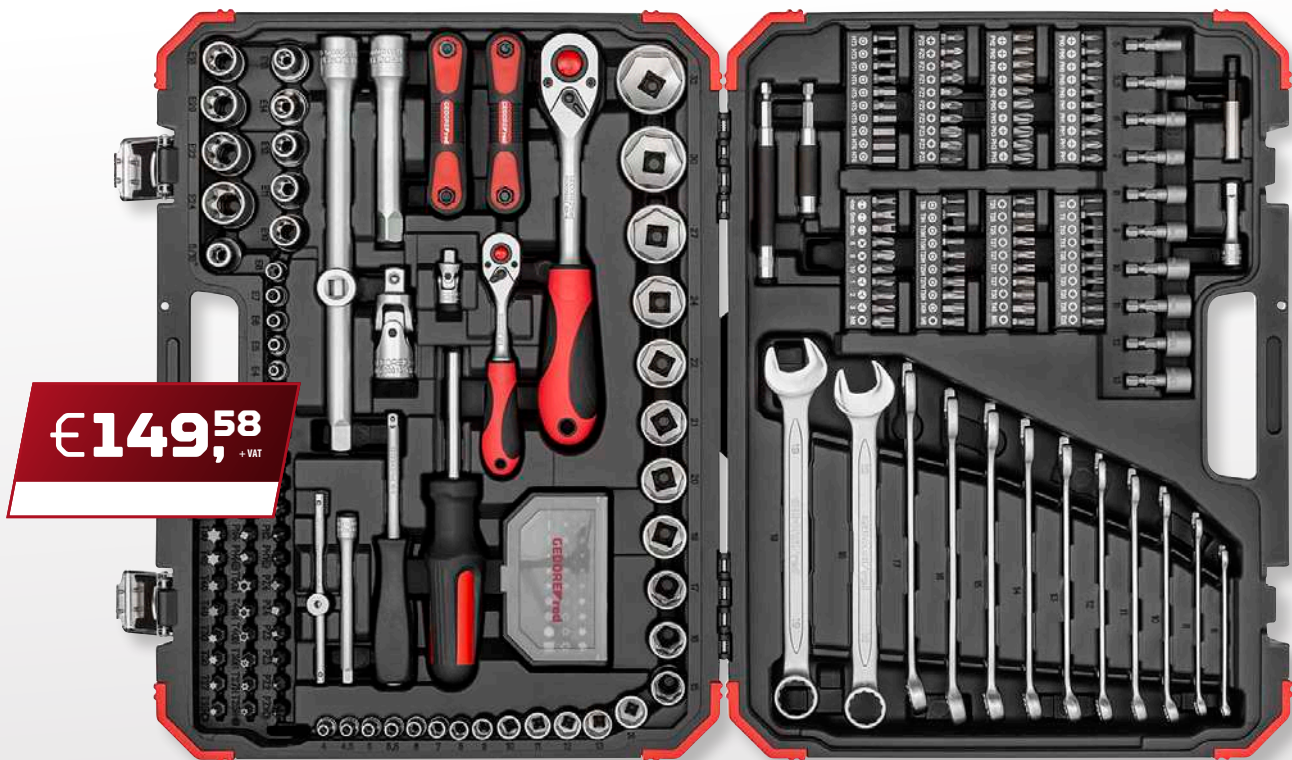

Code	No.	Contents	Width mm	Height mm	Depth mm	Pieces	Weight kg
<b>3300185</b>	R46003232	2C-1/4" Reversible ratchet length 150 mm Return angle 5° 2C-1/2" Reversible ratchet length 250 mm Return angle 5° 1/4" Sockets 4 4.5 5 5.5 6 7 8 9 10 11 12 13 14   25 mm 1/2" Sockets 15 16 17 19 20 21 22 24   38 mm 1/2" Sockets 27 30 32   42 mm 1/4" T-handle with slider 1/4" Socket extension 50 100 mm 1/2" Socket extension 125 - 250 mm 1/4" Universal joint length 33 mm 1/2" Universal joint length 66 mm 1/4" Square socket handle 165 mm 1/4" Sockets TX E4 E5 E6 E7 E8   25mm 1/2" Sockets TX E10 E11 E12 E14 E16 E18 E20   38mm, E22 L 40mm, E24 L41mm Adator 3/8" x 1/2" 1/2" Bit adaptor square x 5/16" hexagon 1/4" Bit screwdriver L 100 mm 1/4" Bits 25 mm long: Hexagon socket 3 4 5 6, PH 5x 0 1 2 3 each, PZ 2x 0 1 each 3x 2 3, TX T8 T9 T10 T15 T20 T25 T27 T30 TXB T40 T9 T10 T15 T20 T25 T27 T30 T40 Spanner 5 6 8 XZN 4 6 8 TRI-WING 1 2 3 Torque 6 8 10 1/4" Bits hex 38 mm long 5 5.5 6 7 8 9 10 11 12 13 mm 1/4" Bit holder 60+80+120mm 30-piece Bit box with 1/4" bits, 25 mm long: internal hexagon 2 3 4 5 5.5 6 mm, slot 4 5.5 6 mm, PH 1 2 3, PZ 1 2 3, TX T10 T15 5xT20 4xT25 4xT27 T30 T40, TXB T10 T15 T20 T25 T27 T30 T40 5/16" Bits 30 mm long: slotted 6 6.5 8, PH 1 2 2x3 4 each, PZ 1 2 2x3 4 each, TX T25 T27 T30 T40 T45 T50, TXB T 25 T27 T30 T40 T5 T45 Combination wrench 6 8 10 11 12 13 14 15 16 17 18 19 mm Offset screwdriver 1.5 2 2.5 3 4 5 6 8 mm Offset screwdriver TX T9 T10 T15 T20 T25 T27 T30 T40 Insert holder 1/4" square x 1/4" hex length 25mm	452	86	340	232	8,9

**R4560 3172**  
**1/4", 3/8" & 1/2"**  
**SOCKET SET**  
 172 pieces

› Ideal for all jobs with maintenance work, for trades people or in the workshop

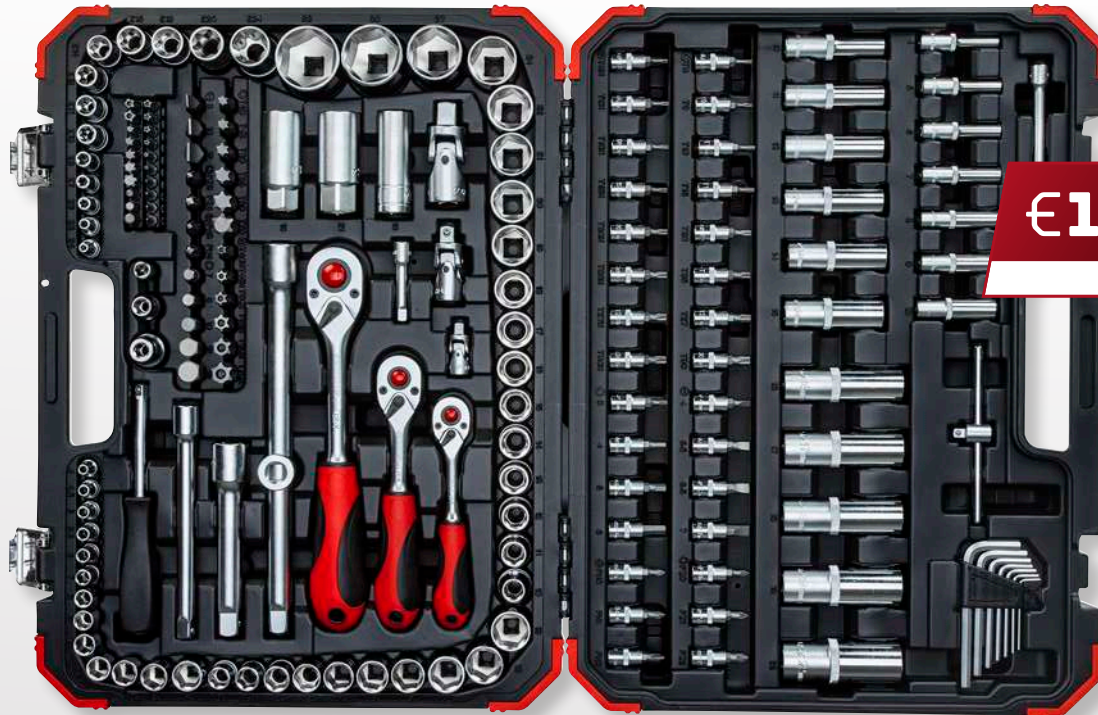

**€121,85**  
 + VAT

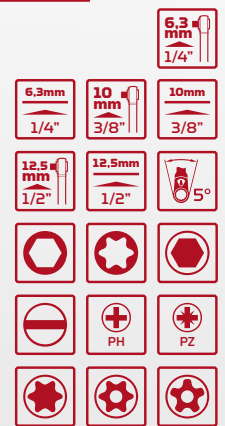

Code	No.	Contents	Width mm	Height mm	Depth mm	Pieces	Weight kg
3300058	R45603172	1/4" 2C-Lever-action ratchet fine-toothed, 72 teeth   150 mm 1/4" Square socket handle 165 mm 1/4" Socket hexagonal 4 4,5,5,5 6 7 8 9 10 11 12 13 14   25 mm 1/4" Socket hexagonal 4 5 6 7 8 9 10   50 mm 1/4" Socket TX E4 E5 E6 E7 E8   25 mm 1/4" Screwdriver bit socket hexagonal 3 4 5 6   37 mm 1/4" Screwdriver bit slotted 4 5,5 6,5 7   37 mm 1/4" Screwdriver bit PH 0 1 2   37 mm, 1/4" Screwdriver bit PZ 0 1 2   37 mm 1/4" Screwdriver bit socket TX T8 T9 T10 T15 T20 T25 T27 T30   37 mm 1/4" Screwdriver bit socket TX with hole T8 T9 T10 T15 T20 T25 T27 T30   37 mm 1/4" Socket extension 50 100 mm 1/4" Sliding T Bar   115 mm, 1/4" Universal joint   32 mm Bit adaptor 1/4" square x 1/4" hex   25 mm 1/4" Bits TX T5 T6 T7   25 mm 1/4" Bits TX with hole T7   25 mm 1/4" Bits TX plus security T10 T15 T20 T25 T27 T30 T40 T45   25 mm 1/4" Bits multi-tooth XZN M5 M6 M8   25 mm 1/4" Bits keyway M5 M6 M7 M8 M9   25 mm 5/16" Bits hexagon socket 7 8 10 12 14   30 mm 5/16" Bits slotted 8 10 12   30 mm 5/16" Bits PH 3 4   30 mm, 5/16" Bits PZ 3 4   30 mm 5/16" Bits TX T40 T45 T50 T55 T60 T70   30 mm 5/16" Bits TX with hole T40 T45 T50 T55 T60 T70   30 mm 3/8" 2C-Lever ratchet fine toothed, 72 teeth   180 mm 3/8" Hexagon socket 10 11 12 13 14 15 16 17 18 19 3/8" Hexagon socket 10 11 12 13 14 15   63 mm 3/8" Socket TX E10 E11 E12 E14 E16 E18 3/8" Spark plug socket 18 mm   65 mm 3/8" Socket extension 150 mm 3/8" Universal joint   49 mm Bit adaptor 3/8" 4kt x 5/16" 6kt   30 mm 1/2" 2C-Lever ratchet fine toothed, 72 teeth   250 mm 1/2" Socket hexagon 10 11 12 13 14 15 16 17 18 19 20 21 22 24 27 30 3 2 1/2" Socket hexagon 16 17 18 19 22   77 mm 1/2" Socket TX E20 E24, 1/2" Spark plug socket 16 21 mm   65 mm 1/2" Socket extension 125 250 mm 1/2" Universal joint   66 mm, Adaptor 3/8" x 1/2"   44 mm Bit adaptor 1/2" square x 5/16" hex   38 mm Offset screwdriver set hex 1.5 2 2.5 3 4 5 6 mm	450	93	345	172	10,5

## R3800 3043 TOOL SET „MEASURING- CUTTING-SCREWS“

43 pieces

› Ideal as basic equipment for tradespeople and DIYers

**€111,76**  
+ VAT



Code	No.	Contents	Width mm	Height mm	Depth mm	Pieces	Weight kg
3300190	R38003043	Screwdriver slotted 3 x 75 mm Screwdriver slotted with striking cap 4x75 mm, 5.5x100 mm, 6.5x125 mm Phillips screwdriver with striking cap PH 1x75 mm, PH 2x100 mm Offset screwdriver set 9 pcs hexagon socket, 1.5 2.2.5 3 4 5 6 8 10 long Offset screwdriver set 9 pcs TX T10 T15 T20 T25 T27 T30 T40 T45 T50 Tape measure 5m, Side cutters, Needle nose pliers straight Combination pliers, Level 300mm, Cutter knife incl. 3 blades 10 Replacement blades for cutter knives	383	80	272	43	6,2

## R6890 3011 WHEEL MOUN- TING SET

11 pieces

**€197,48**  
+ VAT



› The universal wheel mounting set impresses with precision and flexibility  
› Includes torque wrenches for cars/ SUVs/vans with 40-200 Nm



Code	No.	Contents	Width mm	Height mm	Depth mm	Pieces	Weight kg
3300400	R68903011	1/2" 2C-Telescopic ratchet 460-600 mm 1/2" Socket extension 75 mm + 125 mm 1/2" Impact sockets, hexagon with protective sleeve 17 mm + 19 mm Tyre tread depth gauge red/black Magnetic dish White tyre marking chalk Wheel bolt bag red/black Blow-moulded storage case (520x280x100mm) Torque wrench 1/2" 40 - 200 Nm	540	145	290	11	5,7



**R2170 2013**  
**ON THE ROAD BIKE SET**  
 13 pieces



- > Ergonomic handling with bit ratchet and bit adapter
- > Selection of bits and sockets tailored to the screws and nuts on a bike
- > Clampable bag on the saddle and seat post

**€33,27**  
 + VAT



Code	No.	Contents	Width mm	Height mm	Depth mm	Pieces	Weight kg
3300194	R21702013	Tire lever set, 3 pieces Bit hexagon socket 3 4 5 6 Bit PH1 Bit TX T25 Socket 10 mm Ratchet 1/4" Drive adaptor Bit holder with quick release system 66.5 mm Pocket	90	145	54	13	0,24

# R4600 7138 UNIVERSAL SET ALLROUND IN TOOL CASE

138 pieces

> Extensive range of tools for use around the home



€415,97 + VAT



Kneeboard



Code	No.	Contents	Width mm	Height mm	Depth mm	Pieces	Weight kg
3300189	R46007138	2C-Lever reversible ratchet 1/4" fine-toothed, 72 teeth   150 mm 2C-Lever reversible ratchet 1/2" fine-toothed, 72 teeth   250 mm 1/4" Socket 4 4.5 5 5.5 6 7 8 9 10 11 12 13 14   25 mm 1/2" Socket 10 13 14 16 17 18 19 20 22 24   38 mm 1/2" Socket 27 30 32   42 mm 1/4" Socket extensions 50 100 mm 1/2" Socket extensions 125 250mm 1/4" Square plug-in handle   165 mm 1/2" Spark plug socket SW 16 24   65 mm 1/4" T-handle with slider   115 mm 1/4" Universal joint   33 mm 1/2" Universal joint   66 mm Drive adaptor 1/4" square socket x 1/4" hexagon   25mm Drive adaptor 1/4" square x 1/4" hexagon   50mm Combination spanner 8 9 10 11 13 14 17 19 mm Adjustable spanner, 10"   250 mm Offset screwdriver set hexagon 2 2.5 3 4 5 6 8 10 mm Offset screwdriver set TX. long T10 T15 T20 T25 T30 T40 T45 T50 Screwdriver slot 5.5 6.5 8 Screwdriver Phillips PH 1 2 VDE Screwdriver PH 2 PZ 2 Phase tester slot 120-250 V 1/4" Ratchet screwdriver 1/4" Bit box internal hexagon SW 2 3 4 5 5.5 6 mm, slotted 4 5.5 6 mm, PH 1 2 3, PZ 1 2 3, TX T10 T15 T20 T25 T27 T30 T40, TXB T10 T15 T20 T25 T27 T30 T40 Combination pliers 180 mm Side cutters 160 mm Needle nose pliers 200 mm Water pump pliers 250 mm Crimping tool and plastic box with accessories 40 pcs. File, half-round, cut 2   200mm LED Flashlight   175mm Chisel set in plastic holder, 5 pieces Cutter knife with 10 spare blades Hacksaw 150 mm, plus 3 spare saw blades Machinist's hammer 300 g Tape measure, 5 m Universal scissors, blade length 60 mm Kneeboard Spirit level   300mm	455	157	355	138	13

**GEDORE** red

# 101-PIECE TOOL CASE - THE MASTERPIECE

**NEW**

Extensive tool assortment for construction and maintenance work.

The GEDORE red **Master XL R21652101** – your indispensable partner for mobile construction and maintenance work!

With 101 top quality tools, including a 32-piece bit box as well as combination ratchet wrench and water pump pliers, you have the right tool at hand at all times. The extremely sturdy, water-tight and stackable case protects your equipment and provides plenty of extra storage space for additional tools. The integrated tool panels provide a clear overview and effortless access. With the integrated gas pressure springs the tool case stays open, so unintentional closing is a thing of the past. Master your daily tasks in a jiffy with the GEDORE red Master XL.



Master XL tool case – R21652101

**1** MAXIMUM OVERVIEW AND EFFORTLESS TOOL ACCESS

**2** STURDY AND WATER-TIGHT CASE

**3** EXTRA-BIG STORAGE SPACE

**4** 101-PIECE ASSORTMENT FOR CONSTRUCTION AND MAINTENANCE WORK

SCREWING, LOOSENING, CUTTING AND MEASURING



**R2165 2101**  
**MASTER TOOL CASE XL**  
 101 pieces



- > Complete tradesperson assortment for screwing, loosening, cutting, measuring and many more jobs and challenges on the building site
- > Ergonomic 2C carrying handle ensures easy and relaxed tool transport
- > The 2 integrated gas pressure springs keep the case open and protect it from sudden closing
- > Extra storage space with tool panels, including insert bag for clearer overview
- > Strengthened lugs for every kind of padlock

**€449,00**  
 + VAT

Code	No.	Contents	Width mm	Height mm	Depth mm	Pieces	Weight kg
3301639	R21652101	Bit-Box 1/4" 32 pieces, slot PH PZ TX hexagon Socket set 1/4", 46 pieces 4-14 mm Combination ratchet spanner set 5 pieces 8-19 mm 2C-Bit screwdriver 1/4" 100 mm 2C-Screwdriver slotted 4 5,5 6,5 mm 2C-Screwdriver PH1 PH2 2C-Screwdriver PZ1 PZ2 Voltage tester 220-250V slot 3,5 mm 2C-Combination pliers 180 mm 2C-Power side cutter 180 mm Water pump pliers 10", 7-way adjustable Flat chisel flat oval 200 x 24 x 13 mm Spatula 60 mm Wood sectioned folding ruler 2 m Class III Spirit level 300 mm Engineer's hammer 300 g 300 mm ash	485	414	212	101	11,85

**NEW**

# 89-PIECE TOOL CASE - SAFETY FOR EVERY CHALLENGE

Versatile tool assortment for use on electrical systems.

With the **Electrician tool case R21652089** electrical professionals are totally in control! From everyday water pump pliers through to bit sets – 89 top quality tools for

every challenge on the most diverse electrical systems. The sturdy and water-tight case provides plenty of extra storage space. Thanks to the integrated tool panel you'll find everything in a jiffy. The integrated gas pressure springs prevent the case from unintentionally closing and provide even more safety. The ideal companion for installations on power and control systems!



Electrician tool case – R21652089

**1** MAXIMUM OVERVIEW  
AND EFFORTLESS  
ACCESS

**2** STURDY AND  
WATER-TIGHT CASE

**3** 89-PIECE TOOL  
ASSORTMENT FOR  
WORKING ON  
ELECTRICAL SYSTEMS



**STURDY  
COMPANION**

**R2165 2089**  
**TOOL CASE ELECTRICIAN**  
 89 pieces



- › Practical selection of tools for numerous installations on different systems (electrical)
- › Extremely sturdy case, pressure, dust and water-tight, also ideal for air travel
- › Optimum overview and access to the tool, sudden case closing prevented with gas pressure springs
- › Extra-big storage space and clearer overview with tool panels including insert bag
- › Lockable with padlocks

**€499,00**  
 + VAT

Code	No.	Contents	Width mm	Height mm	Depth mm	Pieces	Weight kg
3301643	R21652089	Bit-Box 1/4" 32 pieces, slot PH PZ TX hexagon Socket set 1/4", 33 pieces 4-13 mm Combination ratchet spanner set, 5 pieces 8-19 mm 2C-Bit screwdriver 1/4" 100 mm Screwdriver VDE slot 3x0.5x100 4x0.8x100 5,5x1x125 Screwdriver VDE PH1 PH2 Screwdriver VDE PZ1 PZ2 Voltage tester 220-250V slot 3,5mm 2C-Side cutter VDE 180 mm 2C-Telephone plier VDE 200 mm 45° Wire stripper StrippMax-Auto Water pump pliers 10", 7-way adjustable Spatula 60 mm Utility knife 18 mm Wood sectioned folding ruler 2 m Class III Spirit level 300 mm Engineer's hammer 300 g 300 mm ash	485	414	212	89	12,54

# MAXIMUM OVERVIEW AND EFFORTLESS ACCESS TO YOUR TOOLS

**NEW**

72-piece tool trolley SH&AC – mobile companion for sanitary, heating and air-conditioning systems. Sturdy tool assortment for daily use in the sanitary trade.

The perfect partner for sanitary professionals: The GEDORE red **tool trolley SH&AC R21902072!** Gripping, tightening, loosening, testing – with the 72-piece tool assortment for sanitary, heating and air-conditioning area professionals, they want for absolutely nothing. From Allen keys to sockets through to pliers wrench – the most important tools for day-to-day work are stored away safely in the sturdy and water-tight trolley. It provides plenty of extra storage space for additional tools, while the integrated tool panels provide the user a quick overview and effortless access. Thanks to the gas pressure springs, unintentional closing is a thing of the past.



Tool trolley SH&AC – R21902072

**1** STURDY AND WATER-TIGHT TROLLEY

**2** 72-PIECE TOOL ASSORTMENT FOR PROFESSIONALS IN THE SANITARY AREA

**SCREWING TOOLS ON CASTORS**

**R2190 2072**  
**PLUMBERS**  
**TOOL TROLLEY**  
 72 pieces

- > 72-piece tool assortment for all standard work in the plumbing, heating and air-con area
- > For mobile use, and for air transport
- > Sturdy, dust and water-tight tool trolley
- > Lockable with padlocks



**€599,00**  
 + VAT

Code	No.	Contents	Width mm	Height mm	Depth mm	Pieces	Weight kg
3301644	R21902072	Socket set 1/4", 33 pieces 4-13 mm Screwdriver VDE PH1 PH2 Screwdriver VDE PZ1 PZ2 Screwdriver VDE slot 3x0.5x100 4x0.8x100 5,5x1x125 Offset screwdriver set, 9 pieces TXT10-T50 Offset screwdriver set, 9 pieces hexagon 1,5-10 mm Voltage tester 220-250V slot 3,5mm 2C-Side cutter VDE 180 mm Pipe cutter copper pipe-Ø 3-35 mm Pipe wrench 1.1/2" 420 mm Pliers wrench 10" Water pump pliers 10", 7-way adjustable Flat chisel flat oval 250x25x13mm Spatula 60 mm Utility knife 18 mm Hacksaw 150 mm Wood sectioned folding ruler 2 m Class III Spirit level 300 mm Engineer's hammer 500 g 320 mm ash	550	350	225	72	14,97

**R4015 0027**  
**1/4" BIT RATCHET**  
 reversible, with drive adaptor

**€21,92**  
 + VAT

- > Lever for reversible clockwise/ anticlockwise operation
- > Fine-toothed
- > In-hex for direct mounting of bits as per DIN ISO 1173
- > With retention spring
- > Sturdy all-steel design
- > Driving adaptor hex x sq.



Code	No.	Drive square inch	Drive square mm	Length mm	Return angle	Number of teeth	Weight kg
3300161	R40150027	1/4"	6,3	91	6°	60	0,034

**R4017 0027**  
**2C-1/4" SWIVEL HEAD BIT RATCHET**  
 reversible

- > Ratchet head swivels through 180°
- > Lockable in various positions
- > In-hex for direct mounting of bits as per DIN ISO 1173



**€33,27**  
 + VAT



Code	No.	Drive connector hexagon female	Drive connector hexagon female mm	Return angle	Total length mm	Weight kg
3300160	R40170027	1/4"	6,3	5°	165	0,13

**RX005 00XX**  
**2C-REVERSIBLE RATCHETS**  
 cranked

- > Cranked version
- > Push-button release
- > For sockets, accessories etc. with square drive as per DIN 3120 - C 12,5, ISO 1174, with ball retention groove



from

**€22,76**  
 + VAT



Code	No.	Drive square inch	Drive connector square mm	Return angle	Total length mm	Weight kg	excl. VAT
3300159	R40050009	1/4"	6,3	10	146	0,1	22,76
3300225	R50050009	3/8"	10	10	210	0,226	30,41
3300411	R60050009	1/2"	12,5	10	253	0,514	31,34



**R6011 0009**  
**2G-1/2" SWIVEL-HEAD**  
**TELESCOPIC RATCHET**  
 reversible

- > Ratchet head swivels through 180°
- > Ring for reversing clockwise/anticlockwise direction
- > For sockets, accessories etc. with square drive as per DIN 3120 - C 12,5, ISO 1174, with ball retention groove



Code	No.	Square drive inch	Square drive mm	variable length mm	Return angle	Number of teeth	Weight kg
3300523	R60110009	1/2"	12,5	430-580	10°	36	1,292

**R6012 0027**  
**2G-1/2" SWIVEL HEAD**  
**REVERSIBLE RATCHET**

- > Ratchet head swivels through 180°
- > Push-button release
- > For sockets, accessories etc. with square drive as per DIN 3120 - C 12,5, ISO 1174, with ball retention groove



Code	No.	Drive connector square	Drive connector square mm	Return angle	Total length mm	Weight kg
3300409	R60120027	1/2"	12,5	5°	290	0,633



## RX890 XXXX TORQUE WRENCHES

5-550 Nm

- › Adjustable torque wrench with square drive and integrated ratchet function
- › Audible Torque triggering can clearly be heard and felt
- › Right-hand and left-hand tightening by changing the mushroom head / push-through square
- › Tripping accuracy: +/- 3 % tolerance of the set scale value



Code	No.	Type	Square drive inch	Square drive metric mm	Nm	Nonius	Height mm	Housing - square centre spacing mm	Length mm	Head width mm	Head height mm	Weight kg	excl. VAT.
3301214	R48900025	square socket with knob, serrated	1/4"	6,3	5-25	1	34	17,5	285	35,0	25,3	0,515	122,69
3301871	R58900050	square socket with knob, serrated	3/8"	10	10-50	2,5	34	17,5	330	35,0	25,3	0,476	122,69
3301216	R68900100	square socket with knob, serrated	1/2"	12,5	20-100	5	51,5	22	395	46,0	35,9	1,176	131,93
3301217	R68900200	square socket with knob, serrated	1/2"	12,5	40-200	10	45	22	485	46,0	35,9	1,42	134,45
3301218	R68900300	square socket with knob, serrated	1/2"	12,5	60-300	10	47	23	575	46,0	35,9	1,541	142,02
3301219	R78900400	Push-through square with pin	3/4"	20	80-400	10	51	31	680	62,5	38	2,39	226,89
3301220	R78900550	Push-through square with pin	3/4"	20	110-550	10	52	34,5	960	69,0	38	4,184	407,56



**R3800 2012**  
**SCREWDRIVER**  
**SET XXL**  
 12 pieces

**€44,61**  
 + VAT



- › Driven tips phosphated, corrosion-protected and low-wear
- › 2-component-handle for a hands-friendly transfer of force
- › 5-edge handle heads stop them rolling off when put down



Code	No.	Contents
3301273	R38002012	Screwdriver slot 3 4 5.5 6.5 8 mm, Screwdriver PH 1 2 Screwdriver PZ PZ 1 2, VDE Screwdriver slotted 2.5 mm VDE Screwdriver PH 1, Voltage tester 3 mm

Pieces	Weight kg
12	0,927

**R3800 2006**  
**SCREWDRIVER**  
**SET**  
 6 pieces

**€20,92**  
 + VAT



- › Driven tips phosphated, corrosion-protected and low-wear
- › 2-component-handle for a hands-friendly transfer of force
- › 5-sided grip heads prevent rolling away



Code	No.	Contents
3301270	R38002006	Screwdriver slotted 3 5.5 6.5 mm, Screwdriver PH 0 1 2

Pieces	Weight kg
6	0,435

**R3800 2106**  
**SCREWDRIVER**  
**SET**  
 6 pieces

**€20,92**  
 + VAT



- › Acc. to DIN 5264 and DIN 8764
- › Driven tips phosphated, corrosion-protected and low-wear
- › 2-component-handle for a hands-friendly transfer of force
- › 5-edge handle heads stop them rolling off when put down



Code	No.	Contents
3301271	R38002106	Screwdriver slotted 3 5.5 6.5 mm, Screwdriver PH 0 1 2

Pieces	Weight kg
6	0,435

# ALLEN KEYS WITH COLOUR CODING

The two 9-piece Allen key sets with the most popular used sizes for immediate overview in your day-to-day work.

The 9-piece GEDORE red Allen key sets R36401009 and R36601009 are simply perfect for tightening or loosening TX and hexagon head screws and bolts. With the 9 most popular used sizes (T10 - T50 or 1.5-10 mm) you are always best equipped for the most important screwing work. The round shape is comfy on the hand and ensures pleasant handling – in continuous use as well. The extra long handle means a greater leverage effect and makes it easier to apply force. The

R36601009 excels with its spherical head, with hard to reach screw connections as well. The colour coding means the right size can be found in a flash. Both sets come safely stored away in the plastic holder with practical belt clip – fold open for easier taking out.



Allen key set TX/IN, 9-piece – R36401009 and R36601009

**1** TIME-SAVING THANKS TO COLOUR CODING

**2** COMFORTABLE WORKING WITH LONG HANDLE

**3** HIGH CORROSION PROTECTION

*TAKE IT EASY*

**R3660 1009**  
**ALLEN KEY SET HEX**  
**WITH COLOUR CODING**  
 9 parts, long



**€18,06**  
 + VAT

- > Colour coded plastic coating to find the right L-key faster
- > Round shape
- > Long version with ball end
- > In a foldable holder with belt clip



Code	No.	Contents
3301332	R36601009	1.5 2 2.5 3 4 5 6 8 10 mm

Pieces	Weight kg
9	0,6

**R3640 1009**  
**ALLEN KEY SET TX**  
**WITH COLOUR CODING**  
 9 parts, long



**€20,83**  
 + VAT

- > Colour coded plastic coating to find the right L-key faster
- > Round shape
- > Long version
- > In a foldable holder with belt clip



Code	No.	Contents
3301333	R36401009	T10 T15 T20 T25 T27 T30 T40 T45 T50

Pieces	Weight kg
9	0,6

**R3800 5906**  
**2C-ELECTRONIC**  
**SCREWDRIVER**  
**SET**  
 6 pieces

**€20,92**  
 + VAT



- > 2C-handles, ergonomically formed, with quick-turning end caps
- > Screwdriver blades of chrome-molybdenum steel, chrome-plated



Code	No.	Contents
3301331	R38005906	Screwdriver slotted 1.5x60 2.0x60 2.5x60 3.0x60 mm Screwdriver PH 00x60 0x60

Pieces	Weight kg
6	0,37

**R3867 2006**  
**2GT-HANDLE**  
**ALLEN KEY SET**  
 In-hex, 6 pieces



- > Two-way profile
- > 2-component-handle for a hands-friendly transfer of force

**€31,84**  
 + VAT



Code	No.	Contents	Pieces	Weight kg
3301281	R38672006	Offset screwdriver 2.5 3 4 5 6 8 mm	6	0,731

**R3891 0000**  
**RATCHET SCREWDRIVER 1/4"**  
 with telescopic blade

- > Adjustable telescopic blade
- > Quick-grip system for hex bits as per DIN 3126 - C 6.3 + E 6.3 (1/4")
- > Reversible clockwise/anticlockwise ratchet function
- > Ratchet lock in central position



**€17,13**  
 + VAT



Code	No.	Drive connector hexagon female	Drive connector hexagon female mm	variable blade length mm	variable length	Weight kg
3301341	R38910000	1/4"	6,3	0 - 100	183-287	0,223

**R2215 0016**  
**VDE SCREWDRIVER SET**  
 in 1/3 module, 6 pieces

- > VDE-insulated acc. to DIN EN 60900
- > Guaranteed protection for working under voltage up to AC 1000 V (alternating current) and DC 1500 V (direct current)
- > 2-component-handle for a hands-friendly transfer of force
- > 5-edge handle head stops it rolling off when put down



**€53,10**  
 + VAT



Code	No.	Contents	Length mm	Width mm	Pieces	Weight kg
3301715	R22150016	VDE Screwdriver slotted 2.5 3 4 5.5 mm VDE Screwdriver Phillips PH 1 2	310	158	6	0,68

## R2015 2006 WORKSHOP TROLLEY MECHANIC

6 drawers, black, matt



- > Strong, sheet steel construction, torsionally rigid, designed to take high loads
- > 6 drawers with telescopic fully extending runners, with individual locking (one-hand operation)
- > Load capacity 25 kg per drawer, variable partitionable
- > Central locking with cylinder lock with 4 keys



Code	No.	RAL	Width mm	Height mm	Depth mm	Drawers	Max. load-bearing capacity kg	Number of drawers	Weight kg
3300012	R20152006	3020/7016	628	910	418	4 x H = 69 mm 1 x H = 144 mm 1 x H = 218 mm	210	6	56

## R2215 0020 3/8" SOCKET SET IN 2/6 CT-MODULE

18 pieces



- > Ideal for all automotive screw connection work
- > 2C-reversible ratchet 3/8": clockwise/anti-clockwise rotation can be switched using a lever, push-button release, fine-toothed, oval head, 2-component handle
- > Sockets 3/8" hex: metric, short, according to DIN 3124, ISO 2725

Code	No.	Contents	Width mm	Height mm	Depth mm	Pieces	Weight kg
3301726	R22150020	2C-Reversible ratchet 3/8" Socket 6 7 8 9 10 11 12 13 14 15 16 17 18 19 mm Sliding T bar Extension 125 mm Adaptor 3/8" to 1/2"	157	35	310	18	1,106

# ORGANISED HELPER FOR EVERY PROJECT

The workshop trolley GEDWorker provides easy drawer access from 2 sides and extra storage room.

With its 5 drawers and 1 storage compartment in the base, the GEDORE red **workshop trolley GEDWorker R20152205** ensures perfect order and plenty of space. Ideal in confined work areas: 2-way opening for easy access in the workshop or hobby room. The small parts compartments in the lid also ensure order and a clear overview on the trolley. Thanks to the externally fixed castors, with its 200 kg load bearing capacity, even when fully loaded the GEDWorker moves smoothly and safely, making it a reliable helper in every workshop. To top it all off the sturdy overall package also scores well with its tough powder coating in stylish black.



Workshop trolley GEDWorker R20152205

**1** COMPACT ORGANISATION  
TRAY IN THE LID

**2** SMOOTH-RUNNING  
DRAWERS

**3** EASY ACCESS  
FROM BOTH SIDES

**4** STURDY  
CHASSIS



**FLEXIBLE  
ACCESS**



**R2015 2205**  
**WORKSHOP TROLLEY**  
**GEDWORKER**  
 with 5 drawers

**€385,71**  
 + VAT



- > Sheet steel, corrosion-resistant and scratch-resistant powder-coated
- > Working platform with cover made of ABS plastic with 3 compartments for small parts
- > Central locking system
- > Ball-bearing guide rails
- > All drawers can be pulled out on both sides
- > Load capacity per drawer 20 kg
- > Additional storage compartment for larger items below the last drawer
- > The GEDORE trapezoidal axle construction secures smooth running, manoeuvrability and track-keeping also in case of maximum loads



Code	No.	RAL	Width mm	Height mm	Depth mm	Drawers	Max. load-bearing capacity kg	Number of drawers	Weight kg
3301675	R20152205	9005	685	963	462	2xType 1, H=74mm 3xType 2, H=119mm	200	5	41

# THE NAME SAYS IT ALL!

The fully equipped workshop trolley GEDWorker scores well with its extensive 119-piece basic equipment offering for numerous applications.

The basic assortment in the practical space miracle: Tool set in the workshop trolley GEDWorker R21562005. The extensive, 119-piece basic equipment from GEDORE red is spread over 5 drawers in the clear overview GEDORE red Check-Tool foam inserts and leaves you wanting for nothing. From hammer to pliers – the right tool for the tradesperson and DIYer. The sturdy organisation helper also scores well with a storage compartment in the base. The externally fixed castors and the highly stable chassis guarantee high stability and superb rolling characteristics. The 2-way drawer access is simply ideal for use in confined spatial conditions.



Tool set in workshop trolley GEDWorker, 119-piece – R21562005

**1** CLEAR OVERVIEW SMALL PARTS COMPARTMENTS

**2** DRAWERS' 2-WAY OPENING

**3** STURDY CHASSIS AND 200 KG LOAD BEARING CAPACITY

**4** FULLY EQUIPPED IN ONE TROLLEY



**STURDY ORGANIZATION HELPER**



# R2156 2005 TOOL SET IN WORKSHOP TROLLEY GEDWORKER

119 pieces



- > As basic equipment for the workshop, basic range for beginners of all professional groups or the experienced
- > Metric dimension tools
- > Clearly arranged in GEDORE red foam modules
- > With check tool system: Completeness check using 2-colored foam inserts

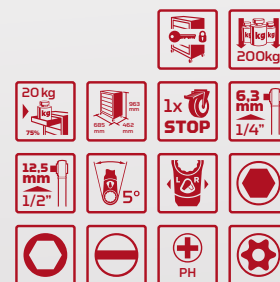

Code	No.	Contents	Width mm	Height mm	Depth mm	Pieces	Weight kg
3301676	R21562005	1/4" 2C-Lever reversible ratchet fine toothed, 72 teeth   150 mm 1/4" Driving handle 165 mm 1/4" Socket hexagon 4 4,5 5,5 6 7 8 9 10 11 12 13 1/4" Screwdriver bit socket for in-hex screws 3 4 5 6 8 10   37 mm 1/4" Screwdriver bit socket slot 5,5 6,5   37 mm 1/4" Screwdriver bit socket PH 1 2 3   37 mm 1/4" Screwdriver bit socket PZ 1 2   37 mm 1/4" Screwdriver bit socket TX with hole T10 T15 T20 T25 T27 T30 T40   37 mm 1/4" Extension 100 mm 1/4" Sliding T-bar with slider   115 mm 1/4" Universal joint   32 mm 1/2" 2C-Lever reversible ratchet fine toothed, 72 teeth   250 mm 1/2" Extension 125 250 mm 1/2" Sliding T-bar with slider 250 mm 1/2" Universal joint   66 mm 1/2" Socket hexagon 10 11 12 13 14 15 16 17 18 19 21 22 23 24 26 27 28 30 32 1/2" Screwdriver bit socket for in-hex screws 6 7 8 9 10 12 14   55 mm Screwdriver slotted 4 5,5 6,5 8 mm Screwdriver PH 1 2 Screwdriver T10 T15 T20 T25 T30 T40 Combination spanner 6 7 8 9 10 11 12 13 14 15 16 17 18 19 21 22 24 mm Hexagon socket 1,5 2 2,5 3 4 5 6 8 10 mm Engineer's hammer 300 g Flat chisel 125 mm 150 mm Cross cut chisel 125 mm Centre punch 4 mm   120 mm Pin punch 4 mm   120 mm Drift punch 3 mm   150 mm Water pump pliers 10"   250 mm Combination pliers 180 mm Telephone plier, gerade 160 mm Side cutter 160 mm Utility knife with 5 spare blades Measuring tape 3 m	685	963	462	119	55,46

**GEDORE red**

# THE ORGANISED COMPANION

The easy to manoeuvre and sturdy workshop trolley GEDMaster with 7 drawers and trendy design.

**Workshop trolley GEDMaster R20202207** from GEDORE red: 7 smooth-running drawers, 400 kg stable load capacity and a top quality chassis – you want for nothing here. Thanks to 2 different drawer heights, everything from pliers wrench to hammer through to the complete tool insert of all work equipment can be individually stored and organised with a clearly structured overview. Even when the drawers are fully loaded up to 40 kg the ball bearing-mounted guide rails ensure sleek and smooth-running opening. The GEDORE trapezoidal axle structure also ensures optimum rolling characteristics and stability at the point of use with 400 kg loading. The stylish powder coating in black complements the workshop trolley and makes it a tough but aesthetic companion for every purpose.



Werkstattwagen GEDMaster R20202207

**1** COMPACT ORGANISATION SECTION IN THE LID

**2** 400 KG LOAD BEARING CAPACITY

**3** 7 DRAWERS

**4** EASY TO MANOEUVRE AND SMOOTH-RUNNING





**R2020 2207**  
**WORKSHOP TROLLEY**  
**GEDMASTER**  
 with 7 drawers

**€671,43**  
 + VAT



- > Sheet steel, corrosion-resistant and scratch-resistant powder-coated
- > Working platform with cover made of ABS plastic with 4 compartments for small parts
- > Side panels with Euro perforation 10 x 38 mm for attaching accessories
- > Central locking with cylinder lock
- > Each drawer with safety locking, single-hand operation
- > All drawers with full extension and ball bearing guide rails
- > Load capacity per drawer 40 kg
- > The GEDORE trapezoidal axle construction secures smooth running, manoeuvrability and track-keeping also in case of maximum loads



Code	No.	RAL	Width mm	Height mm	Depth mm	Drawers	Max. load-bearing capacity kg	Number of drawers	Weight kg
<b>3301677</b>	R20202207	9005	790	999	470	5xType 1, H=70mm 2xType 2, H=145mm	400	7	65

# EASY TO MANOEUVRE ORGANISATION HELPER WITH A HUGE RANGE OF EQUIPMENT

With its 273-piece equipment offering, the filled workshop trolley offers everything the heart desires.

Everything the workshop heart desires – the GEDORE red workshop trolley GEDMaster R22071005 including 273-piece top quality equipment. The easy to manoeuvre organisation helper comes with a huge range of equipment: From bits to

hammer through to pliers, you want for nothing here. All the tools come in clear overview foam inserts with Check-Tool colour marking so you see everything immediately.

With a total load bearing capacity of 400 kg it can also be smoothly manoeuvred with additional loading or used stationary as an additional work surface. The top quality black powder coating gives it an aesthetic look and protects against corrosion and wear and tear.

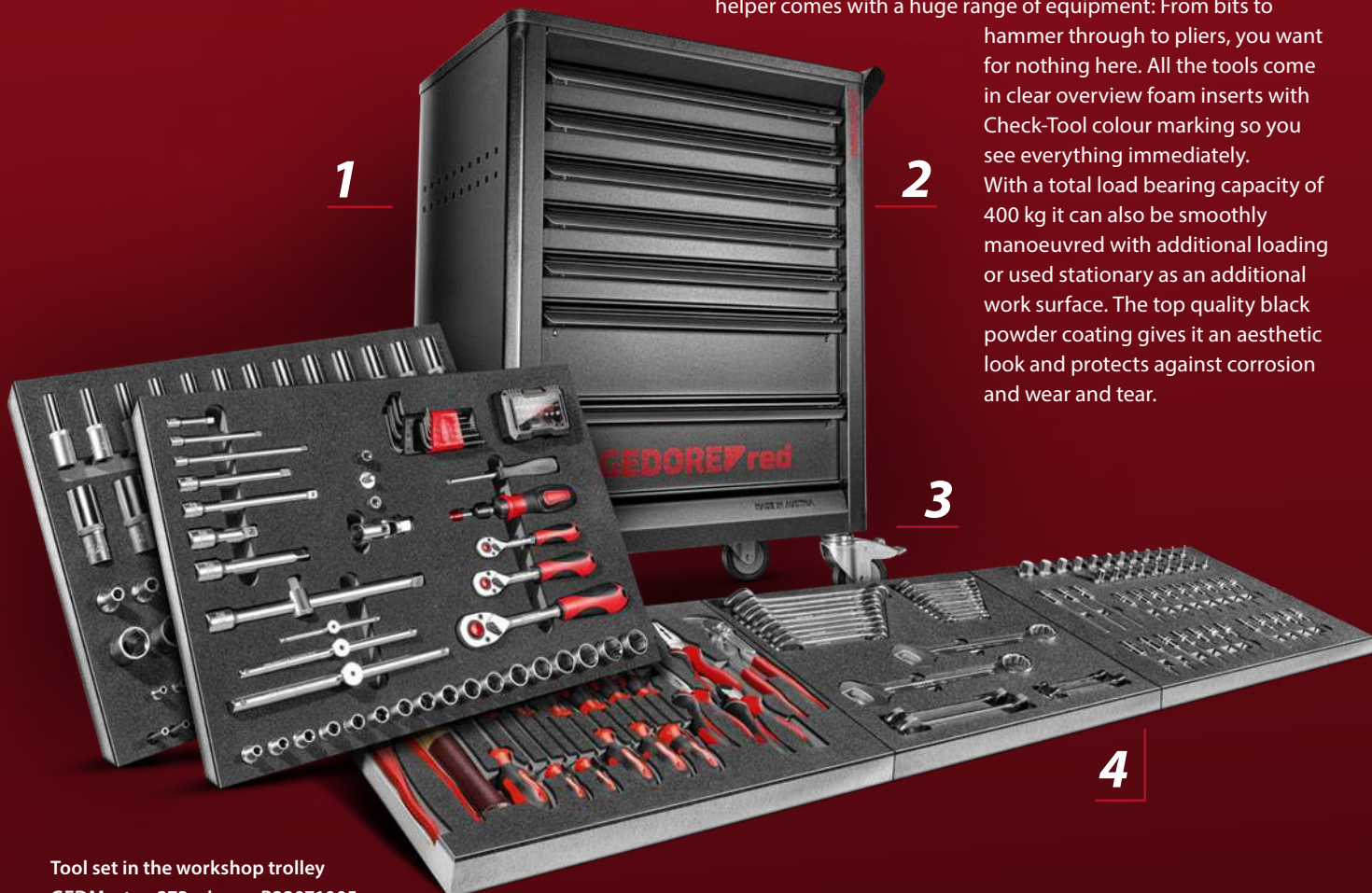

Tool set in the workshop trolley  
GEDMaster, 273-piece – R22071005

**1** 400 KG LOAD  
BEARING CAPACITY

**2** SAFE LOADING

**3** EASY TO MANOEUVRE  
AND SMOOTH-RUNNING

**4** FULLY EQUIPPED



SET UP FOR  
EVERYTHING

**R2207 1005**  
**TOOL SET IN**  
**WORKSHOP TROLLEY**  
**GEDMASTER**  
 273 pieces

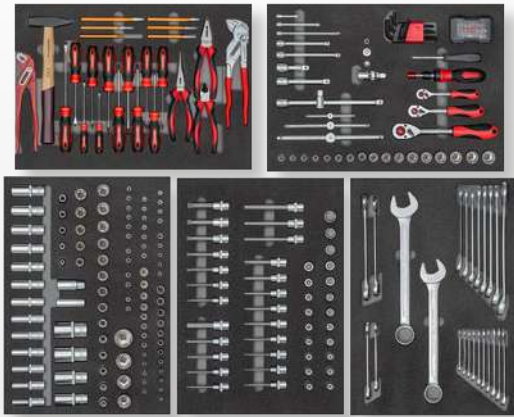

- › Extensive range for industry, trade, automotive and the advanced do-it-yourselfer
- › Metric dimension tools
- › Clearly arranged in GEDORE red foam modules
- › With check tool system: Completeness check using 2-colored foam inserts

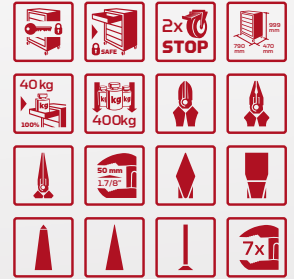

Code	No.	Contents	Width mm	Height mm	Depth mm	Pieces	Weight kg
3301678	R22071005	Tool trolley GEDMaster 7 drawers 1/4" 2C-Reversible ratchet L.150mm, 1/4" Extension L.50mm 1/4" Extension L.100mm 1/4" Extension L.150mm, 1/4" Sliding T-bar with slider L.115mm 1/4" Universal joint L.33mm, 1/4" Driving handle L.62mm 2C-handle 1/4" Bit-Adapter square x hexagon L.24.7mm 1/4" Bit-Box SL+PH+PZ+TX+hexagon 32 pcs 1/4" Ratchet screwdriver with telescopic blade 3/8" 2C-Reversible ratchet L.180mm 3/8" Socket hexagon 6 7 8 9 10 11 12 13 14 15 16 17 18 19 20 21 22 3/8" Extension L.125mm 3/8" Extension L.150mm, 3/8" Sliding T-bar with slider Convertor 3/8" x 1/2" square L.44mm, Reducer 3/8" to 1/4" 1/2" 2C-Reversible ratchet L.250mm, 1/2" Universal joint L.66mm 1/2" Extension L.75mm, 1/2" Extension L.125m 1/2" Extension L.250m, 1/2" Sliding T-bar with slider Hexagon socket key set hexagon.5-10mm 9 pcs 1/4" Socket hexagon 4 4,5 5 5,5 6 7 8 9 10 11 12 13 14 L.25mm 1/4" Socket hexagon 4 4,5 5 5,5 6 7 8 9 10 11 12 13 L.50mm 1/4" Socket TX E5 E6 E7 E8 E10 L.25mm 1/4" Screwdriver bit socket 3 4 5 6 L.37mm 1/4" Screwdriver bit socket PH1 PH2 L.37mm 1/4" Screwdriver bit socket PZ1 PZ2 L.37mm 1/4" Screwdriver bit socket SC 5,5 6,5 L.37mm 1/4" Screwdriver bit socket TX B0 T10 T15 T20 T25 T27 T30 1/4" Screwdriver bit socket TX T10 T15 T20 T25 T27 T30 T40 1/2" Socket hexagon 8 9 10 11 12 13 14 15 16 17 18 19 20 21 22 24 27 32 1/2" Socket hexagon 10 11 12 13 14 15 16 17 18 19 20 21 22 24 27 30 32 1/2" Socket TX E8 E10 E11 E12 E14 E16 E18 E20 E22 E24 1/2" Spark plug socket 16 21 1/2" Screwdriver bit socket 4 5 6 7 8 9 10 11 12 14 17 19 L.55mm 1/2" Screwdriver bit socket 5 6 7 8 10 12 14 17 L.100mm 1/2" Screwdriver bit socket TX T20 T25 T27 T30 T40 T45 T50 T55 T60 L.55mm 1/2" Screwdriver bit socket TX T20 T25 T27 T30 T40 T45 T50 T55 T60 L.100mm 1/2" Screwdriver bit socket XZN M5 M6 M8 M10 M12 M14 M16 Combination pliers L.180mm 2C-handle, Side cutter L.160mm 2C-handle Telephone plier straight L.200mm 2C-handle, 2C-Screwdriver slot 3 4 5,5 6,5, 2C-Screwdriver PH1 PH2, 2C-Screwdriver TX T10 T15 T20 T25 T30 T40 Water pump pliers 10", Engineer's hammer 300g L.300mm, Drift punch octagonal 120x4mm Ø12mm, Centre punch octagonal 120x4mm Ø10mm Pin punch octagonal 150x4mm Ø10mm, Flat chisel flat oval 125x15x9mm, Flat chisel flat oval 150x18x11mm Cross cut chisel flat oval, Pliers wrench 10" Combination spanner 6 7 8 9 10 11 12 13 14 15 16 17 18 19 20 21 22 24 27 30 32 Combination ratchet spanner 10 13 17 19	790	999	470	273	88,5

## R9210 XXXX ENGINEERS' HAMMER

from

€9,49  
+ VAT



- > Drop-forged hammer head, black paint-finished, of heat-treated steel
- > Striking surfaces inductively case-hardened for tough long-term work
- > 360° clamping force of the tapered collar fixes the hammer head

Code	No.	Head weight g	Length mm	Weight kg	excl. VAT
3300712	R92100012	300	300	0,432	9,49
3300714	R92100020	500	320	0,622	12,34
3300715	R92100032	800	350	0,95	13,52

## R9000 0006 CHISEL & PUNCH SET

6 pieces

€23,77  
+ VAT



- > Tempered striking ends
- > Made from chrome-vanadium steel



Code	No.	Contents	Length mm	Width mm	Height mm	Pieces	Weight kg
3300826	R90000006	Flat cold chisel - length 125 150 mm Cross-cut chisel - length 125 mm Drift punch - Ø 3 mm Centre punch - Ø 4 mm, Pin punch - Ø 4 mm	170	110	30	6	0,76

## R9020 0006 PIN PUNCH SET

6 pieces

€23,77  
+ VAT



- > Acc. to DIN 6450
- > Tempered striking ends
- > Made from chrome-vanadium steel



Code	No.	Contents	Length mm	Width mm	Height mm	Pieces	Weight kg
3300823	R90200006	Pin punch Ø 3 4 5 6 7 8 mm	170	115	30	6	0,8

**R2815 4010**  
**WATER PUMP PLIERS**  
 automatic one-hand adjustment

**€18,98**  
 + VAT



- > Automatic setting mechanism for one-handed operation
- > Push-through joint, high stability
- > Lengthways-serrated grip surfaces



Code	No.	Clamping reach mm	Length inch	Length mm	Weight kg
3301172	R28154010	35	10	250	0,374

**R2818 4010**  
**PLIER WRENCH**

**€44,61**  
 + VAT



- > Pliers and wrench in one tool
- > Maximum capacity: 50mm or 1.7/8"
- > 17 setting positions
- > According to DIN ISO 5743



Code	No.	Clamping reach mm	Length mm	Weight kg
3300016	R28184010	50	260	0,533

**R2800 2003**  
**PLIER SET**  
 3 pieces

**€40,83**  
 + VAT



- > Induction-hardened cutting edges
- > 2-component-handle for a hands-friendly transfer of force
- > Chrome-vanadium steel



Code	No.	Contents	Pieces	Weight kg
3301155	R28002003	Combination pliers 180 mm, Side cutter 160 mm, Telephone pliers, straight 200 mm	3	0,711

**R2800 2004**  
**PLIER SET**  
 4 pieces

**€37,97**  
 + VAT



- > External circlip pliers straight and angled
- > Internal circlip pliers straight and angled
- > Dip-coated handle covers



Code	No.	Contents
3301156	R28002004	External circlip pliers straight A2, External circlip pliers angled A21 Internal circlip pliers straight J2, Internal circlip pliers angled J21

Pieces	Weight kg
4	0,68

**R2820 1165**  
**STRIPPMAX-AUTO**  
**WIRE STRIPPER**

**€18,98**  
 + VAT



- > For all common flexible and solid conductors from 0.2 - 6.0 mm<sup>2</sup>
- > Integrated, easily accessible side cutter up to 2 mm Ø
- > Ergonomic Handling
- > Made from glass fibre reinforced polyamide and high quality knife steel from Solingen



Code	No.	Length mm	Cable cross-section mm <sup>2</sup>
3300197	R28201165	165	0,2-6

Weight kg
0,107

**R3900 2005**  
**VDE TOOL**  
**ASSORTMENT**  
 5 pieces

**€52,26**  
 + VAT



- > VDE-insulated acc. to DIN EN 60900
- > Guaranteed protection when working under voltage up to 1,000 V AC (alternating voltage) and 1,500 V DC (direct voltage)
- > 2-component-handle for a hands-friendly transfer of force



Code	No.	Contents
3301414	R39002005	VDE Screwdriver slotted 3, 5.5 mm, VDE Screwdriver PH 2 VDE Side cutter 180 mm, VDE Telephone pliers 200 mm, straight pattern

Pieces	Weight kg
5	0,833



**GEDORE**  **red**

# ***OPTIMAL SOLUTIONS FOR EVERY CONSTRUCTION SITE***

**LED SELECTION**



Whether in the workshop, on the construction site or at home: The **GEDORE red** light range offers the right solution for every situation. The various models ensure optimum illumination and ideal working conditions at every angle thanks to their powerful light output.



**R9530 0139**  
PEN LAMP

**€17,22**  
+ VAT

- > Compact, slim size
- > Good grip even with oily and sweaty hands
- > Can also be used with gloves
- > Practical clip for attaching to a belt, shirt pocket or trouser pocket



Code	No.	Luminous flux	Luminous duration h	Length mm	Width mm	Height mm	Weight kg
3301758	R95300139	130	up to 4	139	15	15	0,056

**R9570 0089**  
MINI WORK LAMP

**€22,60**  
+ VAT

- > Mobile companion for all applications
- > Extremely bright lamp in a small compact format
- > 2 Magnets provide different holding options in different work areas
- > Mobile companion for all applications
- > Practical clip for attaching to a belt, shirt pocket or trouser pocket



Code	No.	Luminous flux	Luminous duration h	Length mm	Width mm	Height mm	Weight kg
3301759	R95700089	300	up to 3	89	21	12	0,035

**R9560 0320**  
**INSPECTION LAMP**

- > Ideal as a work lamp for mobile use in various areas
- > 5 switching functions for adjustable brightness
- > Magnet and 180° rotatable hook provide different holding options
- > Enables flexible and mobile use, as well as hands-free work

**€36,13**  
+ VAT



Code	No.	Luminous flux	Luminous duration h	Length mm	Width mm	Height mm	Weight kg
3301760	R95600320	500	up to 12	320	33	43	0,26

**R9540 0145**  
**SPOTLIGHT**

- > Compact, portable spotlight
- > Ideal for working in places without power supply
- > Shockproof and splash-proof rubberized border
- > 180° rotatable stand

**€29,82**  
+ VAT

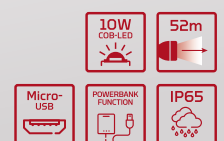

Code	No.	Luminous flux	Luminous duration h	Width mm	Height mm	Depth mm	Weight kg
3301761	R95400145	1.400	up to 6	145	145	40	0,643

**NEW**

# 2 IN 1: THE MINI WORKING LAMP WITH UV LIGHT

Lightweight with 7 h light output and 3 switching functions.

The magnetic GEDORE red **mini working lamp UV R95200111** – ideal for car work, workshops, cellars or everywhere handy light is required. The compact lamp fits into all trouser pockets and can also be fixed with a clip or magnets for handsfree working. The highlight: The integrated UV light provides even more efficiency – and not just in the automotive area. With just 3 h charging time for a full 7 h of lighting time, it's an absolute must-have for all trades.

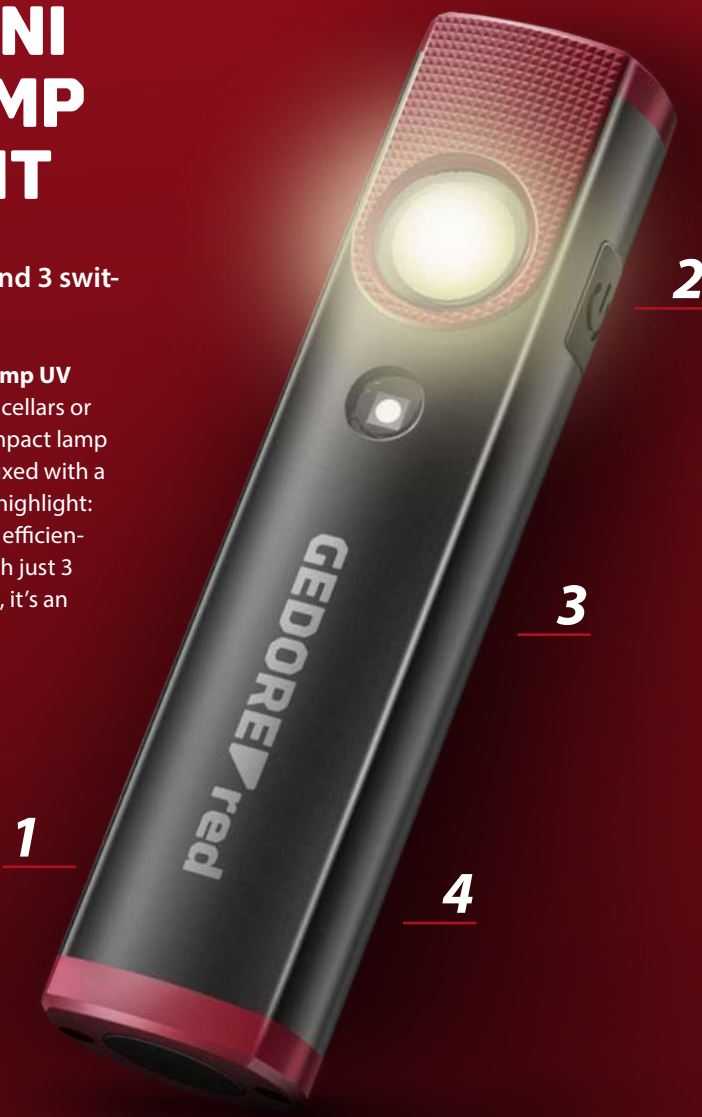

Mini working lamp UV – R95200111

**1** COMPACT SIZE WITH HIGH LIGHT OUTPUT

**2** 7 H LIGHT OUTPUT

**3** FIXING WITH MAGNET OR CLIP

**4** 2 IN 1: WHITE AND UV LIGHT

**LIGHTING POWERHOUSE - WITH UV LIGHT**



**NEW**

**R9520 0111**  
**MINI WORK LAMP UV**

- > 2-in-1: for applications with white and UV light
- > UV light, ideal for automotive use
- > Compact dimensions save space and weight
- > Two magnets ensure variable mounting options
- > Practical clip for attaching to a belt, shirt or trousers
- > Charging time: 3 h; lighting time: up to 7 h



**€ 23,52**  
+ VAT

Code	No.	Luminous flux	Luminous duration h	Length mm	Width mm	Height mm	Weight kg
3301763	R95200111	340	up to 7	111,4	32,7	27,6	0,104

# FLEXIBLE HEADLAMP WITH SENSOR CONTROL

**NEW**

**Individual, tiltable field of vision lighting for full view.**

The GEDORE red headlamp R95500058 – up to 260 lm luminosity in direct field of vision. The ideal companion for handsfree working in the workshop, construction site, garage, in the home and everywhere else. With 4 different

light settings (50-260 lm) for focussed or widely-diffused light, the headlamp can be individually set according to the light required. The gesture control enables contactless switching on and off with a gesture of the hand. The elastic headband flexibly fits every head size. Strong light for up to 9 h.



Headlamp 260 – R95500058

- 1** 4 LIGHT LEVELS
- 2** CONTACTLESS SWITCHING ON AND OFF
- 3** ELASTIC HEADBAND
- 4** SHORT CHARGING TIME, LONG LIGHTING TIME



**R9550 0058**  
**HEADLAMP**  
**260**

- > 4 light levels (50-260 lm)
- > Sturdy ABS housing
- > Charging time: 4 h; lighting time: up to 9 h
- > Gesture control for contactless switching on & off
- > Elastic headband, individually adjustable, easy take-off



**€25,<sup>20</sup>**  
+ VAT



Code	No.	Luminous flux	Luminous duration h	Width mm	Height mm	Depth mm	Weight kg
3301762	R95500058	260	up to 9	58	44	37	0,052

**R9380 0125**  
**PARALLEL VICE**  
 rigid

- > With anvil
- > Max. clamping force 25 KN

**€141,18**  
 + VAT



Code	No.	Jaw width mm	Clamping depth usable mm	Weight kg
3301737	R93800125	125	125	19

**R9380 0150**  
**PARALLEL VICE**  
 swiveling

- > Chuck for pipes with 13.5 - 56 mm diameter
- > With anvil
- > Max. clamping force 25 KN

**€156,30**  
 + VAT



Code	No.	Jaw width mm	Clamping depth usable mm	Weight kg
3301738	R93800150	150	125	14



## R9410 XXXX SPIRIT LEVEL

- > Smooth square alloy profile
- > One vertical and one horizontal vial
- > Measurement accuracy: +/- 0.5 mm/m

from

€10,<sup>66</sup>  
+ VAT



Code	No.	Length mm	Weight kg	excl. VAT
3301422	R94100051	300	0,17	10,66
3301423	R94100087	1.000	0,48	21,25

## R9410 XXXX SPIRIT LEVEL with a movable vial, magnetic

- > Smooth square alloy profile
- > One vertical and one horizontal vial
- > Measurement accuracy: +/- 0.5 mm/m
- > Magnetic

from

€13,<sup>27</sup>  
+ VAT



Code	No.	Length mm	Weight kg	excl. VAT
3301424	R94100151	300	0,17	13,27
3301425	R94100187	1.000	0,482	23,35

## R9455 XXXX TAPE MEASURE

- > Housing from 2-component ABS, fitted out with metal clip
- > Automatic tape rewind and lock
- > With magnetic stop
- > Accuracy class II with MID certificate

from

€6,<sup>29</sup>  
+ VAT



Code	No.	Length m	Tape width mm	Weight kg	excl. VAT
3301427	R94550003	3	19	0,201	6,29
3301428	R94550005	5	19	0,265	9,49
3301429	R94550008	8	25	0,468	10,83

**R9320 0025**  
UTILITY KNIFE

**€10,92**  
+ VAT



- > With practical belt clip
- > Blade 25 mm wide
- > Supplied with 5 spare blades (125mm long, 0.5mm thick)



Code	No.	Total length mm
3301605	R93200025	205

Total width mm
60

Weight kg
0,28

**R9322 0028**  
VDE CABLE KNIFE

**€14,28**  
+ VAT



- > VDE-insulated acc. to DIN EN 60900
- > Straight cutting edge
- > With protective cap



Code	No.	Blade length mm
3301415	R93220028	45

Total length mm
185

Weight kg
0,143

**R9980 0000**  
MULTIFUNCTION  
TOOL



- > Stainless steel
- > Blade locking feature
- > Ergonomic handle, gentle power transmission

**€21,92**  
+ VAT

Code	No.
3301757	R99800000

Weight kg
0,21

**R9335 0051**  
MULTIFUNCTION  
SAW



**€22,76**  
+ VAT

- > Bracket 180° rotatable
- > Supplied with HSS bi-metal saw blade (24 tpi)
- > For metal, plastic, wood, etc.



Code	No.	Length mm
3301608	R93350051	300

Weight kg
0,47

**R9300 0005**  
**FILE KIT**  
 5 pieces



- > File set in the most common versions
- > 2-component-handle, for easy comfortable use

**€28,48**  
 + VAT

Code	No.	Contents	Length mm	Pieces	Weight kg
3301597	R93000005	Triangular file Flat file Round file Half-round file Square file	310	5	0,82

**R9340 0060**  
**SCRAPER**



- > For minor improvements/repair
- > Apply, spread and smooth down

**€6,71**  
 + VAT

Code	No.	Blade width mm	Weight kg
3301754	R93400060	60,0	0,1

**R9921 0000**  
**CARTRIDGE CAULKING GUN**



- > Quick and easy cartridge change
- > Supplied with 3 tips

**€35,20**  
 + VAT

Code	No.	Length mm	Height mm	Weight kg
3301753	R99210000	340	210	0,84

# GEDORE

TOOLS FOR LIFE

## **GEDORE Werkzeugfabrik GmbH & Co. KG**

Remscheider Straße 149  
42899 Remscheid · GERMANY  
Tel. + 49 (0) 21 91- 596 - 0  
Fax + 49 (0) 21 91- 596 - 230  
info@gedore.com  
www.gedore.com

Vertrieb Deutschland  
Tel. + 49 (0) 21 91- 596 - 900  
Fax + 49 (0) 21 91- 596 - 999

## **GEDORE Automotive GmbH**

Breslauer Straße 41  
78166 Donaueschingen · GERMANY  
Tel. +49 771 83223-0  
Fax +49 771 83223-90  
info.gam@gedore.com  
www.gedore-automotive.com

## **GEDORE Torque Solutions GmbH**

Bertha-Benz-Straße 12  
71665 Vaihingen/Enz · GERMANY  
T +49 7042 9441-0  
F +49 7042 9441-41  
torque-solutions@gedore.com

## **GEDORE AUSTRIA GmbH**

Gedore-Str. 1  
8190 Birkfeld / Stmk. · AUSTRIA  
Tel. +43 (0) 3174 / 363 64 00  
Fax +43 (0) 3174 / 363 83 20  
sales.austria@gedore.com  
www.gedore.at

## **GEDORE Tools S.A. (Pty) Ltd.**

103 Qashana Khuzwayo (Shepstone) Road,  
New Germany, 3610 - South Africa  
PO Box 68, New Germany, 3620  
SOUTH AFRICA  
Tel. +27 (0) 31 / 705 3587  
Fax +27 (0) 31 / 705 32770  
esales@gedore.co.za  
www.gedore.co.za

## **GEDORE IBÉRICA S.L.**

c/Arangutxi 12, Poligono Industrial de Júndiz  
01015 Vitoria Alava · SPAIN  
Tel. +34-945-29 22 62  
Fax +34-945-29 21 99  
gedore@gedore.es  
www.gedore.es

## **GEDORE Torque Ltd**

(Formerly Gedore UK)  
Tannery Lane, Gosden Common  
Bramley, Guildford  
Surrey  
GU5 0AJ · UNITED KINGDOM  
Tel. +44 (0) 1756 / 70 67 00  
sales@gedoreuk.com  
www.gedoreuk.com

## **GEDORE France SARL**

Parc d'activités des Béthunes - La Mare II  
10, avenue du Fief - Bât. 12  
BP 79144 Saint-Ouen-l'Aumône  
F-95074 Cergy Pontoise Cedex · FRANCE  
Tél. +33 (0)1 34 40 16 60  
Fax +33 (0)1 34 40 16 61  
jadore@gedore.fr  
www.gedore.fr

## **GEDORE TECHNAG B.V.**

Flemingweg 7, 2408 AV  
Alphen aan den Rijn · NETHERLANDS  
Tel. +31 (0) 172 / 42 73 50  
Fax +31 (0) 172 / 42 73 60  
info@gedore.nl  
www.gedore.nl

## **GEDORE (INDIA) Private Limited**

148, Sector 3, IMT Manesar  
Gurgaon - 122051  
Haryana · INDIA  
Tel. +91 (0) 124 22910 - 65/66/67  
Fax +91 124 2341067  
sales@gedoreindia.com  
www.gedore.in

## **GEDORE POLSKA Sp. z o.o.**

ul. Żwirki i Wigury 56a  
43-190 Mikołów · POLAND  
Tel. +48 (0) 32 / 738-40 10  
Fax +48 (0) 32 / 738-40 20  
gedore@gedore.pl  
www.gedore.pl

## **Ferramentas GEDORE do Brasil S.A.**

Rua Vicentina Maria Fidélis,  
275 Bairro Vicentina  
São Leopoldo - RS | 93025-340 · BRAZIL  
Tel. +55 51- 3589 9200  
Fax + 55 51- 3589 9222  
export@gedore.com.br  
www.gedore.com.br

## **GEDORE TOOLS INC**

4055 Faber Pl Dr  
North Charleston SC, 29405 · USA  
Phone: +1 (843) 225 5015  
Fax: +1 (843) 300 0315  
info@gedoretools.com  
www.gedoretools.com

## **GEDORE Tool Trading (Shanghai) Co., Ltd.**

1/F., Block 2, 1358 Pingan Road,  
Minhang, Shanghai · CHINA 201109  
Tel. +86-21-3388 7258  
Fax +86-21-3388 7259  
Service Hotline: 400 880 1858  
info@gedore.cn  
www.gedore.cn

Your dealer / stamp:

**Brands of the GEDORE Group**  
gedore.com · ochsenkopf.com

**IMPULSE TOOL PROMOTION** valid  
from 01/03/2024 until 31/12/2024.  
While stocks last.

\*Special net prices per pc./set, plus VAT Delivery without decoration.  
Technical specifications subject to modifications. No liability for printing errors.  
Prices exclude VAT / for resellers only. Please ask your local dealer.

**gedore.com**