

* La dulapuri mobile si bancuri de lucru transportul se oferteaza separat

EN | VALID FROM 01/03/2024 - 31/12/2024

GEDORE

MAGIC 24

PREMIUM TOOLS / QUALITY MADE BY GEDORE



Tool trolley with Tool Assortment for Cars 2005 XL-5-466

€6250,00^{+VAT}



Torsions bit set 666-045

€31,89^{+VAT}



TORCOFIX SE/K 1-850 Nm

from

€143,70^{+VAT}

**406 TOOLS,
25 HIGHLIGHTS
AND INNOVATIONS**



WK
SHEET METAL
CASE WITH INLAY

36

1101-1.31/0-H
INTERNAL
EXTRACTOR
SET

114





2005 XL-5-466
TOOL TROLLEY
WITH TOOL
ASSORTMENT
FOR CARS

64



TF
TORCOFIX SE/K

30

148 OX 620 H-1257
UNIVERSAL FORESTRY AXE
ROT BAND-PLUS

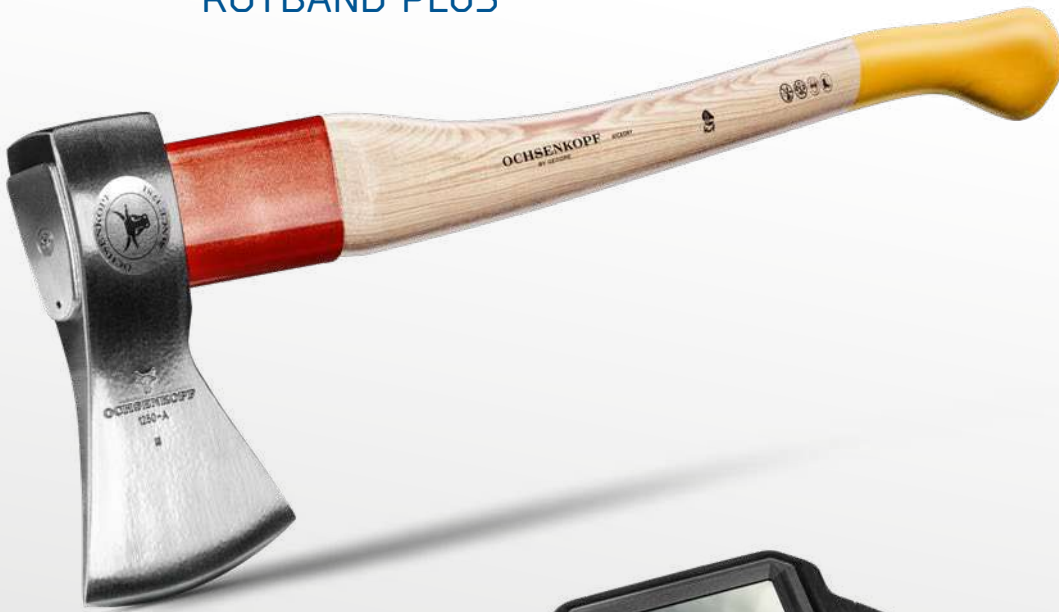

KL-0880-10 K
VIDEOSCOPE

142



666-045
TORSIONS
BIT SET



10



1100-1.31/2
INTERNAL
EXTRACTOR
SET

116

CONTENTS

	SPANNERS	04 – 09		MOBILE TOOL STORAGE	93 – 99
	SOCKETS AND ACCESSORIES	08 – 29		PULLERS	102 – 119
	TORQUE TOOLS	30 – 42		HAMMERS / STRIKING TOOLS	120 – 123
	SCREWDRIVERS	43 – 45		PLIERS	124 – 132
	WORKSHOP EQUIPMENT	46 – 71		WORKSHOP SUPPLIES	99 – 101
	TOOL ASSORTMENTS	50 – 68		VDE INSULATED SAFETY TOOLS	132 – 139
	AGRI	72 – 74		AUTOMOTIVE	140 – 145
	MODULE	75 – 92		OCHSENKOPF	146 – 151

5-PIECE COMBINATION RATCHET WRENCH SET, 8-19 MM

Reversible combination ratchet wrench set in the most popular used sizes.

The universally usable **5-piece combination ratchet wrench set 7 UR-005** from GEDORE, with 8, 10, 13, 17 and 19 mm sizes, is ideal for the most diverse screwing jobs. The low 5-7° reverse angle ensures efficient handling, and there's no changing when tightening or loosening. Thanks to the UD profile (Unit Drive profile) the screw power is transferred carefully to the screw, so even damaged screws can be gripped and loosened easily and problem-free. The flat design with 13° angled ring end is also ideal for confined working areas. Thanks to the slip-proof surface the wrench also meets the high work safety requirements in demanding work environments.

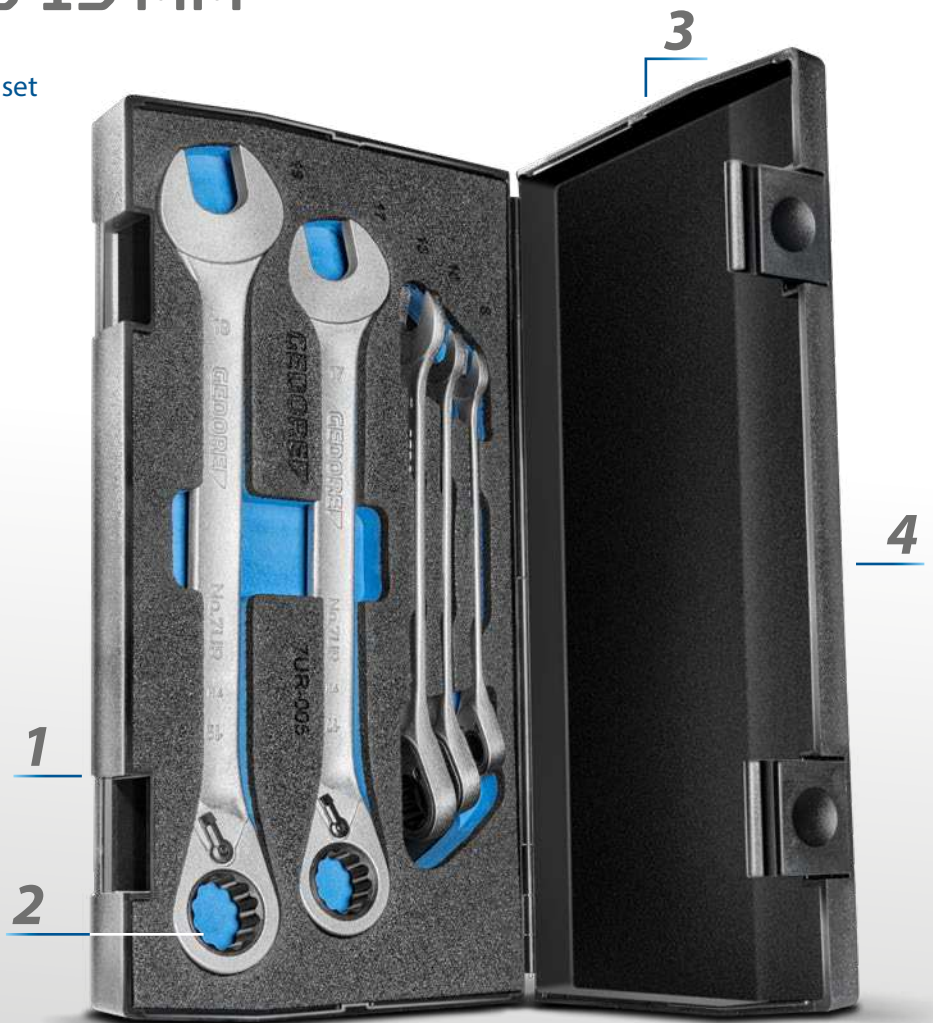

Combination ratchet wrench set, 5-piece – 7 UR-005

1

OPTIMISED 5-7° REVERSE ANGLE FOR EFFICIENT HANDLING

2

SCREW HEAD-FRIENDLY UD PROFILE

3

SAFE TO LOSE THANKS TO NON-SLIP SURFACE

4

FLAT DESIGN FOR CONFINED WORKING AREAS



MORE EFFICIENT SET

7 UR-005 COMBINATION RATCHET SPANNER SET, REVERSIBLE

5 pieces

- > In accordance with DIN 3113, ISO 3318
- > Ring offset to 15°, reversible for right and left hand operation
- > Ratchet mechanism with 72 teeth
- > In holder



€100,⁸⁴
+ VAT



Code	No.	Contents	Width mm	Height mm	Pieces	Weight kg
2327651	7 UR-005	7 UR 8 10 13 17 19	145	42	5	0,93

7 R-012 COMBINATION RATCHET SPANNER SET

12 pieces

- > Practical combination of open-end wrenches with ring ratchet and equal wrench sizes
- > High torque transmission enables efficient, ratcheting work



€194,¹²
+ VAT

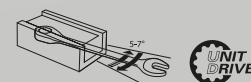

Code	No.	Contents	Length mm	Pieces	Weight kg
2297442	7 R-012	7 R 8 9 10 11 12 13 14 15 16 17 18 19	320	12	2,84

7 XL-012

COMBINATION SPANNER SET

extra long, 12 pieces



- > Extra long shaft for more torque
- > Slim jaw and jaw walls make this spanner lighter overall
- > Ring 15° angled, with UD profile - for gentle power transmission
- > Mouth position 15°, precisely ground to exact nominal dimension for optimum contact surfaces

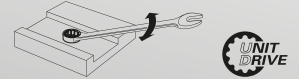

Code	No.	Contents
6095950	7 XL-012	10 11 12 13 14 17 19 22 24 27 30 32 mm

Pieces	Weight kg
12	4,41

6-120

DOUBLE OPEN ENDED SPANNER SET

12 pieces



- > With flat heads
- > Jaw: ground precisely to exact nominal size for optimum contact areas
- > Secure grip thanks to slim profile shaft
- > Overloading indicated by deformation

€90,67 + VAT

Code	No.	Contents
6077890	6-120	6x7 8x9 10x11 12x13 14x15 16x17 18x19 20x22 21x23 24x27 25x28 30x32

Pieces	Weight kg
12	2,52

2 ATM

SINGLE ENDED RING SPANNER SET

19 pieces

€1254,62 + VAT



- > Heavy-duty pattern for highest torques
- > With push-on tubes No. 2 AR to extend the lever arm
- > With UD profile for gentle power transmission; from 65mm bi-hex
- > Includes sheet steel wall plate and hook set for organized storage

Code	No.	Contents
6049250	2 ATM	2 A 24 27 30 32 36 41 46 50 55 60 65 70 75 80 85 2 AR 0 1 2 3 Sheet steel board with hook set

Pieces	Weight kg
19	53

400 DOUBLE ENDED RING SPANNER

open

- › Sizes 8x10 to 12x14 mm with hexagon
- › Application on hydraulic/brake lines
- › Heads 15° angled
- › Hexagonal opening 30° offset, UD profile opening 15° offset

€16,²⁹
+ VAT

from



Code	No.	Width across flats mm	Length mm	Weight kg	€ excl. VAT
6057190	400 8X10	8x10	140	0,045	16,29
6057270	400 10X11	10x11	150	0,064	17,22
6057350	400 11X13	11x13	160	0,077	17,64
6057430	400 12X14	12x14	170	0,106	18,06
6057000	400 13X15	13x15	180	0,116	18,06
6057510	400 14X17	14x17	195	0,136	18,98
6057780	400 17X19	17x19	215	0,179	19,91
6058670	400 19X22	19x22	232	0,246	27,13
6057860	400 22X24	22x24	250	0,335	27,13
6058750	400 24X27	24x27	270	0,408	36,13
6058830	400 30X32	30x32	300	0,575	45,20
1933175	400 36X41	36x41	345	0,98	49,74

7 RA 183 RATCHET SPANNER SET

with plier wrench, 10
pieces

€157,⁹⁸
+ VAT



- › Practical set for through bolts. For countering and counter-holding with the same width across flats
- › Flat pliers wrench with 0 - 42 or 1.5/8" including jaws for surface-friendly gripping included in the set
- › With adapter (1/4", 1/2") for the use of sockets on the ring ratchet spanner

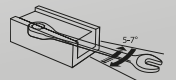

Code	No.	Contents	Width mm	Height mm	Depth mm	Pieces	Weight kg
3416356	7 RA 183	7 R Open-end spanner with ring ratchet 8 10 13 17 19 mm 7 RA-12,5 Adapter 1/2" 19 mm, 7 RA-6,3 Adapter 1/4" 10 mm 183 7 TC Pliers spanner incl. jaws WK 19DM/IN19 L Box empty, EI-7 RA 183 Foam insert empty	360	70	120	10	1,7

666-006 BIT BOX SOCKET MACHINE MOUNT

6 pieces

€29,⁸²
+ VAT



- › Socket wrench inserts with magnet for damage-free insertion and removal of hexagon head screws
- › Especially suitable for self-drilling screws



Code	No.	Contents	Width mm	Height mm	Depth mm	Pieces	Weight kg
2993244	666-006	Socket machine mount 1/4" 7 8 10 12 13 mm and 3/8"	143	42		6	0,24

NEW

45-PIECE TORSION BIT SET - LOW-WEAR SCREWS

Torsion bit set with torsion zone to protect bits under load.

The **45-piece torsion bit set 666-045** from GEDORE is simply perfect for timber screw connections and assembly work in timber and metal construction. With the 45 pieces you have the most commonly used bit profile sizes in several designs in just one case. The bits' integrated torsion zone protects the bit profile from wear and tear and at the same time also protects the screw connection. This massively increases the bits' service life. To ensure a clear overview there is also colour coding for the individual drives, which then helps when looking for the right drive. A 1/4" square adapter is included for extra flexibility. Additional wrench sizes can then be screwed with this adapter.



45-piece torsion bit set – 666-045

1

EXTENSIVE ASSORTMENT WITH 45 PIECES

2

TORSION ZONE PROTECTS BITS FROM WEAR AND TEAR

3

COLOUR CODING FOR EASIER PROFILE IDENTIFICATION

4

1/4" ADAPTER FOR EVEN MORE FLEXIBILITY

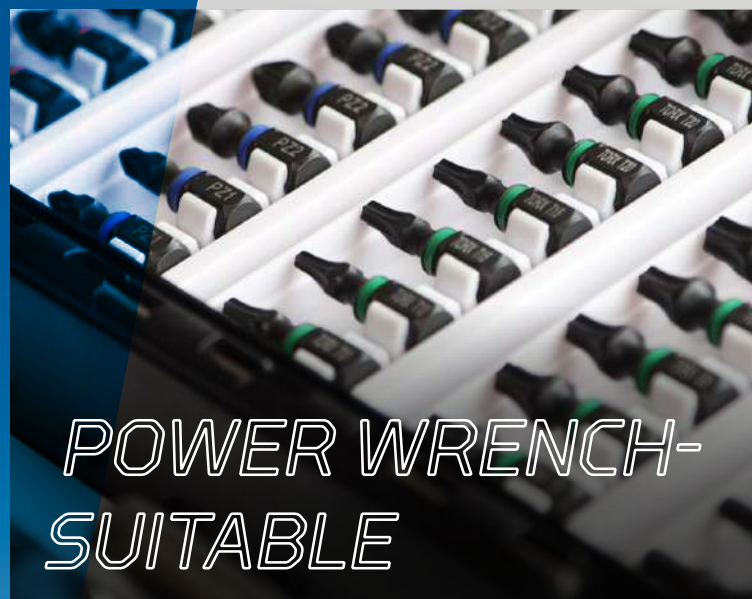

POWER WRENCH-SUITABLE

666-045
TORSIONS BIT SET

45 pieces



- > Extensive assortment with the most common bit profile sizes
- > Bits with torsion zone to protect the bit profile from wear and tear
- > Color coding simplifies profile identification and assignment
- > 1/4" square adapter for more flexibility

€31,89
+ VAT

Code	No.	Contents	Width mm	Height mm	Depth mm	Pieces	Weight kg
3459519	666-045	1/4" Screwdriver bits PH 1 1 2 2 2 2 3 3 1/4" Screwdriver bits PZ 1 1 2 2 2 2 3 3 1/4" TX T10 T15 T15 T20 T20 T20 T20 T25 T25 T25 T30 T30 T40 T40 1/4 Internal hex 3 3 4 4 5 5 6 8 mm Socket, magnetic, with 1/4" hexagon drive 8mm, L.67mm Socket, magnetic, with 1/4" hexagon drive 10mm, L.67mm Socket, magnetic, with 1/4" hexagon drive 13mm, L.67mm Drive adapter 1/4" hexagon x 1/4" square, L. 50mm 1/4" Bit-Adapter with safety device	190	45	120	45	0,57

666-032-A
BIT-BOX ALLROUND

32 pieces

€18,06
+ VAT

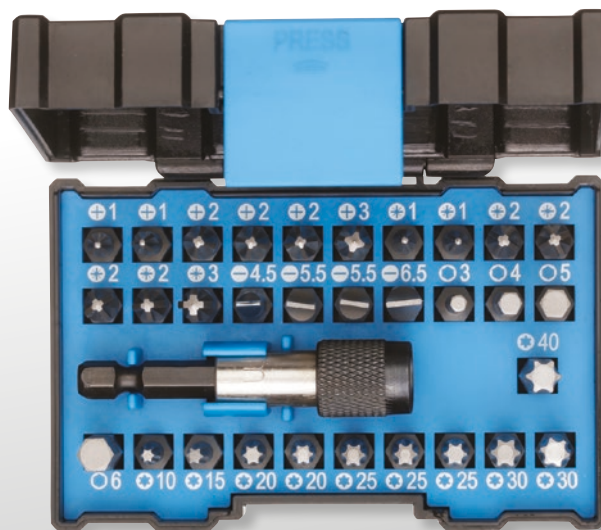

- > For industry, the tradesmen and DIY
- > 1/4" bit holder with quick-grip system

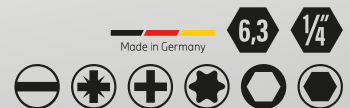

Code	No.	Contents	Pieces	Weight kg
2993236	666-032-A	4,5 (1x) 5,5 (2x) 6,5 (1x) PH 1 (2x) PH 2 (3x) PH 3 (1x) PZ 1 (2x) PZ 2 (4x) PZ 3 (1x) TX T10 (1x) T15 (1x) T20 (2x) T25 (3x) T30 (2x) T40 (1x) 3 (1x) 4 (1x) 5 (1x) 6 (1x) Adapter 1/4"-1/4"	32	0,246

666-042
TORSIONS
BIT SET
 42 pieces

€36,¹³
 + VAT

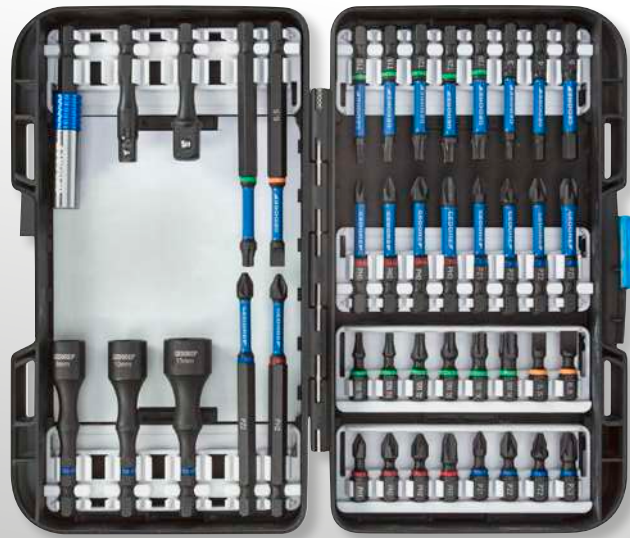

- > Torsion zone to protect bits under load. Peak torques are gently cushioned, which increases the lifetime
- > Incl. extremely slim, self-locking magnetic bit holder with quick change function
- > Suitable for use in Impact sockets



Code	No.	Contents	Width mm	Height mm	Depth mm	Pieces	Weight kg
3100316	666-042	1/4" Bits, 25mm: 1/4" slotted 5,5, 6,5 mm, 1/4" PH 1 2 2 3 1/4" PH 1 2 2 3, 1/4" PZ 1 2 2 3, 1/4" TX T10 T15 T20 T25 T30 T40 1/4" Bits, 50mm: 1/4" hexagon 3 4 5 mm, 1/4" PH 1 2 2 3, 1/4" PZ 1 2 2 3, 1/4" TX T10 T15 T20 T25 T30 1/4" Bits, 88.9mm: 1/4" slotted 5,5 mm, 1/4" PH 2, 1/4" PZ 2, 1/4" TX T25 Drive adapter 1/4" hexagonal x 1/4" square, L. 50mm Drive adapter 1/4" hexagonal x 3/8" square, L. 50mm Socket, magnetic, with 1/4" hex drive 8mm, L.67mm Socket, magnetic, with 1/4" hex drive 10mm, L.67mm Socket wrench insert, magnetic, with 1/4" hex drive 13mm, L.67mm Bit-Holder 1/4, One-touch Slim Lock, L.66,5mm	190	45	120	42	0,67

670
1/4" BIT SCREWDRIVER

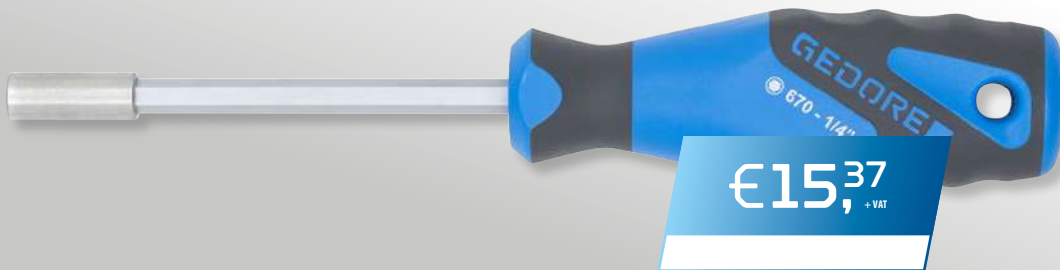

€15,³⁷
 + VAT

- > With hexagon drive as per DIN ISO 1173 for Bits
- > With strong magnetic holder



Code	No.	Drive connector hexagon female	Drive connector hexagon female mm	Blade length mm	Total length mm	Weight kg
6536590	670	1/4"	6,3	100	210	0,14

671
1/4" BIT RATCHET

€49,⁷⁴
 + VAT



- > With knurled head for quick starting or counter-holding of screws
- > Hexagon socket according to DIN ISO 1173
- > Slim line design for working in confined spaces



Code	No.	Drive connector hexagon female	Drive connector hexagon female mm	Return angle	Total length mm	Head height mm	Weight kg
6535350	671	1/4"	6,3	15°	127	18,3	0,108

2093 U-20 1/4" REVERSIBLE RATCHET



€36,¹³
+ VAT

- › For hand-operated sockets and accessories with square drive as per DIN 3120 - C 6.3, ISO 1174, ball locking device
- › Universal use in industry and automotive, even in confined spaces
- › Small, drop shaped head for confined spaces
- › Fine-toothed (40 teeth), with lever change and push-button release



Code	No.	Square drive inch	Square drive mm	Return angle	Length mm	Ratchet head height mm	Number of teeth	Weight kg
1703749	2093 U-20	1/4"	6,3	9°	130	20	40	0,095

2093 U-3 T 1/4" RATCHET WITH T-HANDLE



€27,¹³
+ VAT

- › Especially suitable for work in confined spaces
- › For hand-operated sockets and accessories with square drive as per DIN 3120 - C 6.3, ISO 1174, ball locking device
- › Switchable with easy-grip metal switch disc



Code	No.	Drive connector square	Drive connector square mm	Return angle	Total length mm	Weight kg
1791532	2093 U-3 T	1/4"	6,3	5°	141	0,065

3093 U-20 3/8" REVERSIBLE RATCHET



€47,⁸⁹
+ VAT

- › For hand-operated sockets and accessories with square drive as per DIN 3120 - C 10, ISO 1174, ball locking device
- › Universal use in industry and automotive, even in confined spaces
- › Small, drop shaped head for confined spaces
- › Fine-toothed (60 teeth), with lever change and push-button release



Code	No.	Square drive inch	Square drive mm	Return angle	Length mm	Ratchet head height mm	Number of teeth	Weight kg
1556800	3093 U-20	3/8"	10	6°	200	29,7	60	0,292

3093 U-3 3/8" REVERSIBLE RATCHET



- > For hand-operated sockets and accessories with square drive as per DIN 3120 - C 10, ISO 1174, ball locking device
- > Perfect for work in confined spaces
- > Acc. to DIN 3122, ISO 3315
- > With non-slip metal disc change, fine-toothed (72 teeth) and robust

10 **3/8"**

Code	No.	Square drive inch	Square drive mm	Return angle	Length mm	Ratchet head height mm	Number of teeth	Weight kg
6237090	3093 U-3	3/8"	10	5°	200	33,5	72	0,244

1993 U-20 1/2" REVERSIBLE RATCHET



- > For hand-operated sockets and accessories with square drive as per DIN 3120 - C 12.5, ISO 1174, ball locking device
- > Acc. to DIN 3122, ISO 3315
- > Small, drop shaped head for confined spaces



Code	No.	Square drive inch	Square drive mm	Return angle	Length mm	Ratchet head height mm	Number of teeth	Weight kg
1436686	1993 U-20	1/2"	12,5	6°	275	37,5	60	0,536

1993 U-20 SK 1/2" REVERSIBLE RATCHET



- > For hand-operated sockets with hexagon No. 19 SK
- > Especially suitable for threaded bolts and difficult to access spaces
- > With hexagon drive
- > Torques according to DIN 3122 are exceeded
- > Fine-toothed (60 teeth), with lever change

Code	No.	Return angle	Length mm	Ratchet head height mm	Number of teeth	Weight kg
2219492	1993 U-20 SK	6°	275	21	60	0,51

1993 U-20 G 1/2" REVERSIBLE RATCHET with offset handle



- > For hand-operated sockets and accessories with square drive as per DIN 3120 - C 12.5, ISO 1174, ball locking device
- > Acc. to DIN 3122, ISO 3315
- > Fine-toothed (60 teeth), with lever change and push-button release



Code	No.	Drive connector square	Drive connector square mm	Return angle	Total length mm	Ratchet head height mm	Number of teeth	Weight kg
2746786	1993 U-20 G	1/2"	12,5	6°	270	37,5	60	0,54

1993 ALU-10
1/2" ALUMINIUM REVERSIBLE RATCHET
 extra light



- > For hand-operated sockets and accessories with square drive as per DIN 3120 - C 12.5, ISO 1174, ball locking device
- > Particularly light for ergonomic and force-saving work
- > Design similar to DIN 3122, ISO 3315
- > With recessed lever change
- > Locks in the middle position: When the lever is flipped, it automatically engages for clockwise or anti-clockwise operation



Code	No.	Square drive inch	Square drive mm	Return angle	Length mm	Ratchet head height mm	Number of teeth	Weight kg
6142700	1993 ALU-10	1/2"	12,5	7,5°	275	39	48	0,34

1993 TU-10
1/2" TELESCOPIC REVERSIBLE RATCHET



- > Long lever arm for high torques, max. torque 600 Nm
- > With push-button release
- > For hand-operated sockets and accessories with square drive as per DIN 3120 - C 12.5, ISO 1174, ball locking device



Code	No.	Square drive inch	Square drive mm	variable length	Return angle	Number of teeth	Weight kg
3041859	1993 TU-10	1/2"	12,5	400-600	7,5°	48	1,31

3293 U-2
3/4" REVERSIBLE RATCHET



- > For hand-operated sockets and accessories with square drive as per DIN 3120 - D 20, ISO 1174 with locking pin
- > With disc change, fine-toothed and robust



Code	No.	Drive connector square	Drive connector square mm	Return angle	Total length mm	Ratchet head height	Number of teeth	Weight kg
6278600	3293 U-2	3/4"	20	7,2°	500	60	50	1,435

19 DMU 183
SOCKET SET
 with pliers spanner,
 18 pieces

€239,⁵⁰
 + VAT



- > 1/2" ratchet set with wobble extension and pliers wrench size 7 (0-42mm / 0-1.5/8")
- > Proven 1993 U-20 ratchet and inserts with hexagonal UD profile (10-32 mm)
- > Incl. protective jaws for pliers wrench for easy grip
- > Checktool insert in compact plastic case with viewing window



Code	No.	Contents	Width mm	Height mm	Depth mm	Pieces	Weight kg
3416321	19 DMU 183	19 Socket 10 12 13 15 16 17 18 19 22 24 27 30 32 1990 KR-5 wobble Extension 1/2" 1993 U-20 Reversible ratchet 1/2" 183 7 TC Pliers wrench including protective jaws WK 19DM/IN19 L Box empty EI-19 DMU 183 Foam insert empty	360	70	190	18	3,1

19 SKU-20
1/2" SOCKET SET
 14 pieces



€225,²¹
 + VAT

- > Sockets No. 19 SK for threaded and bolted connections
- > Robust lever-operated ratchet with hexagon socket drive, low overall height
- > Fine toothed, return angle 6°

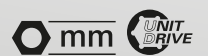

Code	No.	Contents	Width mm	Height mm	Depth mm	Pieces	Weight kg
2521563	19 SKU-20	Ratchet 1993 U-20 SK Inserts 19 SK 10 11 12 13 14 15 16 17 18 19 21 22 24	320	55	132	14	1,7

FOR THE TIGHTEST SPACES

C19 1/2" SOCKETS

C profile

from

€5,71
+ VAT

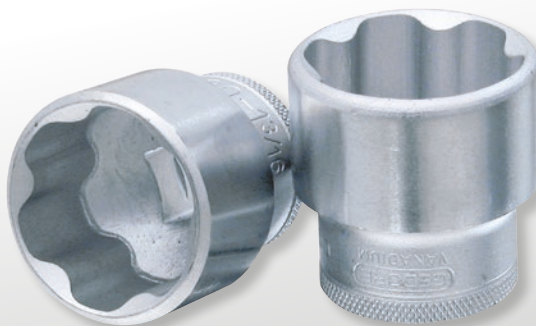

- › Hand-operated sockets for metric and imperial screw connections
- › In accordance with DIN 3124

1/2" 12,5

Code	No.	Width across flats mm	Width across flats inch	Length mm	Weight kg	excl. VAT
3103889	C19 10	10	3/8"	38	0,055	5,71
3103897	C19 12	12		38	0,055	5,87
3103900	C19 13	13	1/2"	38	0,057	6,04
3103919	C19 15	15	19/32"	40	0,065	6,46
3103927	C19 16	16	5/8"	40	0,065	6,55
3103935	C19 17	17		40	0,073	6,80
3103943	C19 18	18	11/16"	40	0,061	6,97
3103951	C19 19	19	3/4"	40	0,078	7,05
3103978	C19 22	22		41,5	0,099	8,06
3103986	C19 24	24	15/16"	41,5	0,124	8,14
3103994	C19 27	27	1.1/16"	41,5	0,145	10,41
3104001	C19 30	30	1.3/16"	43	0,175	11,17
3104028	C19 32	32	1.1/4"	43	0,189	11,34

1990 KR-10 1/2" UNIVERSAL EXTENSION



€18,06
+ VAT

- › With ball end
- › For hand-operated sockets and accessories with square drive as per DIN 3120, ISO 1174, ball locking device
- › The extension is able to pivot up to 18°
- › Load capacity max. 230 Nm

12,5 1/2"

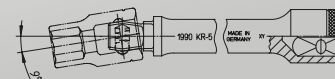

Code	No.	Drive square inch	Drive square metric	Length mm	Weight kg
6366570	1990 KR-10	1/2"	12,5	250	0,345

19 BMC 20
1/4"+1/2" SOCKET SET
 69 pieces



- › Basic set in 1/4" and 1/2" range
- › The reversible ratchets features a dual material handle, lever change and press-button release for easy, rapid and safe working
- › Depending on the wrench size, the sockets can be extended up to 375 mm in the drive depth
- › Incl. practical check tool insert

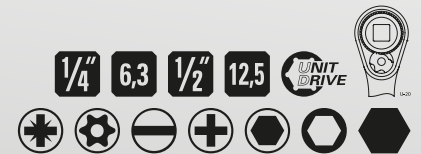

Code	No.	Contents	Width mm	Height mm	Depth mm	Pieces	Weight kg
3108902	19 BMC 20	1/4" + 1/2" Ratchets 1/4" 2093 U-20 Reversible ratchet 1/2" 1993 U-20 Reversible ratchet 1/4" + 1/2" Sockets 1/4" Hexagonal sockets 4 4,5 5,5 6 7 8 9 10 11 12 13 14 mm 1/2" Hexagonal sockets 15 16 17 18 19 21 22 24 27 30 32 mm 1/2" Hexagonal sockets long 10 13 17 19 mm 1/4" Bits Hexagon socket 2 3 4 5 6 8 mm TX; with bore T10 T15 T20 T25 T27 T30 T40 Slotted 4 5.5 6.5 8 mm, PH 1 2 3, PZ 1 2 3 Multi-tooth XZN M4 M5 M6 M8 1/4" + 1/2" Accessories 1/4" Extension 50 100 mm Adaptor 1/4" x 1/4" Bit-Holder 1/4", T-handle 1/4" Universal joint 1/4", Extension 1/2" 125 250 mm Universal joint 1/2" T-Handle 1/2"	460	86	355	69	5,7

S 2032-05
1/4" - 3/4" ADAPTOR SET
 5 pieces



- › With reducer and adaptor pieces from 1/4" to 3/4"
- › Please note the maximum load capacities of the outer square edge according to DIN 3123, ISO 3316



Code	No.	Contents	Length mm	Width mm	Height mm	Pieces	Weight kg
1729071	S 2032-05	2030 1/4" - 3/8" Adaptor (max. 62 Nm) 3019 3/8" - 1/2" Adaptor (max. 202 Nm) 1932 1/2" - 3/4" Adaptor (max. 512 Nm) 3020 3/8" - 1/4" Reducer (max. 62 Nm) 1930 1/2" - 3/8" Reducer (max. 202 Nm)	134	51	51	5	0,34

XX90 M
3/8" EXTENSION
with holding magnet

from €21,67 + VAT

- › For hand-operated sockets with through hole and square drive according to DIN 3120, ISO 1174, with ball locking device
- › The spring-loaded holding magnet fixes the screws or nuts in the socket so that they cannot be lost
- › The magnetic field of the holding magnet holds screws and nuts centrally in the socket without direct contact

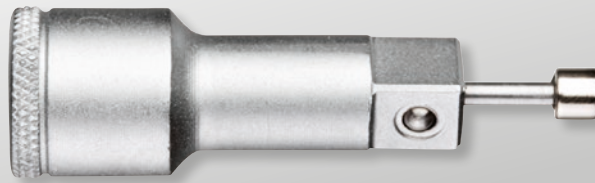
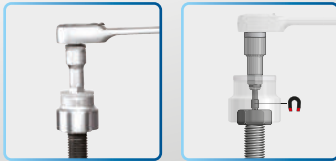

10 3/8" ⚡

Code	No.	Drive square inch	Drive square metric	Length mm	Weight kg	excl. VAT.
2697920	1990 M	1/2"	12,5	81,5	0,11	22,60
2960060	3090 M	3/8"	10	65	0,065	21,67

IN 19-009
1/2" SCREWDRIVER
SET
9 pieces

€90,67 + VAT

- › Screwdriver set 1/2" for hexagon socket screws in sizes 4 - 14 mm



12,5 1/2"

Code	No.	Contents	Width mm	Height mm	Depth mm	Pieces	Weight kg
3014444	IN 19-009	IN 19 4, IN 19 L 5-90 6-90 7-140 8-140 9-140 10-140 12-140 14-140	360	70	190	9	1,9

D 20 KMU-20
1/4" SOCKET SET
37 pieces

- › With forged, hardened and tempered, hand-operated bi-hex UD profile sockets
- › With robust lever-change reversible ratchet, with push-button release



€116,81 + VAT

6,3 1/4" 6,3 1/4" mm

Code	No.	Contents	Width mm	Height mm	Depth mm	Pieces	Weight kg
1822373	D 20 KMU-20	Ratchet 2093 U-20 Inserts D 20 4 5 6 7 8 9 10 11 12 13, 680 4 5,5 6,5, 685 3 4 5 6, 685 X 5 6 8 687 TX T10 T15 T20 T25 T27 T30 T40, 690 1 2, 690 PZD 1 2 3 Accessories 1/4" Extension 2090-4, 620, 1/4" Multi handle 676, 699	202	38	119	37	0,712

D 20 MOT
**1/4" BASIC TOOL SET FOR
 MOTORBIKES**
 30 pieces



€116,81
 + VAT

6,3 1/4" 6,3 1/4"  mm

- > Selected tools with metric dimensions for „first aid“ on motorbikes
- > T-handle reversible ratchet and wobble extension for hard-to-reach places
- > Incl. sockets and bits for a wide range of applications

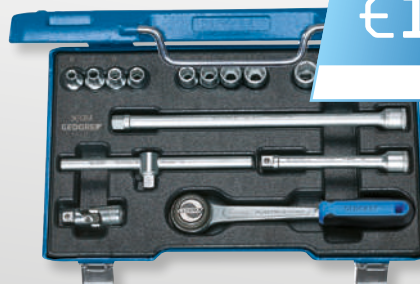

Code	No.	Contents	Width mm	Height mm	Depth mm	Pieces	Weight kg
2190281	D 20 MOT	Ratchet 2093 U-3 T Inserts D 20 8 9 10 11 12 13 14 685 3 4 5 6 8 10, 687 TX T10 T15 T20 T25 T27 T30 T40 690 1 2 3, 680 4 6, 5 Accessories 1/4" Extension KR-4, 1/4" Extension 2090-6 Universal joint 2095, 620	123	38	95	30	0,572

30 GMU
3/8" SOCKET SET
 17 pieces



from
€197,48
 + VAT

- > 3/8" sockets with hexagonal UD profile (No. 30)
- > U-3 with fine toothed , dial change ratchet
- > U-10 with reversible lever change ratchet

 mm
10 3/8" 

Code	No.	Contents	Width mm	Height mm	Depth mm	Pieces	Weight kg	excl. VAT.
6235710	30 GMU-10	Ratchet 3093 U-10 Inserts 30 6 7 8 9 10 11 13 14 15 16 17 19 Accessories 3/8" Sliding T-Handle 3087 3/8" Extension 3090-5-10 3/8" Universal joint 3095	320	55	210	17	2,6	197,48
6235980	30 GMU-3	Ratchet 3093 U-3 Inserts 30 6 7 8 9 10 11 13 14 15 16 17 19 Accessories 3/8" Sliding T-Handle 3087 3/8" Extension 3090-5-10 3/8" Universal joint 3095	320	55	210	17	2,6	198,32

19 DMU-20
1/2" SOCKET SET
 15 pieces



- › With hand-operated hexagonal UD profile sockets
- › With robust lever-change reversible ratchet, with push-button release
- › With wobble extension, is able to pivot up to 15°

€171,43
 + VAT



Code	No.	Contents	Width mm	Height mm	Depth mm	Pieces	Weight kg
3014347	19 DMU-20	Ratchet 1993 U-20 Inserts 19 10 12 13 15 16 17 18 19 22 24 27 30 32 Accessories 1/2" Extension 1990 KR-10	360	70	190	15	2,899

19 JMU-3
1/2" SOCKET SET
 19 pieces

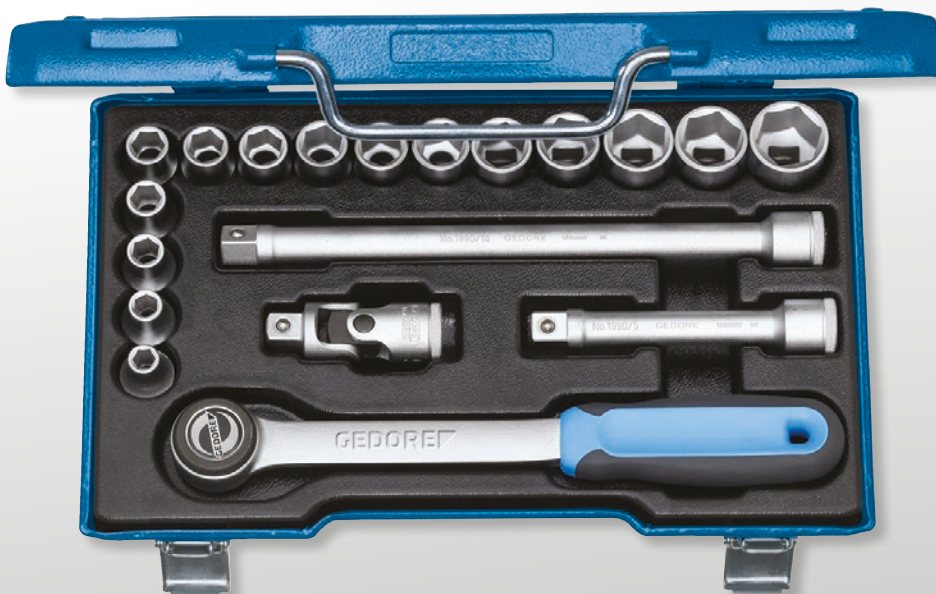

- › With hand-operated hexagonal UD profile sockets
- › With extra fine toothed reversible ratchet, reverse angle 5°

€206,72
 + VAT



Code	No.	Contents	Width mm	Height mm	Depth mm	Pieces	Weight kg
2682842	19 JMU-3	Ratchet 1993 U-3 Inserts 19 8 9 10 11 12 13 14 15 16 17 18 19 21 22 24 Accessories 1/2" Extension 1990-5-10 Universal joint 1995	320	55	210	19	3,7

D 19 IMU-10
1/2" SOCKET SET
 27 pieces

- > With forged, hardened and tempered, hand-operated bi-hex UD profile (No. D 19) sockets
- > With robust lever-change reversible ratchet, with push-button release

€261,34
 + VAT



12,5 1/2" UNIT DRIVE mm

Code	No.	Contents	Width mm	Height mm	Depth mm	Pieces	Weight kg
6140090	D 19 IMU-10	Ratchet 1993 U-10T Inserts D 19 10 11 12 13 14 15 17 19 22 24 27 30 IN 19 5 6 7 8 10 12 14, IS 19 8 10, ICS 19 2 3 Accessories 1/2" Extension 1990-5-10, Universal joint 1995	425	55	277	27	6,8

19 V20U-20
1/4"+1/2" SOCKET SET
 81 pieces

- > 1/4" + 1/2" sockets
- > With robust lever-change reversible ratchet, with push-button release

€433,61
 + VAT



mm UNIT DRIVE
 12,5 1/2" 6,3 1/4"
 6,3 1/4" 8 5/16"

Code	No.	Contents	Width mm	Height mm	Depth mm	Pieces	Weight kg
1550691	19 V20 U-20	Ratchet 1/2" 1993 U-20, 1/4" 2093 U-20 Inserts 1/2", 19 10 11 12 13 14 15 16 17 18 19 21 22 24 27 30 32 36 1/4" Unit-Drive D 20 4 5 5,5 6 7 8 9 10 11 12 13 680 4 4,5 5,5 6,5 685 2 2,5 3 4 5 6 8, 685 X 5 6 8 687 TX T10 T15 T20 T25 T27 T30 T40 690 1 2 3, 690 PZD 1 2 3 885 3 4 5 6 8 10, 885 X 5 6 8 10 12 887 TX T27 T30 T40 T45 T50 Accessories 1/2" Extension 1990-5-10, 1/4" Extension 2090-4 1/4" Square plug-in handle 676, 1/4" Universal joint 2095 620, 699, KB 819	425	57	280	81	6,3

32 E
3/4" SOCKET SET
 14 pieces



- › 3/4" sockets with hexagonal UD profile (No. 32)
- › U-2 with fine toothed, dial change ratchet

from

€342,02
 + VAT

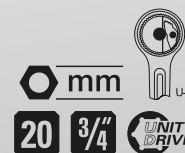

Code	No.	Contents	Width mm	Depth mm	Pieces	Weight kg	excl. VAT
6280180	32 EMZ	Ratchet 3293 Z-94 Inserts 32 22 24 27 30 32 36 38 41 46 50 Accessories Sliding T-handle 3287 3/4" Extension 3290-8-16	525	73	14	11,4	351,26
6280340	32 EMU-2	Ratchet 3293 U-2 Inserts 32 22 24 27 30 32 36 38 41 46 50 Accessories Sliding T-Handle 3287 3/4" Extension 3290-8-16	525	73	14	11,6	342,02

D 30 GMU-3
3/8" SOCKET SET
 17 pieces

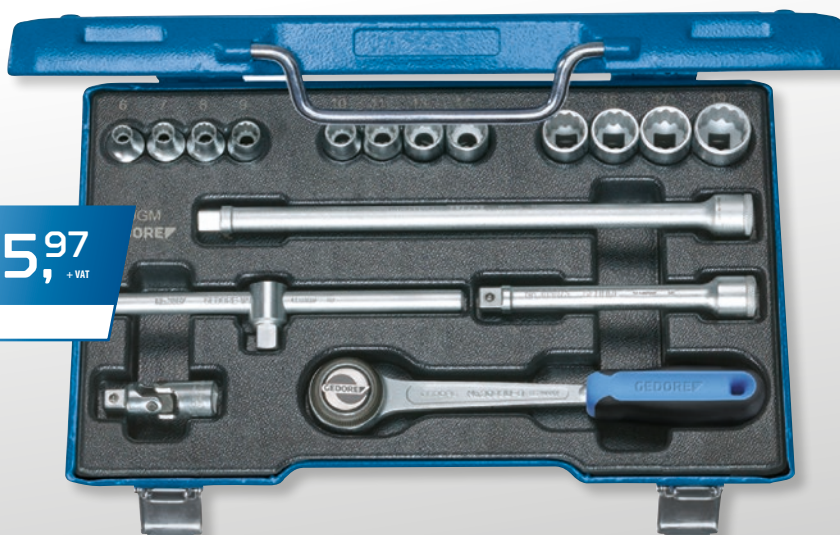

€215,97
 + VAT

- › With forged, tempered, hand-operated Bi-hex UD profile (No. D 30) sockets
- › U-3 range with extra fine toothed reversible ratchet, 72 teeth



Code	No.	Contents	Width mm	Height mm	Depth mm	Pieces	Weight kg
6240200	D 30 GMU-3	Ratchet 3093 U-3 Inserts D 30 6 7 8 9 10 11 13 14 15 16 17 19 Accessories 3/8" Sliding T-handle 3087 3/8" Extension 3090-5-10 3/8" Universal joint 3095	320	55	210	17	2,7

NEW

IMPACT SOCKET SET FOR WS 10 - 27

10 impact sockets for all commonly used compressed air and electric wrenches.

The **10-piece impact socket set 1/2" K 19 L-010** from GEDORE combined with hand tools or an impact wrench is ideal for repair and assembly work. Equipped for every event – every commonly used wrench size is covered with the extensive set in WS 10-27. The sockets are suitable for both manual operation and use with an impact wrench. Clear markings in the case show the respective wrench size, so everything is kept in its place. All packed in a compact plastic box.



Impact socket set 1/2" 10-piece – K 19 L-010

1 EXTENSIVE
10-PIECE SET

2 FOR MACHINE AND
MANUAL OPERATION

3 CLEAR WRENCH
SIZE MARKING
IN THE CASE



*SCREWING
WITH POWER*

K 19 L-010
1/2" IMPACT SOCKET SET

long, 10 pieces

- > 10-piece set that covers the most common wrench sizes
- > Even deeper lying screws can be reached without additional extension
- > Suitable for machine and manual operation
- > Clear marking of the wrench widths in the case
- > In compact plastic case



Code	No.	Contents	Width mm	Height mm	Depth mm	Pieces	Weight kg
3459195	K 19 L-010	1/2" Deep Impact sockets, hexagon 10 13 16 17 18 19 21 22 24 27	360	60	140	10	2,97

K 19-015
1/2" IMPACT SOCKET SET
 15 pieces

- > Comprehensive 1/2" Impact socket set from 10 - 30mm
- > Clear marking of the wrench widths in the case
- > Suitable for machine and manual operation
- > In compact plastic case



Code	No.	Contents	Width mm	Height mm	Depth mm	Pieces	Weight kg
3459187	K 19-015	1/2" Impact sockets hexagon 10 11 12 13 14 15 16 17 18 19 21 22 24 27 30	260	60	146	15	2,14

K 32-008
3/4" IMPACT SOCKET SET
 8 pieces

- > Basic 3/4" impact socket set with the most common sizes from 24 - 41mm
- > Clear marking of the wrench widths in the case
- > Suitable for machine and manual operation
- > In compact plastic case



Code	No.	Contents	Width mm	Height mm	Depth mm	Pieces	Weight kg
3459209	K 32-008	3/4" Impact sockets hexagon 24 27 30 32 36 41 Safety ring Safety pin	285	80	221	8	3,36

K 19-028
**1/2" IMPACT
 SOCKET SET**
 5 pieces

€40,⁶⁶
 + VAT



- > 5 power screwdriver inserts suitable for all standard pneumatic and electric screwdrivers
- > With square drive according to DIN 3121 - G 12.5, ISO 1174



Code	No.	Contents	Width mm	Height mm	Depth mm	Pieces	Weight kg
1646923	K 19-028	10 13 17 19 24	215	50	120	5	0,749

K 19-007
**1/2" IMPACT
 SOCKET SET**
 7 pieces

€45,¹²
 + VAT



- > 6 Impact sockets suitable for all common compressed air and electric screwdrivers
- > With square drive as per DIN 3121 - G 12.5, ISO 1174
- > 1 Impact socket extension 75mm with ball lock on the square
- > Surface phosphated

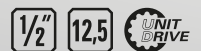

Code	No.	Contents	Width mm	Height mm	Depth mm	Pieces	Weight kg
3437426	K 19-007	1/2" Impact sockets hexagon 10 13 17 19 21 24 1/2" Impact socket extension KS, 75 mm	215	50	120	7	1,1

K 19 LS-004
**1/2" IMPACT
 SOCKET SET**
 4 pieces

€63,²⁷
 + VAT



- > 4 Deep Impact sockets set with protective sleeve, hexagon
- > Machine-operated, suitable for all standard electric and air tools
- > With square drive as per DIN 3121 - G 12.5, ISO 1174
- > Thin-walled to protect the light alloy rims

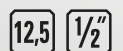

Code	No.	Contents	Length mm	Pieces	Weight kg
2790831	K 19 LS-004	K 19 LS 17 19 21 22	121	4	0,98

STRONG POWERHOUSE

i IMPACT-FIX LOCK

YOUR ADVANTAGES?

- Integrated, secure two-pin lock including ring.
- An extra feature from GEDORE - for increased safety in the workplace.
- Particularly suitable for working in sensitive areas permanently governed by certainty against loss, process reliability and occupational safety.
- Examples: overhead power line construction, wind power plants, machine engineering or the automotive sector.



- Very safe and extremely practice-oriented, and very easy to handle.
- Double ring groove for easily sliding the ring.
- Minimisation of the risk of injury compared to standard systems available on the market. The securing ring is not catapulted out of the rotating insert if the securing pin tears.
- Wherever major forces prevail, correct and appropriate securing and handling of tools is a key element of good screwed connections.
- Standard practice: the bothersome and awkward fitting of the loose securing pin and ring is often simply neglected or forgotten, or the pin and ring are no longer to be found.
- Thanks to the Impact-Fix lock integrated in the socket, 3 elements no longer need to be installed (insert, pin and ring). The securing pins and rings are always secured to the socket (3 in 1). The pins are automatically pressed into the drill holes in the square drive when the ring is secured in place.

EASY TO USE ...

Double ring groove for easily sliding the ring thanks to integrated two-pin lock including ring.

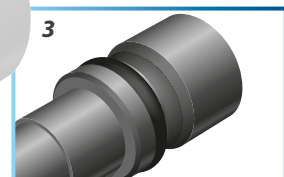
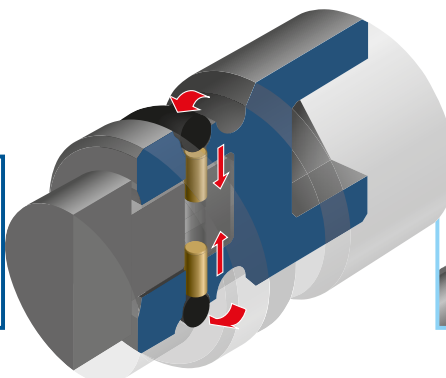
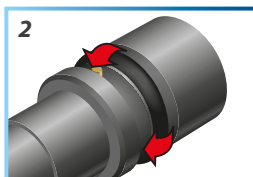
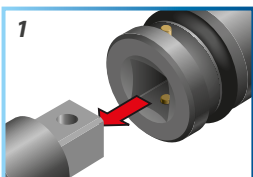

K 32 S

3/4" IMPACT SOCKET WITH IMPACT-FIX LOCK

hexagon UD profile

from **€15,87**
+ VAT



- › Especially ideal for work in sensitive areas where loss prevention, process safety and occupational health and safety are a permanent concern
- › Machine-operated, suitable for all standard electric and air tools
- › Patented
- › Integrated spring pin lock guarantees easy and safe handling



Code	No.	Width across flats mm	Working length mm	Insert-Ø 1 mm	Insert-Ø 2 mm	Operating depth mm	Weight kg	€ excl. VAT
2734060	K 32 S 17	17	45,0	31,1	44,0	7,0	0,4	15,87
2734079	K 32 S 18	18	45,0	32,4	44,0	8,4	0,42	16,29
2734095	K 32 S 19	19	45,0	33,6	44,0	8,4	0,4	16,71
2734176	K 32 S 22	22	46,0	37,4	44,0	9,8	0,4	17,22
2734184	K 32 S 24	24	46,0	38,9	44,0	11,2	0,34	17,72
2734206	K 32 S 27	27	48,0	43,6	44,0	12,6	0,4	18,06
2734214	K 32 S 30	30	52,0	47,4	44,0	14,0	0,4	18,82
2734230	K 32 S 32	32	52,0	49,9	44,0	15,4	0,4	20,83
2734257	K 32 S 33	33	54,0	51,0	44,0	15,4	0,4	23,94
2734265	K 32 S 34	34	54,0	52,4	44,0	15,4	0,4	26,21
2734273	K 32 S 36	36	56,0	54,9	44,0	16,8	0,5	27,13
2734281	K 32 S 38	38	59,0	57,0	44,0	16,8	0,5	28,06
2734303	K 32 S 41	41	59,0	61,1	44,0	18,9	0,56	31,17

K 32 SL

3/4" IMPACT SOCKET WITH IMPACT-FIX LOCK

hexagon UD profile, long pattern

from **€23,52**
+ VAT



- › Especially ideal for work in sensitive areas where loss prevention, process safety and occupational health and safety are a permanent concern
- › Machine-operated, suitable for all standard electric and air tools
- › Patented
- › Integrated spring pin lock guarantees easy and safe handling



Code	No.	Width across flats mm	Working length mm	Insert-Ø 1 mm	Insert-Ø 2 mm	Operating depth mm	Weight kg	€ excl. VAT
2734311	K 32 SL 17	17	90,0	31,1	44,0	7,0	0,56	23,52
2734338	K 32 SL 19	19	90,0	32,4	44,0	8,4	0,6	23,94
2734346	K 32 SL 21	21	90,0	36,1	44,0	9,8	0,6	25,12
2734354	K 32 SL 22	22	90,0	37,4	44,0	9,8	0,62	26,21
2734362	K 32 SL 24	24	90,0	39,9	44,0	11,2	0,62	27,13
2734370	K 32 SL 27	27	90,0	43,5	44,0	12,6	0,6	28,06
2734389	K 32 SL 30	30	90,0	47,4	44,0	14,0	0,6	34,36
2734397	K 32 SL 32	32	90,0	49,9	44,0	15,4	0,7	36,63
2734400	K 32 SL 33	33	90,0	51,0	44,0	15,4	0,8	40,66
2734427	K 32 SL 36	36	90,0	54,9	44,0	16,8	0,8	41,59
2734435	K 32 SL 41	41	90,0	61,1	44,0	18,9	0,98	45,20

K 21 S

1" IMPACT SOCKET WITH IMPACT-FIX LOCK

hexagon UD profile

from **€26,04**
+ VAT



- > Especially ideal for work in sensitive areas where loss prevention, process safety and occupational health and safety are a permanent concern
- > Machine-operated, suitable for all standard electric and air tools
- > Patented
- > Integrated spring pin lock guarantees easy and safe handling



Code	No.	Width across flats mm	Working length mm	Insert-Ø 1 mm	Insert-Ø 2 mm	Operating depth mm	Weight kg	€ excl. VAT
2734443	K 21 S 22	22	55,0	40,4	54,0	9,8	0,6	26,04
2734451	K 21 S 24	24	55,0	42,9	54,0	11,2	0,6	27,13
2734478	K 21 S 27	27	55,0	46,7	54,0	12,6	0,6	27,55
2734486	K 21 S 30	30	57,0	50,4	54,0	14,0	0,6	28,23
2734494	K 21 S 32	32	57,0	52,9	54,0	15,4	0,6	28,73
2734508	K 21 S 33	33	57,0	54,0	54,0	15,4	0,6	32,09
2734516	K 21 S 34	34	57,0	55,4	54,0	15,4	0,6	32,34
2734524	K 21 S 36	36	60,0	57,9	54,0	16,8	0,68	33,44
2734540	K 21 S 38	38	64,0	60,4	54,0	16,8	0,7	37,55
2734559	K 21 S 41	41	64,0	64,2	54,0	18,9	0,7	37,97
2734567	K 21 S 42	42	64,0	65,4	54,0	18,6	0,7	41,17
2734575	K 21 S 46	46	69,0	70,4	54,0	21,0	0,7	41,59
2734583	K 21 S 50	50	72,0	75,4	54,0	23,1	0,8	46,97
2734591	K 21 S 55	55	76,0	81,7	54,0	25,2	0,8	50,58
2734605	K 21 S 60	60	82,0	87,9	54,0	27,3	0,8	56,97
2734613	K 21 S 65	65	85,0	94,2	54,0	29,4	0,9	85,71
2734621	K 21 S 70	70	88,0	100,4	54,0	31,5	0,9	101,68
2734648	K 21 S 75	75	92,0	106,0	54,0	33,6	0,9	113,45
2734656	K 21 S 80	80	97,0	113,0	54,0	36,4	1	123,53

K 21 SL

1" IMPACT SOCKET WITH IMPACT-FIX LOCK

hexagon UD profile, long pattern

from **€41,17**
+ VAT



- > Especially ideal for work in sensitive areas where loss prevention, process safety and occupational health and safety are a permanent concern
- > Machine-operated, suitable for all standard electric and air tools
- > Patented
- > Integrated spring pin lock guarantees easy and safe handling



Code	No.	Width across flats mm	Working length mm	Insert-Ø 1 mm	Insert-Ø 2 mm	Operating depth mm	Weight kg	€ excl. VAT
2734664	K 21 SL 22	22	100,0	40,4	54,0	9,8	0,6	41,17
2734672	K 21 SL 24	24	100,0	42,9	54,0	11,2	0,6	41,59
2734680	K 21 SL 27	27	100,0	46,7	54,0	12,6	0,6	45,20
2734699	K 21 SL 30	30	100,0	50,4	54,0	14,0	0,8	47,89
2734702	K 21 SL 32	32	100,0	52,9	54,0	15,4	0,8	49,24
2734710	K 21 SL 33	33	100,0	54,0	54,0	15,4	0,8	49,49
2734729	K 21 SL 34	34	100,0	55,4	54,0	15,4	1	49,74
2734737	K 21 SL 36	36	100,0	57,9	54,0	16,8	1	50,58
2734745	K 21 SL 38	38	100,0	60,4	54,0	16,8	1,14	57,81
2734753	K 21 SL 41	41	100,0	64,2	54,0	18,9	1,28	59,66
2734761	K 21 SL 46	46	100,0	70,4	54,0	18,9	1,42	74,11

INDUSTRIAL QUALITY PRECISION TORQUE WRENCH

The TORCOFIX is a torque wrench that ensures easy adjusting and operation for the user. Adjustment is made by turning the handle; locking is on the handle end. With an adjusted accuracy of +/- 3 % from the reading value, the TORCOFIX works like a Swiss clock.

The **TORCOFIX TF-K/TF-SE** from GEDORE provides the user significant benefits for optimum handling. The Torcofix torque wrenches are provided in the 1-850 Nm performance range. The torque is adjusted by turning the handle; locking is on the handle end. The fixing recesses form an optimum counter-hold when adjusting the torque. The double scale with Nm and lbf-ft is provided under a viewing window with magnifying effect for better readability. The ergonomic handle ensures a centred hand position

and optimum power transmission; the trigger signal is clearly tangible and audible. Thanks to a sturdy, painted tubular steel structure and highly precise mechanics in the inside, the TORCOFIX more than meets the high industry and trades requirements.



from **€143,70** + VAT

Torcofix torque wrench 1-850 Nm – TF-K/TF-SE

1 CONTROLLED
1-850 NM TIGHTENING

2 EASIER TORQUE
ADJUSTMENT WITH
FIXING RECESSES

3 ERGONOMIC
HANDLE SHAPE

4 SCALE POSITION
PROVIDES BETTER
READABILITY



TF-K TORQUE WRENCH TORCOFIX TF-K

1-850 Nm / 0,75-630 lbf·ft

- > Controlled screw tightening in the range of 1 - 850 Nm / 0,75 - 630 lbf·ft
- > Incl. traceable test certificate (DIN EN ISO 6789-2:2017)
- > For controlled bi-directional tightening
- > New ergonomic handle, shaped according to the natural grip position of the hand
- > Vertical alignment of the scale, torque adjustment therefore suitable for left and right handers
- > Scale line positioned directly above the scale prevents reading errors (parallax errors)
- > Unit labeling integrated in the scale frame and also protected by viewing windows



223 - 1.390 mm



Code	No.	Type	Square drive inch	Square drive metric mm	Nonius	Height mm	Nm	Housing - square centre spacing mm	Length mm	Head width mm	Head height mm	Weight kg	excl. VAT.
3288226	TF-K5	Mushroom head	1/4"	6,3	0,25	39,8	1-5	17,5	223	35,0	25,3	0,33	143,70
3288234	TF-K25	Mushroom head	1/4"	6,3	1	39,8	5-25	17,5	273	35,0	25,3	0,38	146,22
3288242	TF-K50	Mushroom head	3/8"	10	2,5	39,8	10-50	17,5	303	35,0	25,3	0,42	150,42
3278379	TF-K100	Mushroom head	1/2"	12,5	5	44	20-100	22	400	44,0	36	0,97	152,94
3278387	TF-K200	Mushroom head	1/2"	12,5	10	45	40-200	22	495	44,0	36	1,18	161,34
3278395	TF-K300	Mushroom head	1/2"	12,5	10	47	60-300	22	585	46,0	36	1,37	197,48
3278409	TF-K400	Push-through square	3/4"	20	10	52	80-400	31,25	690	62,5	31	1,93	333,61
3278492	TF-K550	Push-through square	3/4"	20	10	51	110-550	34,5	965	69,0	31	3,6	528,57
3278514	TF-K850	Push-through square	3/4"	20	10	51	250-850	34,5	1.390	69,0	31	4,8	703,36

TF-SE TORQUE WRENCH TORCOFIX TF-SE

5-400 Nm / 3,7-300 lbf·ft

- > For controlled clockwise and anti-clockwise tightening (change insertion tool for change of direction)
- > Controlled screw tightening in the range of 5 - 400 Nm / 3.7 - 300 lbf·ft
- > Incl. traceable test certificate (DIN EN ISO 6789-2:2017)
- > New ergonomic handle, shaped according to the natural gripping position of the hand
- > Vertical alignment of the scale, torque setting therefore suitable for left and right-handers
- > Scale mark positioned directly above the scale, prevents reading errors (parallax errors)



€116,⁸¹_{+ VAT}

from

261,5 - 657 mm

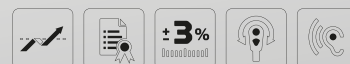

Code	No.	Drive connector rectangular	Nm	Scale division Nm	vernier Nm	Total length mm	Calibration length	Stitch size mm	Weight kg	excl. VAT
3288196	TF-SE25	9 x 12 mm	5-25	1	0,1	261,5	261,5	17,5	0,3	116,81
3288218	TF-SE50	9 x 12 mm	10-50	2,5	0,25	291,5	236,5	17,5	0,35	125,21
3278522	TF-SE100	9 x 12 mm	20-100	5	0,5	378	310,3	17,5	0,77	134,45
3278530	TF-SE150	9 x 12 mm	30-150	10	1	469	401,3	17,5	0,93	152,94
3278549	TF-SE200	14 x 18 mm	40-200	10	1	479	411,3	25,0	1,01	161,34
3278557	TF-SE300	14 x 18 mm	60-300	10	1	570	502,3	25,0	1,19	179,83
3278565	TF-SE400	14 x 18 mm	80-400	10	1	657	589,3	25,0	1,62	269,75



TORCOFIX TF-FS

Pre-set Torcofix 5-200 Nm

TRIED AND TESTED MECHANICS

The pre-set Torcofix torque wrenches are an efficient solution for industrial and repeated torque applications. The safety cap on the end of the handle prevents unwanted adjustment of the torque value and effectively protects the adjustment mechanism from getting dirty. The slim handle structure means the user feels the precise triggering very well.

SAFETY

The safe and long-term torque testing solution excels with its extremely long service life and with the intuitive handling ensures perfect results. The Torcofix TF-FS meets the requirements of DIN EN ISO 6789:2017-2 and comes with the relevant test certificate.

- The Torcofix TF-FS with SE 9x12 and 14x18 mount will be available from May 2024.
- 4 models: TF-FS25, TF-FS50, TF-FS85, TF-FS200. Prices on request
- Optional locking and adjustment tool (TF-EFS)



Code	No.	Drive connector rectangular	Nm	Calibration length	Total width	Total length	Weight kg
3288250	TF-FS25	9 x 12 mm	5-25	133,5	22	186	0,3
3288269	TF-FS50	9 x 12 mm	10-50	193,5	22	246	0,27
3288277	TF-FS85	9 x 12 mm	17-85	276,5	22	329	0,34
3288285	TF-FS200	14 x 18 mm	40-200	345,5	33	410	0,75

7412 RECTANGULAR REVERSIBLE RATCHET HEAD 9x12

- › For solving difficult assembly problems
- › SE mounting 9x12
- › 1/4" to 30 Nm continuous load capacity
- › 3/8" to 135 Nm continuous load capacity
- › 1/2" to 150 Nm continuous load capacity

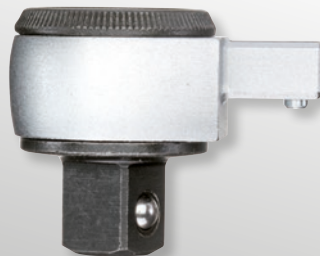

from **€63,²⁷** + VAT

Code	No.	Drive connector square	Drive connector square mm	Return angle	Head height mm	Head width mm	Depth gauge mm	Permanent load capacity	Weight kg	excl. VAT
7672710	7412-00	1/4"	6,3	5	16,6	25	17,5	1/4" = 30 N·m	0,06	63,27
7686500	7412-01	3/8"	10	5	23,2	34	17,5	3/8" = 135 N·m	0,14	70,50
7687230	7412-02	1/2"	12,5	5	24,2	34	17,5	1/2" = 150 N·m	0,15	72,26

7418 RECTANGULAR REVERSIBLE RATCHET HEAD 14x18

- › For solving difficult assembly problems
- › SE mounting 14x18
- › 1/2" to 340 Nm continuous load capacity
- › 3/4" to 400 Nm continuous load capacity

from **€72,²⁶** + VAT



Code	No.	Drive connector square	Drive connector square mm	Return angle	Head height mm	Depth gauge mm	Permanent load capacity	Weight kg	excl. VAT
7687580	7418-02	1/2"	12,5	7,2	28,8	25,0	1/2" = 340 N·m	0,363	72,26
7687660	7418-04	3/4"	20	7,2	35,5	33,0	3/4" = 400 N·m	0,79	90,67

SUKSE
RECTANGULAR RING
RATCHET SPANNER
reversible 9x12

- › UD profile, fine toothed
- › Switch lever for right/left rotation
- › To operate with a 9x12 mm torque wrench or rectangular handle 9x12 mm

from **€54,¹⁹**
+ VAT

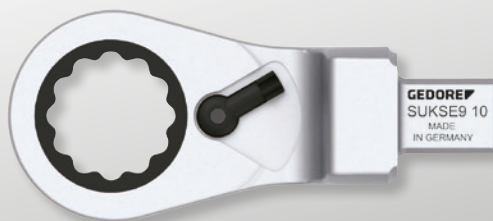

Code	No.	Width across flats mm	Return angle	Head height mm	Head width mm	Depth gauge	Weight kg	excl. VAT
2827735	SUKSE9 10	10	7°	7,7	21	40,0	0,07	54,19
2827743	SUKSE9 13	13	7°	9	25,7	42,0	0,09	55,12
2827751	SUKSE9 17	17	6°	10,6	33,6	45,0	0,13	56,97

3549 UK - 3550 UK
TORQUE WRENCH
TORCOFLEX UK
1-550 Nm

- › Adjustable, releasing and sturdy tubular torque wrench with integrated lever ratchet (from 3/4 inch with change disk) and with square drive for industry and the trades
- › Classified according to DIN EN 6789:2017 Type II Class A, calibrated to a maximum permissible deviation of +/- 3 % and thus more precise than the +/- 4 % required in the standard
- › Incl. test certificate according to DIN EN ISO 6789-2:2017
- › For controlled directional tightening



from **€107,⁵⁶**
+ VAT



Code	No.	Type	Square drive inch	Square drive metric mm	Nonius	Height mm	Nm	Housing - square centre spacing mm	Length mm	Head width mm	Head height mm	Weight kg	excl. VAT.
2958007	3549-00 UK	Reversible ratchet	1/4"	6,3	0,25	34	1-5	12,5	225	25,0	15	0,61	107,56
2958015	3549-02 UK	Reversible ratchet	1/4"	6,3	1	35	5-25	12,5	285	25,0	21,5	0,67	110,08
2958023	3549-05 UK	Reversible ratchet	3/8"	10	2,5	34	10-50	17,5	350	35,0	19,1	0,825	110,92
2958031	3550-10 UK	Reversible ratchet	1/2"	12,5	5	45	20-100	21,25	410	42,5	22	1,38	112,61
2958058	3550-20 UK	Reversible ratchet	1/2"	12,5	10	44	40-200	21,3	500	42,5	22	1,467	116,81
2958066	3550-30 UK	Reversible ratchet	1/2"	12,5	10	44	60-300	21,3	590	42,5	22	1,74	161,34
2958074	3550-40 UK	Reversible ratchet	3/4"	20	10	65	80-400	34	740	68,0	36	3,44	315,13
2958082	3550-55 UK	Reversible ratchet	3/4"	20	10	65	110-550	34	1.000	68,0	36	3,7	432,77

CONTROLLED AND SAFE



3550-UK-LS4 1/2" TORQUE WRENCH TORCOFLEX UK SET 5 pieces

- › Tried-and-tested torque wrench in the 40-200 Nm range with test certificate
- › Controlled clockwise tightening; bi-directional reversible ratchet
- › Classified as per DIN EN ISO 6789-2:2017; adjusted to a maximum permissible +/-3% deviation and thus with a greater precision than the standard-stipulated +/-4%
- › Highly suited for car tyre changing given its 1/2" extension and impact sockets with protective sleeve in the 17, 19 and 21 mm sizes



€152,⁹⁴
+ VAT



Code	No.	Type	Square drive inch	Square drive metric mm	Contents	Nm	Height mm	Housing - square centre spacing mm	Length mm	Head width mm	Head height mm	Pieces	Weight kg
3107027	3550-UK-LS4	Reversible ratchet	1/2"	12,5	Torque wrench TORCOFLEX 40 -200 Nm No. 3550-20 UK Extension No 1990-5 Impact socket set 1/2", 3 pieces	40-200	44	21,3	499	42,5	22	5	2,398

763

TORQUE WRENCH DREMOMETER T-FS

pre-set, 5-12 Nm



€143,⁷⁰
+ VAT

- › Power-saving application for torques which are usually in the range of torque screwdrivers
- › Torque wrench series with 8 fixed preset models for series production, values according to customer requirements on request.
- › For controlled directional tightening
- › Working accuracy acc. to DIN EN ISO 6789-2:2017 Typ II Class E (+/- 6%)
- › With certificate acc. to DIN EN ISO 6789-2:2017, traceable via in-house DAkKS laboratory to national standards



Code	No.	Type	Square drive inch	Square drive metric mm	Height mm	Nm	Housing - square centre spacing mm	Length mm	Weight kg	excl. VAT.
1947958	763-05	Single square rigid	1/4"	6,3	22	5	62,5	100	0,241	143,70
1947966	763-06	Single square rigid	1/4"	6,3	22	6	62,5	100	0,241	143,70
1947974	763-07	Single square rigid	1/4"	6,3	22	7	62,5	100	0,241	143,70
1947990	763-08	Single square rigid	1/4"	6,3	22	8	62,5	100	0,241	143,70
1948008	763-09	Single square rigid	1/4"	6,3	22	9	62,5	100	0,241	143,70
1948016	763-10	Single square rigid	1/4"	6,3	22	10	62,5	100	0,241	143,70
1948032	763-12	Single square rigid	1/4"	6,3	22	12	62,5	100	0,241	143,70

8563-N-05

3/4" TORQUE WRENCH DREMOMETER DNR SET

155-760 Nm

- › Torque wrench 155-760 Nm tightening range with test certificate and extension tube
- › Controlled clockwise tightening; 3/4" output drive; plus clockwise rotating 3/4" add-on ratchet
- › Vernier scale - resolution 1.0 Nm
- › Error-free operation due to length independence
- › Classified as per DIN EN ISO 6789-2:2017; adjusted to a maximum permissible +/-3% deviation and thus with a greater precision than the standard-stipulated +/-4%
- › Matching sheet metal case with insert see page 37

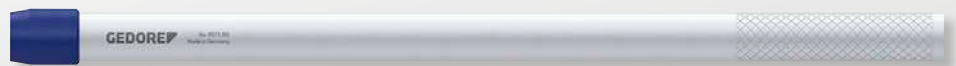

€1083,¹⁹
+ VAT



Code	No.	Type	Square drive inch	Square drive metric mm	Contents	Nm	Height mm	Housing - square centre spacing mm	Length mm	Weight kg
3107043	8563-N-05	Single square	3/4"	40	DREMOMETER DN 3/4" with vernier 155-760Nm No. 8563-N-00 Extension tube DR/DX ALU No. 8571-80 Ratchet head No. 754-04	155-760	35	22,5	812	3,005

NEW

SHEET METAL BOXES FOR DREMOMETERS

2 robust sheet metal boxes for DREMOMETER type D to F with foam inlay

The **sheet metal boxes WK 8563-70-71 and WK 8564-72-81** from GEDORE are the ideal addition to the

DREMOMETER torque spanners type D to F. The robust boxes made of powder-coated steel sheet in stylish GEDORE blue are ideal for storing and safely transporting the DREMOMETER. Alternatively, the empty 4 sheet metal box models can be optionally equipped with the foam configurator tool with customised Check-Tool foam inserts. The centred, ergonomically positioned carrying handle ensures safe handling.



Sheet metal case, optionally with insert for Dremometer type CD - F

1 STABLE AND STURDY DESIGN

2 OPTIONAL: EMPTY VERSIONS + CUSTOMISED FOAM INSERTS

3 IDEAL FOR LONGER TOOLS UP TO 163 CM

4 OPTIMISED TRANSPORT AND STORAGE OPTION

INDIVIDUAL STORAGE

WK 8563-70-71 - WK 8564-72-81
SHEET METAL CASE WITH INLAY
 for DREMOMETER type D-DX or EK-F

- > Optimal transport and storage of DREMOMETER, extension tube and ratchet attachment
- > Robust and stable sheet metal box with foam insert for DREMOMETER type D-DX or EK-F
- > 2 quick-release fasteners for easy opening and secure closing
- > Ideal addition to DREMOMETER (p.35, 38, 39)

from
€197,00 + VAT



Code	No.	Width mm	Height mm	Depth mm	Weight kg	excl. VAT.
3254895	WK 8563-70-71	865	84	207	3,8	197,00
3254909	WK 8564-72-81	1.052	84	247	5,1	249,00

WK
METAL BOXES „EMPTY“
 different sizes

- > For transporting and storing torque wrenches
- > Empty metal boxes including individual foam inserts price on request
- > Optional: Equipped with foam inserts "Schaumstoffkonfigurator"

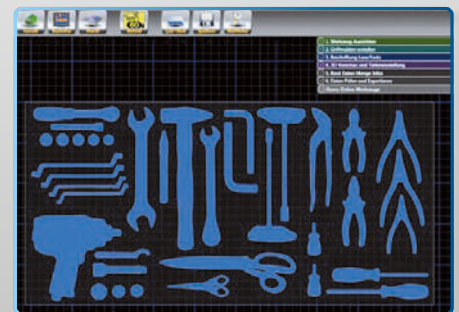

Code	No.	Width mm	Height mm	Depth mm	Weight kg
3254852	WK 1030-90 L	632	84	207	2,7
3254860	WK 1031-90 L	865	84	207	3,6
3254879	WK 1032-90 L	1.052	84	247	4,9
3254887	WK 1033-90 L	1.632	84	207	9,6

HIGHEST ACCURACY



Matching sheet metal case see p. 37

8571 DX - 8576 DXL TORQUE WRENCH DREMOMETER

520-1000 Nm / 380-730 lbf-ft

- › Controlled screw tightening in the range of 520 - 1000 Nm / 380 - 730 lbf-ft
- › For use in almost all industrial manufacturing areas
- › Audible and perceptible, automatic short-path triggering
- › Error-free operation - no change in torque values when operated outside the handle. Not length dependent
- › Single scale for measuring range in Nm
- › Highest accuracy max. deviation of +/- 3
- › Certificate according to DIN EN ISO 6789:2017 part 2
- › Save effort using the optional extension tubes
- › Matching metal box with insert see page 37



8571-01



8576-01

€1047,⁰⁶ + VAT

from



Code	No.	Type	Square drive inch	Square drive metric mm	Contents	Height mm	Nm	Housing - square centre spacing mm	Length mm	Head width mm	Head height mm	Weight kg	excl. VAT.
7694010	8571-01	Single square rigid	3/4"	20	ALU extension tube No. 8571-80	60	520-1000	22,5	812	45,0	35	4,25	1047,06
7694360	8576-01	Double square rigid	3/4"	20	ALU extension tube No. 8571-80	35	520-1000	22,5	812	45,0	35	5,6	1083,19

8564 E - 8569 EL TORQUE WRENCH DREMOMETER

750-2000 Nm

- › Controlled screw tightening in the range of 750 - 2000 Nm
- › For use in almost all industrial manufacturing areas
- › Audible and perceptible, automatic short-path triggering
- › Error-free operation - no change in torque values when operated outside the handle. Not length dependent
- › Single scale for measuring range in Nm
- › Highest accuracy max. deviation of +/- 3
- › Certificate according to DIN EN ISO 6789:2017 part 2
- › Save effort using the optional extension tubes
- › Matching metal box with insert see page 37



from **€1805,88**
+ VAT

from



Code	No.	Type	Square drive inch	Square drive metric mm	Contents	Height mm	Nm	Housing - square centre spacing mm	Length mm	Head width mm	Head height mm	Weight kg	excl. VAT.
7695250	8564-01	Single square rigid	1"	25	Extension tube 8564-92, 8572-74	71	750-2000	30	932	60,0	40	12	1805,88
7695410	8569-01	Double square rigid	1"	25	Extension tube 8564-92, 8572-74	71	750-2000	30	932	60,0	40	12	1895,80

TSN TORQUE WRENCH TSN SLIPPER

1-55 Nm / pre-set

- › Controlled screw tightening in the range 1-55 Nm
- › Serial / production-line
- › Extremely long-term work
- › Pre-set production torque wrench - without scale
- › Release accuracy: +/- 4% tolerance of the set value (TSN 5/45 and TSN 10/90 +/- 6% tolerance)
- › Precision mechanism slips very noticeably and audibly („click“) when the pre-set value is achieved - over-tightening is not possible
- › Test certificate acc. to DIN EN ISO 6789



from **€197,48**
+ VAT

from

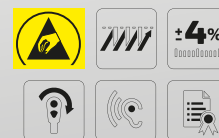

Code	No.	Type	Square drive inch	Square drive metric mm	Nm	Length mm	Weight kg	excl. VAT.
1196650	TSN 5/45	Single square ratchet	1/4"	6,3	1-5	195	0,19	197,48
1196731	TSN 10/90	Single square ratchet	1/4"	6,3	2-10	195	0,19	206,72
7091900	TSN 25 D	Single square ratchet	1/4"	6,3	5-25	216	0,34	251,26
7092120	TSN 55	Single square ratchet	3/8"	10	15-55	324	0,8	315,13

BREAKING TORQUE WRENCH WITH LOW RISK OF OVERTIGHTENING

Versatile and flexible torque wrench – ideal for maintenance and repair work. Can be quickly adjusted via the scale and used flexibly with various insertion tools.

The **breaking torque wrench ATB 10 G** from GEDORE provides 2-10 Nm controlled screw tightening. The kink device minimizes the risk of overtightening the screw connection and is therefore simply ideal for delicate work that requires precise torque values and easy intuitive handling. When the torque value is reached the handle kinks up to 20°, making overtightening unlikely. The micrometer scale leaves the user wanting for

nothing. It ensures quick and safe adjustment of the required values. The integrated adjustment safety device means the user cannot unintentionally change set values while working. This produces safe and reproducible work processes.



Breaking torque wrench 2-10 Nm SE9x12 – ATB 10 G

1 MAXIMUM 20° KINK DEVICE ENSURES LOW RISK OF OVERTIGHTENING

2 MICROMETER SCALE FOR QUICK AND PRECISE WRENCH ADJUSTMENT

3 INTEGRATED ADJUSTMENT SAFETY DEVICE PREVENTS THE TORQUE VALUE FROM SHIFTING



THE SAFE
WRENCH

ATB BREAKING TORQUE WRENCH

0,5-10 Nm / with scale

- > With 9x12 mm internal rectangular holder
- > With micrometre scale that enables simple and safe setting of the desired value
- > With adjustment lock to prevent unintentional adjustment of the torque value
- > Triggering accuracy +/- 6 %
- > Handle bends up to 20° when the torque value is reached, making overtightening unlikely
- > Classified according to DIN EN ISO 6789 Type II Class A



from €202,52 + VAT

from



Code	No.	Type	Nm	Length mm	Weight kg	excl. VAT.
2839628	ATB 2.5 G	Rectangular cavity	0,5-2,5	192	0,27	202,52
2839636	ATB 5 G	Rectangular cavity	1-5	230	0,29	207,56
2839644	ATB 10 G	Rectangular cavity	2-10	230	0,3	202,52

CL ELECTRONIC TEST DEVICE CAPTURE LITE

0,25 - 350 Nm



- > Digital torque tester for testing torque wrenches and torque screwdrivers
- > Measuring tolerance +/- 1 % for all readings
- > 3 measuring modes: floating value display (track), kink point detection (first peak), peak value measurement (peak)
- > Simple & Easy operation due to 1-button operation (measuring mode, unit)
- > Switchable between Nm, lbf-ft and lbf-in
- > Power supply and data output via USB connection
- > Stable plastic case with inlay

€990,76 + VAT

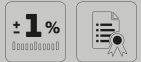

Code	No.	Nm	Drive connector hexagon female mm	Drive connector square female mm	Drive connector square female	Adapter inch	Weight kg	excl. VAT
3119319	CL 10	0,25-10	6,3	6,3	1/4"	1/4" hexagon socket - 1/4" square socket	1,42	990,76
3297896	CL 10 S	0,25-10		6,3	1/4"		1,42	990,76
3297926	CL 350	10-350		12,5	1/2"	3/8"	1,65	990,76

TT3KH ELECTRONIC TORQUE WRENCH TORCOTRONIC III

10-350 Nm / 7.4-258.2 lbf-ft

- > Torque and torque angle measure
- > 4 different measuring modes
- > 5 parameters storable
- > USB interface for data exchange
- > 2000 storage places
- > Measurement accuracy torque +/- 1 %, +/- 1 digit
- > Measurement accuracy torque angle +/- 1 %, but min. +/- 1° on 360° with min. 4°/sec



from €814,29 + VAT

from



Code	No.	Type	Square drive inch	Square drive metric mm	Height mm	Nm	Length mm	Weight kg	excl. VAT.
2648636	TT3KH 120	Rectangular cavity	1/2"	12,5	31,5	10-120	670	1,2	814,29
2648644	TT3KH 350	Rectangular cavity	1/2"	12,5		70-350	900	1,74	990,76

DVV-13Z
TORQUE MULTIPLIER
DREMOPLUS ALU
 1300 Nm / 950 lbf-ft

€990,76
 + VAT



- > Controlled screw tightening and loosening
- > With a single-stage planet gear
- > High-performance aluminium housing
- > Better than +/- 3 % accuracy
- > To operate with a suitable torque wrench
- > Optionally retrofittable with straight reaction arm L-shaped



Code	No.	Output torque (max.) Nm	Output torque (max.) lbf-ft	Multiplication ratio	Version reaction arm	Drive square inch	Output square	Weight kg
2653370	DVV-13Z	1300	950	1:5	Z-Form, cranked	1/2"	3/4"	1,3

DVV-13ZG
TORQUE MULTIPLIER SET



€1041,18
 + VAT



- > For industry, construction sites, commercial vehicle and automotive workshops, agricultural engineering, bridge, ship, aircraft and railroad construction, refineries, mechanical engineering and plant construction, maintenance
- > Mechanical hand torque multiplier for controlled screw tightening and unloosening screw connections
- > High-performance aluminium housing
- > Can be optionally retrofitted with L-form straight reaction arm - with adjustable reaction arm - of lightweight metal
- > The set contains three different 3/4" Impact sockets 27, 30, 32 mm
- > Output square with hole for Impact sockets with locking pin and ring
- > In transport case with foam insert



Code	No.	Contents	Length mm	Weight kg
2653389	DVV-13ZG	DVV-13Z, K 32 27, K 32 30, K 32 32	230	3

DVI-28Z / DVI 28L
TORQUE MULTIPLIER
DREMOPLUS ALU
 2000-2800 Nm / 1500-2050 lbf-ft

- > For industry, construction sites, commercial vehicle and automotive workshops, agricultural engineering, construction machinery, bridge, ship, aircraft, railroad construction, refineries
- > Output square with hole for Impact sockets with locking pin and ring
- > Weight-reduced aluminum housing / -reactive (DVI-28L only)



€1259,66
 + VAT
 from



Code	No.	Output torque (max.) Nm	Output torque (max.) lbf-ft	Multiplication ratio	Version reaction arm	Output square	Weight kg	excl. VAT
2653257	DVI-28L	2800	2050	1:5,5	L-Form, straight	1"	2,4	1713,45
2653273	DVI-28Z	2800	2050	1:5,5	Z-Form, cranked	1"	2,4	1259,66

SK 2154 PH-06

3C-SCREWDRIVER SET WITH STRIKING CAP

6 pieces



- › For firmly seated slotted and cross-recess screws PH
- › With an additional hexagon drive on the hexagonal blade and striking cap
- › Ergonomic 3-component handle Power-Grip³ for maximum power transmission with minimum stress on the hand
- › Hanging hole on handle for space-saving storage

€31,67
+ VAT



Code	No.	Contents
1878743	SK 2154 PH-06	Screwdriver with striking cap slotted No. 2154SK, 4.5 5.5 6.5 8 mm Screwdriver with striking cap Phillips No. 2160SK PH, 1 2 mm

Pieces	Weight kg
6	0,88

2150-2160 PH

3C-SCREWDRIVER SET



- › For slotted and PH Screws
- › Ergonomic 3-component handle Power-Grip³ for maximum power transmission with minimum stress on the hand
- › Hanging hole on handle for space-saving storage
- › Type of drive marked at end of the handle

€18,98
+ VAT

from



Code	No.	Contents
1482319	2150-2160 PH-06	3C screwdriver slotted No. 2150, 4.5.5 6.5 8 mm 3C screwdriver phillips. 2160 PH, 1 2
1482343	2150-2160 PH-010	3C-Screwdriver slotted No. 2150 5.5 6.5 8 3C-Screwdriver Phillips No. 2160 PH 1 2, Phase tester 3,5

Pieces	Weight kg	excl. VAT
6	0,66	18,98
10	0,825	35,29

2163 TX-010 3C-SCREWDRIVER SET

10 pieces

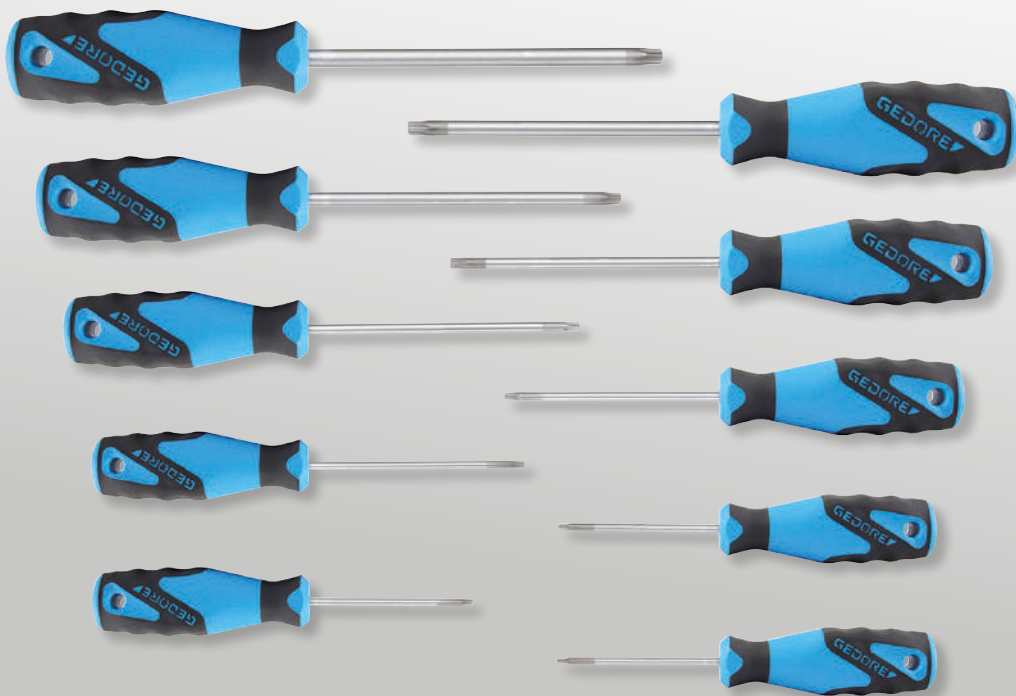

- > Perfect All-rounder for working in wood, plastic and metal for internal TX screws
- > Type of drive marked at end of the handle
- > Ergonomic handle shape for precise, fatigue-free work
- > Positive-fit joint of handle and blade for optimum transmission of force

€63,²⁷
+ VAT



Code	No.	Contents
1482335	2163 TX-010	2163 TXT 7 8 9 10 15 20 25 30 27 40

Pieces	Weight kg
10	0,74

DT 2142-008 OFFSET ALLEN KEY SET

8 pieces



- > For in-hex screws
- > With two hexagons, same size each end
- > Long blade with ball end
- > 2-component T-handle for high torque when loosening or tightening

€63,²⁷
+ VAT



Code	No.	Contents
3037371	DT 2142-008	Offset screwdriver with 2C-T-handle No. DT 2142, 2 2.5 3 4 5 6 8 10 mm

Length mm	Width mm	Height mm	Pieces	Weight kg
325	320	45	8	0,97

DT 2143 KTX-007
**OFFSET
 TORX ALLEN
 KEY SET**
 7 pieces



- › Popular sizes for recessed TX screws T10 T15 T20 T25 T27 T30 T40
- › With ball end, working angle approx. 25°
- › 2-component T-handle for high torque when loosening or tightening

€98,32
 + VAT

Code	No.	Contents	Width mm	Height mm	Pieces	Weight kg
3037398	DT 2143 KTX-007	Offset screwdriver with 2C-T-handle No. DT 2143 KTX, T10 T15 T20 T25 T27 T30 T40	320	45	7	0,71

H 42 CKEL-09
OFFSET ALLEN KEY SET
 colour coded, 9 pieces



- › For loosening and tightening hexagon socket screws
- › Ball head enables screwing in places that are difficult to access
- › Colour coding simplifies the assignment of the correct key width
- › Abrasion-resistant powder-coated

€32,51
 + VAT

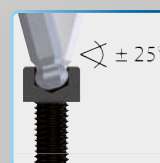

Code	No.	Contents	Pieces	Weight kg
3297470	H 42 CKEL-09	42 CKEL 1,5 2,2,5 3 4 5 6 8 10	9	0,415

H 43 KTX-07
**OFFSET ALLEN
 KEY SET**
 for recessed TX
 head screws, 7 pieces



- › With ball end

€66,88
 + VAT

Code	No.	Contents	Pieces	Weight kg
1531441	H 43 KTX-07	43 KTX T10 T15 T20 T25 T27 T30 T40	7	0,169

GEDORE

COMBINE TOOLS AND TROLLEYS INDIVIDUALLY

WORKSHOP SELECTION

FIND OUT



From ratchets and screwdrivers to bits and customised individual small parts: In the stable and smooth-running tool trolleys and robust workbenches from **GEDORE**, your tools are always safe and clearly organised. Whether for industry, automotive, trade or the private workshop, the mobile workshop helpers.

gedore.com

WSL-M6
**TOOL TROLLEY
 WORKSTER
 SMARTLINE**
 with 6 drawers

€541,¹⁸
 + VAT



- › Work platform with ABS plastic cover with frontal flattening and roll protection edge
- › Side walls with Euro perforation 10 x 38 mm to fix hooks and tools
- › Individual drawer stopping stops more than one drawer being opened, one-handed operation
- › 6 wide drawers (W 480 x D 400 mm) fully extending
- › Load capacity per drawer 20 kg



Code	No.	RAL	Width mm	Height mm	Depth mm	Drawers	Max. load-bearing capacity kg	Number of drawers	Weight kg
3100707	WSL-M6	GEDORE blue, RAL 5017	625	900	510	5x Type 1, H = 80 mm 1x Type 2, H = 160 mm	300	6	48

WSL-M-TS-172
TOOL TROLLEY WORKSTER
 with tool set 172 pieces

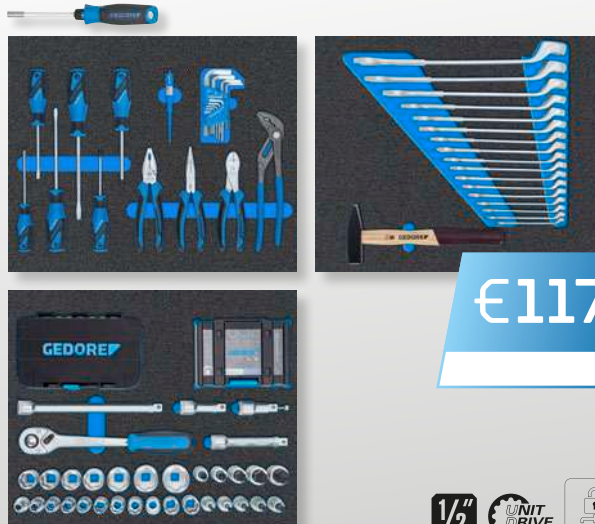

€1175,⁶³
 + VAT

- › Perfect tool combination in check tool modules for industry, trade and the automotive sector
- › Non-slip, with recessed grip
- › Resistant to oil and grease
- › Metric tool sizes
- › In tool trolley No. WSL-M6



Code	No.	Width mm	Height mm	Depth mm	Pieces	Weight kg
3100197	WSL-M-TS-172	625	900	510	172	76,9
Contents						
Combination spanner No. 1 B, 8 10 11 12 13 14 15 16 17 18 19 21 22 24 27 30 32 mm						
Socket No. C19, 8 10 11 12 13 14 15 16 17 18 19 20 21 22 24 27 30 32 mm						
1/2" Screwdriver socket hexagon No. IN19, 5 6 7 8 9 10 12 14 17 19 mm						
1/2" Reversible ratchet No. 1993 U-10 T, 1/2" Extension No. 1990, 75 125 250 mm						
1/2" Extension No. 1990 M, with holding magnet, Bit socket box with ratchet 1/4" 35pcs, No. 666-U-20						
Torsion bit set No. 666-042, 1/4" Ratchet screwdriver SilentGEAR No. 2675 with bit holder						
Offset screwdriver No. H 42-10, hexagon 1.3 1.5 2 2.5 3 4 5 6 8 10 mm						
3C-Screwdriver No. 2150, 4 5.5 6,5 8 mm, 3C-Screwdriver No. 2160 PH 1 2						
Universal pliers No. 142 10 TL, 10", Multiple pliers No. 8133-200 JC, 200 mm						
Power side cutters No. 8316-180 JC, 180 mm, Voltage tester slot No. 4615 3, 220-250 V, 3mm						
Engineer's hammer No. 4 E-500, 500 g, Twist drill set No. 8550-024, Ø 1 1.5 2 2.5 3 3.5 4 4.5 5 5.5 6 6.5 7 7.5 8 8.5 9 9.5 10 10.5 mm						

NEW

MANOEUVRABLE SERVICE TROLLEY - THE PRACTICAL HELPER FOR EVERY WORKSHOP

The service trolley with 3 shelf surfaces provides plenty of space for tools, work utensils and everything else you need.

The **service trolley 1530** from GEDORE is the mobile companion for tools, components and other materials. The three large surfaces ensure safe transporting as well as quick and easy access to materials. The first two shelves have a load capacity of up to 50 kg and the bottom one is up to 100 kg. The height-adjustable middle shelf surface can be moved into 7 different heights. With its castors with rubberised running surface it is also extremely easy to manoeuvre when heavily loaded. The compatibility with predefined GEDORE tool sets in ES and CT modules ensures a flexible range of possible uses.



Service trolley - 1530

1 3 LARGE SHELF SURFACES

2 HEIGHT-ADJUSTABLE MIDDLE SURFACE

3 EASY TO MANOEUVRE

4 COMPATIBLE WITH GEDORE CT AND ES MODULES



EVERYTHING AT HAND - ALWAYS

1530
SERVICE TROLLEY



- > Three large, open-access storage shelves, 200kg total load capacity
- > Flexibility due to height-adjustable middle shelf surface
- > Optimal for mobile use thanks to easy-running swivel castors
- > Compatible with GEDORE tool sets (ES or CT modules) for different applications

€184,03
+ VAT

Code	No.	Width mm	Height mm	Depth mm	Weight kg
3437507	1530	1.075	975	480	35

WSL-L7
**TOOL TROLLEY
WORKSTER
SMARTLINE**
with 7 drawers



- > Working platform with cover made of ABS plastic with front flattening and anti-roll edge, as well as small additional storage compartments
- > Side walls with Euro perforation 10 x 38 mm
- > Individual drawer stopping stops more than one drawer being opened, one-handed operation
- > 7 wide drawers (W 640x D 400 mm) fully extending
- > Load capacity per drawer 20 kg
- > Total load capacity 400 kg

€721,85
+ VAT



Code	No.	RAL	Width mm	Height mm	Depth mm	Drawers	Max. load-bearing capacity kg	Number of drawers	Weight kg
2977311	WSL-L7	RAL 5017	870	1.045	505	5x Type 1, H = 80 mm 2x Type 2, H = 162,5 mm	400	7	85

WSL-L-TS-147

TOOL TROLLEY WORKSTER SMARTLINE WITH TOOL ASSORTMENT IN CT MODULES

147 pieces

- > Perfect tool combination in check tool modules for industry, trade and the automotive sector
- > GEDORE Check-Tool-System: 2-colour foam insert to check that the set is complete
- > Non-slip, with recessed grip
- > Resistant to oil and grease
- > Metric tool sizes
- > In tool trolley No. WSL-L7



Code	No.	Contents	Width mm	Height mm	Depth mm	Pieces	Weight kg
2980312	WSL-L-TS-147	1/4" Reversible ratchet No. 2093 U-20 1/4" Wobble extension No. 2090 KR-4 1/4" T-handle No. 2087 1/4" Socket UD-profile No. D 20 4 5 5.5 6 7 8 9 10 11 12 13 1/4" Socket No. TX 20 E4 E5 E6 E7 E8 E10 1/4" Screwdriver bit slotted No. 680 4 5.5 6.5 8 1/4" Screwdriver bit in-hex No. 685 2.5 3 4 5 6 1/4" Screwdriver bit XZN No. 685 X 5 6 8 1/4" Screwdriver bit PH No. 690 1 2 3 1/4" Screwdriver bit PZ No. 690 PZD 1 2 3 1/4" Screwdriver bit TX No. 687 TX T6 T7 T8 T9 T10 T15 T20 T25 T27 T30 T40 1/4" Multi handle No. 676 1/4" Bit holder No. 699 1/2" Reversible ratchet No. 1993 U-20 1/2" Extension No. 1990-2.1/2 1/2" Wobble extension No. 1990 KR-5 -10 1/2" Socket No. D 19 10 11 12 13 14 15 16 17 18 19 21 22 24 27 30 32 1/2" Screwdriver socket in-hex No. IN 19 5 6 7 8 9 10 12 14 Insert holder 1/4" hexagon - 1/4" square No. 673 6.3 Bit-Adapter 1/4" hexagon - 1/4" square No. 620 Combination spanner UD-profile No. 7 8 9 10 11 12 13 14 15 16 17 18 19 20 21 22 24 Offset screwdriver set No. PH 42-88 (2-10 mm) 3C-Screwdriver slot No. 2154SK 3.5 5.5 6.5 8 3C-Screwdriver PH No. 2160SK PH 1 2 Universal pliers No. 142 10 TL Power combination pliers No. 8250-180 JC Multiple pliers No. 8133-200 JC Power side cutters No. 8316-180 JC Engineer's hammer No. 4 E-500 Centre punch No. 100-12 Pin punch No. 119-1.5 -3 -4 Flat chisel No. 97-250 Cross-cut chisel No. 98-125 Drift punch No. 99 12-5 Twist drill set No. 8550-024	870	1.045	505	147	97

WSL-L-T5-308
TOOL TROLLEY WORKSTER
 with 308-piece tool assortment

- › Perfect tool combination in check tool modules for industry, trade and the automotive sector
- › Metric tool sizes
- › Non-slip, with recessed grip
- › Resistant to oil and grease
- › Metric tool sizes
- › In tool trolley No. WSL-L7



Code	No.	Width mm	Height mm	Depth mm	Pieces	Weight kg
2980347	WSL-L-T5-308	870	1.045	505	308	105,6

Contents

1/4" Reversible ratchet No. 2093 U-20, 1/4" Wobble extension No. 2090 KR-4
 1/4" T-handle No. 2087, 1/4" Socket UD-profile No. D 20 4 5 5.5 6 7 8 9 10 11 12 13
 1/4" Socket No. TX 20 E4 E5 E6 E7 E8 E10, 1/4" Screwdriver bit slotted No. 680 4 5.5 6 5 8
 1/4" Screwdriver bit in-hex No. 685 2.5 3 4 5 6, 1/4" Screwdriver bit XZN No. 685 X 5 6 8
 1/4" Screwdriver bit PH No. 690 1 2 3, 1/4" Screwdriver bit PZ No. 690 PZD 1 2 3
 1/4" Screwdriver bit TX No. 687 TX T6 T7 T8 T9 T10 T15 T20 T25 T27 T30 T40, 1/4" Multi handle No. 676
 1/4" Bit holder No. 699, 1/2" Reversible ratchet No. 1993 U-20, 1/2" Extension No. 1990-2.1/2
 1/2" Wobble extension No. 1990 KR-5 -10, 1/2" Socket insert No. D 19 10 11 12 13 14 15 16 17 18 19 21 22 24 27 30 32
 1/2" Screwdriver socket in-hex No. IN 19 5 6 7 8 9 10 12 14, 1/2" Screwdriver socket XZN No. INX 19 6 8 10 12
 1/2" Screwdriver socket in-hex No. IN 19 L 5-90 6-90 8-90 10-140 12-140 14-140, long
 1/2" Screwdriver socket TX No. ITX 19 T20 T25 T27 T30 T40 T45 T50 T55 T60
 1/2" Screwdriver socket TX No. ITX 19 L T20-100 T25-100 T27-100 T30-100 T40-100 T45-100 T50-100 T55-100 T60-100, long
 1/2" Impact socket bit with protective sleeve No. K 19 LS 17 19 21, 5/16" Screwdriver bit slotted No. 880 7 8 9 12 ST-40
 5/16" Screwdriver bit in-hex No. 885 5 6 8 10, 5/16" Screwdriver bit PH No. 890 1 2 3 4
 3/8" Reversible ratchet No. 3093 U-20 Recoiless hammer No. 248, 3/8" Wobble extension No. 3090 KR-5 -10
 3/8" Socket wrench UD-profile No. D 30 6 7 8 9 10 11 12 13 14 15 16 17 18 19 20 21 22 24
 3/8" Screwdriver socket in-hex No. IN 30 5 6 7 8 10, 3/8" Screwdriver socket XZN No. INX 30 5 6 8 10
 3/8" Screwdriver socket TX No. ITX 30 T20 T25 T27 T30 T40 T45 T50 Insert holder 1/4" hexagon - 1/4" square No. 673 6,3
 Bit-Adapter 1/4" hexagon - 1/4" square No. 620, Adaptor 5/16" hexagon - 1/2" square No. KB 819
 Open-end spanner with ring ratchet UD-profile No. 7 R 8 10 12 13 14 15 16 17 18 19
 Combination spanner UD-profile No. 7 8 9 10 11 12 13 14 15 16 17 18 19 20 21 22 24
 Double open-end spanner No. 6 6x7 8x9 10x11 12x13 14x15 16x17 18x19 20x22 24x27
 Double ring-end spanner UD-profile No. 2 6x7 8x9 10x11 12x13 14x15 16x17 18x19 20x22
 Double ring-end spanner hexagon No. 400 8x10 10x11 12x14 13x15 17x19, open, Allen Key set No. PH 42-88 (2-10 mm)
 Offset screwdriver set No. H 43 TX-09, 3C-Screwdriver slotted No. 2154SK 3.5 5.5 6.5 8, 3C-Screwdriver PH No. 2160SK PH 1 2
 3C-Screwdriver TX No. 2163 TX T10 T15 T20 T25 T30 T40, Nut Driver with 3C handle hexagon No. 2133 5.5 6 7 8 9 10
 Universal pliers No. 142 10 TL, Power combination pliers No. 8250-180 JC, Multiple pliers No. 8133-200 JC
 Power side cutters No. 8316-180 JC, Circlip pliers for external retaining rings No. 8000 A 1 A 2 A 21
 Circlip pliers for internal retaining rings No. 8000 J 1 J 2 J 21, Engineer's hammer No. 4 E-500
 Centre punch No. 100-12, Pin punch No. 119-1.5 -3 -4, Flat chisel No. 97-250, Cross-cut chisel No. 98-125
 Drift punch No. 99 12-5, Twist drill set No. 8550-024, Hacksaw No. 407, Grip pliers 10" No. 137 10
 Steel tape measure, 5m No. 4534-5, Screw remover 1/2" No. K 1900, Cable knife No. 0063-08, Wire brush No. 646
 Pocket vernier calipe No. 710, Key file set No. 8728, Bolt extractor set No. 8551-55, Gasket scraper No. 133 K, Feeler gauge set, fan pattern No. 702 20 M

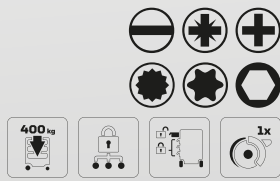

WHL-L7
**TOOL TROLLEY
 WORKSTER**
 with 7 drawers

€898³²
 + VAT



- › Working platform with cover made of ABS plastic with front flattening and anti-roll edge, as well as small additional storage compartments
- › Stainless steel insert in top
- › 5 flat, wide drawers (W 640 x D 400) with full extension
- › 2 high, wide drawers (W 640 x D 400) with full extension
- › Load capacity per drawer 40 kg
- › Total load capacity 500 kg



Code	No.	RAL	Width mm	Height mm	Depth mm	Drawers	Max. load-bearing capacity kg	Number of drawers	Weight kg
3033708	WHL-L7	GEDORE blue, RAL 5017	785	1.045	510	5x Type 1, H = 80 mm 2x Type 2, H = 160 mm	500	7	84

WHL-L7-TS-147
TOOL TROLLEY WORKSTER
 147 pieces



- › Tool set in check tool modules (CT) for industry, trade and the automotive sector
- › Completeness check through 2-coloured foam inserts
- › Non-slip, with recessed grip
- › Resistant to oil and grease
- › Metric tool sizes
- › In tool trolley No. WHL-L7

€1629⁴¹
 + VAT



Code	No.	Height mm	Width mm	Depth mm	Drawers	Number of drawers	Pieces	Weight kg
3082105	WHL-L-TS-147	1.045	785	510	7 drawers: 5x Type 1, H = 80 mm 2x Type 2, H = 160 mm	7	147	97

Contents

1/4" Reversible ratchet No. 2093 U-20, 1/4" Wobble extension No. 2090 KR-4, 1/4" T-handle No. 2087
 1/4" Socket UD-profile No. D 20 4 5 5.5 6 7 8 9 10 11 12 13, 1/4" Socket No. TX 20 E4 E5 E6 E7 E8 E10
 1/4" Screwdriver bit slotted No. 680 4 5.5 6.5 8, 1/4" Screwdriver bit in-hex No. 685 2.5 3 4 5 6, 1/4" Screwdriver bit XZN No. 685 X 5 6 8
 1/4" Screwdriver bit PH No. 690 1 2 3, 1/4" Screwdriver bit PZ No. 690 PZD 1 2 3
 1/4" Screwdriver bit TX No. 687 TX T6 T7 T8 T9 T10 T15 T20 T25 T27 T30 T40, 1/4" Multi handle No. 676, 1/4" Bit holder No. 699
 1/2" Reversible ratchet No. 1993 U-20, 1/2" Extension No. 1990-2.1/2, 1/2" Cardan extension No. 1990 KR-5 -10
 1/2" Socket insert No. D 19 10 11 12 13 14 15 16 17 18 19 21 22 24 27 30 32, 1/2" Screwdriver socket in-hex No. IN 19 5 6 7 8 9 10 12 14
 Insert holder 1/4" hexagon - 1/4" square No. 673 6.3, Bit-Adapter 1/4" hexagon - 1/4" square No. 620
 Combination spanner UD-profile No. 7 8 9 10 11 12 13 14 15 16 17 18 19 20 21 22 24, Allen Key set No. PH 42-88 (2-10 mm)
 3C-Screwdriver slotted No. 2154SK 3.5 5.5 6.5 8, 3C-Screwdriver PH No. 2160SK PH 1 2, Universal pliers No. 142 10 TL, Power combination pliers No. 8250-180 JC
 Multiple pliers No. 8133-200 JC, Power side cutters No. 8316-180 JC, Engineer's hammer No. 4 E-500, Centre punch No. 100-12, Pin punch No. 119-1,5-3 -4
 Flat chisel No. 97-250, Cross-cut chisel No. 98-125, Drift punch No. 99 12-5, Twist drill set No. 8550-024

WHL-L7-TS-308 TROLLEY WORKSTER HIGHLINE WITH TOOL ASSORTMENT

308 pieces

- › Tool set in check tool modules (CT) for industry, trade and the automotive sector
- › Completeness check through 2-coloured foam inserts
- › Non-slip, with recessed grip
- › Resistant to oil and grease
- › Metric tool sizes
- › In tool trolley No. WHL-L7



Code	No.	Height mm	Width mm	Depth mm	Drawers	Number of drawers	Pieces	Weight kg
3082113	WHL-L7-TS-308	1.045	785	510	7 drawers: 5x Type 1, H = 80 mm 2x Type 2, H = 160 mm	7	308	112,6

Contents

1/4" Reversible ratchet No. 2093 U-20, 1/4" Wobble extension No. 2090 KR-4, 1/4" T-handle No. 2087
 1/4" Socket UD-profile No. D 20 4 5 5.5 6 7 8 9 10 11 12 13, 1/4" Socket insert No. TX 20 E4 E5 E6 E7 E8 E10
 1/4" Screwdriver bit slotted No. 680 4 5.5 6.5 8, 1/4" Screwdriver bit hex No. 685 2.5 3 4 5 6, 1/4" Screwdriver bit XZN No. 685 X 5 6 8
 1/4" Screwdriver bit PH No. 690 1 2 3, 1/4" Screwdriver bit PZ No. 690 PZD 1 2 3, 1/4" Screwdriver bit TX No. 687 TX T6 T7 T8 T9 T10 T15 T20 T25 T27 T30 T40
 1/4" Multi handle No. 676, 1/4" Bit holder No. 699, 1/2" Reversible ratchet No. 1993 U-20, 1/2" Extension No. 1990-2.1/2
 1/2" Wobble extension No. 1990 KR-5 -10, 1/2" Socket No. D 19 10 11 12 13 14 15 16 17 18 19 21 22 24 27 30 32
 1/2" Screwdriver socket in-hex No. IN 19 5 6 7 8 9 10 12 14, 1/2" Screwdriver socket XZN No. INX 19 6 8 10 12
 1/2" Screwdriver socket in-hex No. IN 19 L 5-90 6-90 8-90 10-140 12-140 14-140, long
 1/2" Screwdriver socket TX No. ITX 19 T20 T25 T27 T30 T40 T45 T50 T55 T60
 1/2" Screwdriver socket TX No. ITX 19 L T20-100 T25-100 T27-100 T30-100 T40-100 T45-100 T50-100 T55-100 T60-100, long
 1/2" Impact socket bit with protective sleeve No. K 19 LS 17 19 21, 5/16" Screwdriver bit slot No. 880 7 8 9 12 ST-40
 5/16" Screwdriver bit in-hex No. 885 5 6 8 10, 5/16" Screwdriver bit PH No. 890 1 2 3 4, 3/8" Reversible ratchet No. 3093 U-20 Recoilless hammer No. 248
 3/8" Cardan extension No. 3090 KR-5 -10, 3/8" Socket wrench UD-profile No. D 30 6 7 8 9 10 11 12 13 14 15 16 17 18 19 20 21 22 24
 3/8" Screwdriver socket in-hex No. IN 30 5 6 7 8 10, 3/8" Screwdriver socket XZN No. INX 30 5 6 8 10
 3/8" Screwdriver socket TX No. ITX 30 T20 T25 T27 T30 T40 T45 T50, Insert holder 1/4" hexagon - 1/4" square No. 673 6,3
 Bit-Adapter 1/4" hexagon - 1/4" square No. 620, Adaptor 5/16" hexagon - 1/2" square No. KB 819
 Open-end spanner with ring ratchet UD-profile No. 7 R 8 10 12 13 14 15 16 17 18 19
 Combination spanner UD-profile No. 7 8 9 10 11 12 13 14 15 16 17 18 19 20 21 22 24
 Double open-end spanner No. 6 6x7 8x9 10x11 12x13 14x15 16x17 18x19 20x22 24x27
 Double ring-end spanner UD-profile No. 2 6x7 8x9 10x11 12x13 14x15 16x17 18x19 20x22
 Double ring-end spanner hexagon No. 400 8x10 10x11 12x14 13x15 17x19, open
 Offset screwdriver set No. PH 42-88 (2-10 mm), Offset screwdriver set No. H 43 TX-09, 3C-Screwdriver slotted No. 2154SK 3.5 5.5 6.5 8
 3C-Screwdriver PH No. 2160SK PH 1 2, 3C-Screwdriver TX No. 2163 TX T10 T15 T20 T25 T30 T40
 Socket wrench with 3C handle hexagon No. 2133 5 5.5 6 7 8 9 10
 Universal pliers No. 142 10 TL, Power combination pliers No. 8250-180 JC, Multiple pliers No. 8133-200 JC
 Power side cutters No. 8316-180 JC, Circlip pliers for external retaining rings No. 8000 A 1 A 2 A 21
 Circlip pliers for internal retaining rings No. 8000 J 1 J 2 J 21, Engineer's hammer No. 4 E-500, Centre punch No. 100-12
 Pin punch No. 119-1,5 -3 -4, Flat chisel No. 97-250, Cross-cut chisel No. 98-125, Drift punch No. 99 12-5
 Twist drill set No. 8550-024, Hacksaw No. 407, Grip pliers 10" No. 137 10, Steel tape measure, 5m No. 4534-5
 Screw remover 1/2" No. K 1900, Cable knife No. 0063-08, Wire brush No. 646
 Pocket vernier caliper No. 710, Key file set No. 8728, Bolt extractor set No. 8551-55
 Gasket scraper No. 133 K, Feeler gauge set, fan pattern No. 702 20 M

ROBUST COMPANION

2004 0511 TOOL TROLLEY



- › Working platform in ABS, with compartments for small parts
- › Storage compartment with perforated sheet (Euro perforation 10 x 38 mm), two removable drawers for small parts and door on the handle side
- › Wide drawers (W 480 x D 400 mm) fully extendable, removable
- › Load capacity per drawer 40 kg, bottom heavy-duty drawer 60 kg
- › Total load capacity 1000 kg static (750 kg dynamic)
- › Even under maximum loads, the GEDORE axle design ensures: smooth running, maneuverability and directional stability

€1083,¹⁹
+ VAT



Code	No.	RAL	Width mm	Height mm	Depth mm	Drawers	Max. load-bearing capacity kg	Number of drawers	Crosswise divider	Lengthwise divider	Weight kg
1640739	2004 0511	RAL 5017	865	1.020	605	5x Type 1, H = 67 mm 1x Type 2, H = 137 mm 1x Type 3, H = 207 mm	1000	7	2	3	85

1500 ES-02-2004

TOOL TROLLEY WITH TOOL ASSORTMENT

207 pieces



- > High-performance tool trolley in proven GEDORE industrial quality with basic equipment for the commercial sector or the ambitious do-it-yourselfer
- > Metric tool sizes
- > Proven GEDORE ES tool modules in ABS plastic
- > Resistant to oil and grease

€2167,²³ + VAT

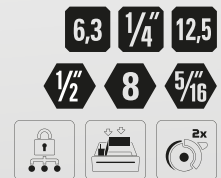

Code	No.	Width mm	Height mm	Depth mm	Pieces	Weight kg
2657708	1500 ES-02-2004	865	1.020	605	207	117,1

Contents

1/4" Reversible ratchet No. 2093 U-10, 1/4" T-handle No. 2087, 1/4" Extension No. 2090-4
 1/4" Universal Joint. 2095, 1/4" Square handle No. 2098
 1/4" Socket hexagon No. 20 4 5 5.5 6 7 8 9 10 11 12 13 14, 1/4" Socket TX No. TX 20 E4 E5 E6 E7 E8 E10
 1/4" Screwdriver socket in-hex No. IN 20 3 4 5 6 8, 1/4" Screwdriver socket TX No. ITX 20 T8 T9 T10 T15 T20 T25 T27 T30 T40
 1/2" Reversible ratchet No. 1993 U-20, 1/2" T-handle No. 1987, 1/2" Universal joint No. 1995, 1/2" Extension No. 1990-5-10
 1/2" Socket hexagon No. 19 10 11 12 13 14 15 16 17 18 19 21 22 23 24 26 27 28 30 32
 1/2" Screwdriver socket slotted No. IS 19 10x1,6 12x2, 1/2" Screwdriver socket cross-recess PH No. IKS 19 2 3 4
 1/2" Screwdriver socket XZN No. INX 19 8 10, 1/2" Screwdriver socket TX No. ITX 19 T20 T25 T27 T30 T40 T45 T50 T55 T60
 1/2" Screwdriver socket TX No. ITX 19 L T20-100 T25-100 T27-100 T30-100 T40-100 T45-100 T50-100 T55-100 T60-100, long
 1/2" Screwdriver socket in-hex No. IN 19 5 6 7 8 9 10 12 14 17
 1/2" Screwdriver socket in-hex No. IN 19 L 5-90 6-90 8-90 10-140 12-140 14-140, long
 1/2" Impact socket hexagon No. K 19 10 13 14 17 19, 1/2" Screw remover No. K 1900, 5/16" Screwdriver bit slotted No. 880 7 8 9 12
 5/16" Screwdriver bit in-hex No. 885 5 6 8 10, 5/16" Screwdriver bit PH No. 890 1 2 3 4, Adaptor 5/16" hexagon - 1/2" square No. KB 819
 Combination spanner UD-profile No. 1 B 6 7 8 9 10 11 12 13 14 15 16 17 18 19 20 21 22
 Open-end spanner with ring ratchet, UD-profile No. 7 R 8 10 12 13 14 15 16 17 18 19
 Double open-end spanner No. 6 6x7 8x9 10x11 12x13 14x15 16x17 18x19 20x22 21x23 24x27
 Allen Key set No. PH 42-88 (2-10 mm), Nut Driver No. 2133 5,5 6 7 8 9 10
 Universal pliers 10" 15 settings 2C-Handle No. 142 10 JC
 Power combination pliers 180 mm 2C-Handle No. 8250-180 JC
 Flat nose pliers 160 mm 2C-Handle No. 8132-160 JC
 Power side cutters 160 mm 2C-Handle No. 8316-160 JC, Centre punch No. 100-12
 Pin punch No. 119-1.5 -3 -4, Flat chisel No. 97-250
 Cross-cut chisel No. 98-125, Drift punch No. 99 12-5
 Engineers' hammer ROTBAND-PLUS No. 600 H-300
 Thread file metric No. 140, Steel tape measure 5m No. 4534-5
 Digital measuring calliper No. 711
 Tweezers with angled tips No. 720
 Scriber No. 745
 3C-Screwdriver slot No. 2150 4,5 5 6,5 8
 3C-Screwdriver slot No. 2160 PH 1 2
 Circlip pliers for external retaining rings, straight No. 8000 A 1 2
 Circlip pliers for external retaining rings, offset No. 8000 A 21
 Circlip pliers for external retaining rings, straight No. 8000 J 1 2
 Circlip pliers for external retaining rings, offset No. 8000 J 21
 TX Gauge No. 708 [2x]
 Distance module empty No. 1500 ED-70 K, 475x77x40 mm [6x]
 Tool trolley with 8 drawers No. 2004 0620

1500 ES-03 2004
**TOOL TROLLEY WITH TOOL
 ASSORTMENT**
 325 pieces



- > High-performance tool trolley in proven GEDORE industrial quality with extensive industrial range for professionals
- > Metric tool sizes
- > Proven GEDORE ES tool modules in ABS plastic



Code	No.	Width mm	Height mm	Depth mm	Pieces	Weight kg
2657716	1500 ES-03-2004	865	1.020	605	325	125,8

Contents

1/4" Reversible ratchet No. 2093 U-10, 1/4" T-handle No. 2087, 1/4" Extension No. 2090-4, 1/4" Universal joint No. 2095
 1/4" Square handle No. 2098, 1/4" Socket hexagon No. 20 4 5 5.5 6 7 8 9 10 11 12 13 14, 1/4" Socket No. 20 L 4.4 5.5 6 7 8 9 10 12 13, long
 1/4" Screwdriver socket in-hex No. IN 20 3 4 5 6 8, 1/4" Socket TX No. TX 20 E4 E5 E6 E7 E8 E10
 1/4" Screwdriver socket TX No. ITX 20 T8 T9 T10 T15 T20 T25 T27 T30 T40, 1/4" Screwdriver bit slotted No. 680 4 5.5 6.5 8
 1/4" Screwdriver bit in-hex No. 685 2.5 3 4 5 6, 1/4" Screwdriver bit in-hex No. 685 X 5 6 8
 1/4" Screwdriver bit in-hex No. 687 TX T6 T7 T8 T9 T10 T15 T20 T25 T27 T30 T40, 1/4" Screwdriver bit PH No. 690 1 2 3
 1/4" Screwdriver bit PZ No. 690 PZD 1 2 3, 1/4" Bit holder No. 699, 1/4" Bit holder No. 620, 1/4" Multi handle No. 676
 1/2" Reversible ratchet No. 1993 U-20, 1/2" T-handle No. 1987, 1/2" Universal joint No. 1995, 1/2" Extension No. 1990-5 -10
 1/2" Socket hexagon No. 19 10 11 12 13 14 15 16 17 18 19 21 22 23 24 26 27 28 30 32
 1/2" Socket hexagon No. IS 19 10x1.6 12x2, 1/2" Socket hexagon No. IKS 19 2 3 4
 1/2" Screwdriver socket in-hex No. IN 19 5 6 7 8 9 10 12 14 17, 1/2" Screwdriver socket in-hex No. IN 19 L 5-90 6-90 8-90 10-140 12-140 14-140, long
 1/2" Screwdriver socket TX No. ITX 19 T20 T25 T27 T30 T40 T45 T50 T55 T60
 1/2" Screwdriver socket TX No. ITX 19 L T20-100 T25-100 T27-100 T30-100 T40-100 T45-100 T50-100 T55-100 T60-100, long
 1/2" Screwdriver socket XZN No. INX 19 8 10, 1/2" Impact socket hexagon No. K 19 10 13 14 17 19, 1/2" Screw remover No. K 1900
 5/16" Screwdriver bit slotted No. 880 7 8 9 12, 5/16" Screwdriver bit in-hex No. 885 5 6 8 10
 5/16" Screwdriver bit cross-head PH No. 890 1 2 3 4, Adaptor 5/16" hexagon - 1/2" square No. KB 819
 Insert holder 1/4" hexagon - 1/4" square No. 673 6.3, Combination holding tool No. 639, Adjustable open-end wrench No. 60 P 8 10"
 Combination spanner UD-profile No. 1 B 6 7 8 9 10 11 12 13 14 15 16 17 18 19 20 21 22
 Open-end spanner with ring ratchet UD-profile No. 7 R 8 10 12 13 14 15 16 17 18 19
 Double ring-end spanner UD-profile No. 2 6x7 8x9 10x11 12x13 14x15 16x17 18x19 20x22
 Double ended flare nut spanner No. 400 8x10 10x11 12x14 13x15 17x19
 Double ring-end spanner No. 6 6x7 8x9 10x11 12x13 14x15 16x17 18x19 20x22 21x23 24x27
 Double-ended spanner UD-profile No. 34 8x9 10x11 12x13 14x15 16x17, 3C-Screwdriver slotted No. 2150 4 5.5 6.5 8
 3C Screwdriver slotted No. 2160 PH 1 2, 3C-Screwdriver TX No. 2163 TX T8 T10 T15 T20 T25 T30
 VDE Screwdriver slotted No. VDE 2170 4 5.5 6.5 8, VDE Screwdriver PZ No. VDE 2160 PZ 1 2, Offset screwdriver No. DT 2142 2 2.5 3 4 5 6 7 8 10
 Offset screwdriver set in holder 8pcs No. PH 42-88 (2 2.5 3 4 5 6 8 10), Allen key set No. H 42 KEL-88, hexagon 2.2 5 3 4 5 6 8 10 mm, ball end
 Offset screwdriver set TX No. H 43 KTX-07, TX T10 T15 T20 T25 T27 T30 T40, Bolt extractor set No. 8551-55, M3-M18
 Universal pliers 10", 15 settings No. 142 10 C, VDE Power combination pliers No. VDE 8250-180 H, VDE Flat nose pliers No. VDE 8132-160 H
 VDE Side cutter No. VDE 8314-160 H, Voltage tester slotted No. 4615 3, 220-250 V, 3mm
 Circlip pliers for external retaining rings, straight No. 8000 A 1 2, Circlip pliers for external retaining rings, offset No. 8000 A 21
 Circlip pliers for internal retaining rings, straight No. 8000 J 1 2, Circlip pliers for internal retaining rings, offset No. 8000 J 21
 Grip pliers No. 137 10, Centre punch No. 100-12, Pin punch No. 119-1, 5 -3 -4, Flat chisel No. 97-250, Cross-cut chisel No. 98-125, Drift punch No. 99 12-5
 Scraper No. 133 K, Engineers' hammer ROTBAND-PLUS No. 600 H-300, Thread file metric No. 140, Steel tape measure 5m No. 4534-5
 TX Gauge No. 708 (2X), Digital measuring calliper No. 711, Tweezers with angled tips No. 720, Scriber No. 745
 Key file set No. 8728 Flat butt, 3-edge, 4-edge, half-round, round file
 Cable knife No. 0513-09, 195 mm, Cross-beam 2-arm No. 106/103
 Cross-beam 3-arm No. 107/103, Spindle No. 1.1406140, Pulling leg No. 106/S100-E [3x], Miniature LED light No. 649
 Distance module empty No. 1500 ED-70 K, 475x77x40 mm [7x], Tool trolley with 9 drawers No. 2004 0810

2005 0701
TOOL
TROLLEY

€1128,⁵⁷
+ VAT



- › ABS worktop with small part compartments
- › Side walls with Euro perforation 10 x 38 mm
- › Added safety due to heel protection and edge protection
- › Wide drawers (W 640 x D 400 mm) fully extendable, removable
- › Load capacity per drawer 40 kg, bottom heavy-duty drawer 60 kg
- › Total load capacity 1000 kg static (750 kg dynamic)



Code	No.	RAL	Width mm	Height mm	Depth mm	Drawers	Max. load-bearing capacity kg	Number of drawers	Crosswise divider	Lengthwise divider	Weight kg
2003554	2005 0701	GEDORE blue, RAL 5017	865	1.020	605	7x Type 1, H = 67 mm 1x Type 3, H = 207 mm	1000	8	2	3	87

2005-TS-147
TOOL TROLLEY WITH TOOL
ASSORTMENT

147 pieces

- › Tools in metric dimensions for industry, trade, automotive
- › In Check-Tool-Modules



€1621,⁰¹
+ VAT

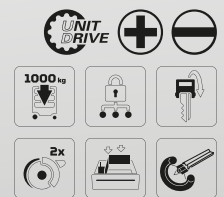

Code	No.	Width mm	Height mm	Depth mm	Pieces	Weight kg
2980282	2005-TS-147	865	1.020	605	147	104,3

Contents

1/4" Reversible ratchet No. 2093 U-20, 1/4" Wobble extension No. 2090 KR-4, 1/4" T-handle No. 2087
 1/4" Socket UD-profile No. D 20 4 5 5.5 6 7 8 9 10 11 12 13, 1/4" Socket insert No. TX 20 E4 E5 E6 E7 E8 E10
 1/4" Screwdriver bit slotted No. 680 4 5.5 6 5.8, 1/4" Screwdriver bit in-hex No. 685 2.5 3 4 5 6, 1/4" Screwdriver bit XZN No. 685 X 5 6 8
 1/4" Screwdriver bit PH No. 690 1 2 3, 1/4" Screwdriver bit PZ No. 690 PZD 1 2 3, 1/4" Screwdriver bit TX No. 687 TX T6 T7 T8 T9 T10 T15 T20 T25 T27 T30 T40
 1/4" Multi handle No. 676, 1/4" Bit holder No. 699, 1/2" Reversible ratchet No. 1993 U-20, 1/2" Extension No. 1990-2.1/2, 1/2" Wobble extension No. 1990 KR-5 -10
 1/2" Socket No. D 19 10 11 12 13 14 15 16 17 18 19 21 22 24 27 30 32, 1/2" Screwdriver socket in-hex No. IN 19 5 6 7 8 9 10 12 14
 Insert holder 1/4" hexagon - 1/4" square No. 673 6.3, Bit-Adapter 1/4" hexagon - 1/4" square No. 620
 Combination spanner UD-profile No. 7 8 9 10 11 12 13 14 15 16 17 18 19 20 21 22 24, Allen Key set No. PH 42-88 (2-10 mm)
 3C-Screwdriver slotted No. 2154SK 3.5 5.5 6.5 8, 3C-Screwdriver PH No. 2160SK PH 1 2, Universal pliers No. 142 10 TL
 Power combination pliers No. 8250-180 JC, Multiple pliers No. 8133-200 JC, Power side cutters No. 8316-180 JC
 Engineer's hammer No. 4 E-500, Centre punch No. 100-12, Pin punch No. 119-1,5 -3 -4
 Flat chisel No. 97-250, Cross-cut chisel No. 98-125
 Drift punch No. 99 12-5, Twist drill set No. 8550-024

2005-TS-190
**TOOL TROLLEY WITH TOOL
 ASSORTMENT**
 190 pieces

- › Tools in metric dimensions for industry, trade, automotive
- › In Check-Tool-Modules



Code	No.	Width mm	Height mm	Depth mm	Pieces	Weight kg
2980290	2005-TS-190	865	1.020	605	190	109,6

Contents

- 1/4" Reversible ratchet No. 2093 U-20, 1/4" Wobble extension No. 2090 KR-4
- 1/4" T-handle No. 2087, 1/4" Socket UD-profile No. D 20 4 5 5.5 6 7 8 9 10 11 12 13
- 1/4" Socket No. TX 20 E4 E5 E6 E7 E8 E10, 1/4" Screwdriver bit slotted No. 680 4 5.5 6,5 8
- 1/4" Screwdriver bit in-hex No. 685 2.5 3 4 5 6
- 1/4" Screwdriver bit XZN No. 685 X 5 6 8
- 1/4" Screwdriver bit PH No. 690 1 2 3
- 1/4" Screwdriver bit PZ No. 690 PZD 1 2 3
- 1/4" Screwdriver bit TX No. 687 TX T6 T7 T8 T9 T10 T15 T20 T25 T27 T30 T40
- 1/4" Multi handle No. 676, 1/4" Bit holder No. 699
- 1/2" Reversible ratchet No. 1993 U-20, 1/2" Extension No. 1990-2.1/2
- 1/2" Wobble extension No. 1990 KR-5 -10
- 1/2" Socket No. D 19 10 11 12 13 14 15 16 17 18 19 21 22 24 27 30 32
- 1/2" Screwdriver socket in-hex No. IN 19 5 6 7 8 9 10 12 14
- 1/2" Screwdriver socket XZN No. INX 19 6 8 10 12
- 1/2" Screwdriver socket in-hex No. IN 19 L 5-90 6-90 8-90 10-140 12-140 14-140, long
- 1/2" Screwdriver socket TX No. ITX 19 T20 T25 T27 T30 T40 T45 T50 T55 T60
- 1/2" Screwdriver socket TX No. ITX 19 L T20-100 T25-100 T27-100 T30-100 T40-100 T45-100 T50-100 T55-100 T60-100, long
- Insert holder 1/4" hexagon - 1/4" square No. 673 6.3
- Bit-Adapter 1/4" hexagon - 1/4" square No. 620
- Combination spanner UD-profile No. 7 8 9 10 11 12 13 14 15 16 17 18 19 20 21 22 24
- Double open-end spanner No. 6 6x7 8x9 10x11 12x13 14x15 16x17 18x19 20x22 24x27
- Allen key set No. PH 42-88 (2-10 mm)
- 3C Screwdriver slotted No. 2154SK 3.5 5.5 6.5 8
- 3C Screwdriver PH No. 2160SK PH 1 2
- Universal pliers No. 142 10 TL
- Power combination pliers No. 8250-180 JC
- Multiple pliers No. 8133-200 JC
- Power side cutters No. 8316-180 JC
- Circlip pliers for external retaining rings No. 8000 A 1 A 2 A 21
- Circlip pliers for internal retaining rings No. 8000 J 1 J 2 J 21
- Engineer's hammer No. 4 E-500
- Centre punch No. 100-12, Pin punch No. 119-1.5 -3 -4
- Flat chisel No. 97-250, Cross-cut chisel No. 98-125
- Drift punch No. 99 12-5, Twist drill set No. 8550-024

2005-TS-308 TOOL TROLLEY WITH TOOL ASSORTMENT

308 pieces

- Tools in metric dimensions for industry, trade, automotive
- In Check-Tool-Modules



Code	No.	Width mm	Height mm	Depth mm	Pieces	Weight kg
2980304	2005-TS-308	865	1.020	605	308	121,6

Contents

1/4" Reversible ratchet No. 2093 U-20, 1/4" Wobble extension No. 2090 KR-4, 1/4" T-handle No. 2087
 1/4" Socket UD-profile No. D 20 4 5 5.5 6 7 8 9 10 11 12 13, 1/4" Socket insert No. TX 20 E4 E5 E6 E7 E8 E10
 1/4" Screwdriver bit slotted No. 680 4 5.5 6.5 8, 1/4" Screwdriver bit in-hex No. 685 2.5 3 4 5 6
 1/4" Screwdriver bit XZN No. 685 X 5 6 8, 1/4" Screwdriver bit PH No. 690 1 2 3
 1/4" Screwdriver bit PZ No. 690 PZD 1 2 3, 1/4" Screwdriver bit TX No. 687 TX T6 T7 T8 T9 T10 T15 T20 T25 T27 T30 T40
 1/4" Multi handle No. 676, 1/4" Bit holder No. 699, 1/2" Reversible ratchet No. 1993 U-20
 1/2" Extension No. 1990-2.1/2, 1/2" Wobble extension No. 1990 KR-5 -10
 1/2" Socket No. D 19 10 11 12 13 14 15 16 17 18 19 21 22 24 27 30 32
 1/2" Screwdriver socket in-hex No. IN 19 5 6 7 8 9 10 12 14, 1/2" Screwdriver socket XZN No. INX 19 6 8 10 12
 1/2" Screwdriver socket in-hex No. IN 19 L 5-90 6-90 8-90 10-140 12-140 14-140, long
 1/2" Screwdriver socket TX No. ITX 19 T20 T25 T27 T30 T40 T45 T50 T55 T60
 1/2" Screwdriver socket TX No. ITX 19 L T20-100 T25-100 T27-100 T30-100 T40-100 T45-100 T50-100 T55-100 T60-100, long
 1/2" Impact socket bit with protective sleeve No. K 19 LS 17 19 21, 5/16" Screwdriver bit slotted No. 880 7 8 9 12 ST-40
 5/16" Screwdriver bit in-hex No. 885 5 6 8 10, 5/16" Screwdriver bit PH No. 890 1 2 3 4
 3/8" Reversible ratchet No. 3093 U-20 Recoiless hammer No. 248, 3/8" Wobble extension No. 3090 KR-5 -10
 3/8" Socket wrench UD-profile No. D 30 6 7 8 9 10 11 12 13 14 15 16 17 18 19 20 21 22 24
 3/8" Screwdriver socket in-hex No. IN 30 5 6 7 8 10, 3/8" Screwdriver socket XZN No. INX 30 5 6 8 10
 3/8" Screwdriver socket TX No. ITX 30 T20 T25 T27 T30 T40 T45 T50 Insert holder 1/4" hexagon - 1/4" square No. 673 6.3
 Bit-Adapter 1/4" hexagon - 1/4" square No. 620, Adaptor 5/16" hexagon - 1/2" square No. KB 819
 Open-end spanner with ring ratchet UD-profile No. 7 R 8 10 12 13 14 15 16 17 18 19
 Combination spanner UD-profile No. 7 8 9 10 11 12 13 14 15 16 17 18 19 20 21 22 24
 Double open-end spanner No. 6 6x7 8x9 10x11 12x13 14x15 16x17 18x19 20x22 24x27
 Double ring-end spanner UD-profile No. 2 6x7 8x9 10x11 12x13 14x15 16x17 18x19 20x22
 Double flare end spanner hexagon No. 400 8x10 10x11 12x14 13x15 17x19, open, Allen key set No. PH 42-88 (2-10 mm)
 Offset screwdriver set No. H 43 TX-09, 3C-Screwdriver slotted No. 2154SK 3.5 5.5 6.5 8
 3C-Screwdriver PH No. 2160SK PH 1 2, 3C-Screwdriver TX No. 2163 TX T10 T15 T20 T25 T30 T40
 Socket wrench with 3C handle hexagon No. 2133 5.5 6 7 8 9 10, Universal pliers No. 142 10 TL
 Power combination pliers No. 8250-180 JC, Multiple pliers No. 8133-200 JC
 Power side cutters No. 8316-180 JC, Circlip pliers for external retaining rings No. 8000 A 1 A 2 A 21
 Circlip pliers for internal retaining rings No. 8000 J 1 J 2 J 21, Engineer's hammer No. 4 E-500
 Centre punch No. 100-12, Pin punch No. 119-1.5 -3 -4, Flat chisel No. 97-250, Cross-cut chisel No. 98-125, Drift punch No. 99 12-5
 Twist drill set No. 8550-024, Hacksaw No. 407, Grip pliers 10" No. 137 10, Steel tape measure, 5m No. 4534-5, Screw remover 1/2" No. K 1900
 Cable knife No. 0063-08, Wire brush No. 646, Pocket vernier calipe No. 710, Key file set No. 8728
 Bolt extractor set No. 8551-55, Gasket scraper No. 133 K, Feeler gauge set, fan pattern No. 702 20 M

TOOL TROLLEY WITH XXL ASSORTMENT

NEW

The full range of hand tools for automotive professionals.

The tool trolley with 466-piece automotive assortment KL-4998-400 from GEDORE is the perfect companion for safe and efficient working on cars. From torque

wrenches to socket wrench sets and impact sockets through to voltage testers – with the sturdy and durable hand tools of the XXL assortment you are best equipped for working in the garage. The tool is spread over 8 clear overview

Check-Tool inserts, which can be placed in the trolley individually depending on the requirements and area of use. Order at the workplace is therefore guaranteed and everything runs smoothly. The GEDORE workshop trolley 2005 0810 with 9 drawers included in the set and its stationary 1,000 kg and 750 kg mobile load capacity optimally rounds off the package with regard to mobility and order.



Tool trolley with 9 drawers incl. 466-piece automotive assortment – KL-4998-400

1 FULL EXTENSION DRAWERS FOR EASY ACCESS

2 STURDY AND DURABLE TOOL

3 MOBILE WORKSTATION AND TOOL STORAGE COMBINED

4 FULLY EQUIPPED TOOL TROLLEY WITH 466 PIECES



KL-4998-400 WORKSHOP TROLLEY WITH TOOL ASSORTMENT FOR CARS

- > Fully equipped workshop trolley for repair and maintenance work on cars
- > Very robust and durable tools
- > Mobile workstation and tool storage combined
- > Full-extension drawers for easy access
- > Easy visual completeness check due to 2-colored foam inserts



Code	No.	Contents	Width mm	Height mm	Depth mm	Pieces	Weight kg
3421147	KL-4998-400	<p>Drawer 1 1/4" - Assortment (double hexagon 4-13; hexagon long 4-13; TX T10-T40; TX E4-E10; TX PLUS IP10-IP30; TX PLUS EP6-EP12; IN 3-8 cross slotted PH1-PH3; slot 5.5-6.5 mm) Bit Box (32 piece) Extensive pliers assortment Hexagon L key kit (TX T9-40; IN 2-10) Grip wrench brake line (11 mm) Steel measuring tape (5 m) Magnetic lifter</p> <p>Drawer 2 3/8" - Assortment (hexagon 6-19; double hexagon long 10-19; TX T20-T50; TX E6-E14; IN 4-11; XZN M5-M10; TX PLUS IP40-IP60; TX PLUS EP10-EP20; Spark plug socket spanner 14 + 16 + 18) Voltage tester (6-48 Volt AC/DC) Torque wrench (3/8", 10-50 Nm) Digital calliper gauge Feeler gauge</p> <p>Drawer 3 1/2" - Assortment (hexagon 8-32; TX T27-T60; TX E10-E24; IN 5-17; XZN M5-M16; TX PLUS EP22-EP32) Torque wrench (1/4", 40-200 Nm)</p> <p>Drawer 4 Screwdriver assortment (hexagon 6-10; IN 3-8; cross slotted PH1-PH4; slot 4.5-8 mm; TX T10-T40) Univ. brake calliper hook pair</p> <p>Drawer 5 Extensive range of impact, lifting and machining tools (Files, hammers, drills, pry bars, chisels, driver, centre punch)</p> <p>Drawer 6 Special grip pliers Brake calliper brush Combination spanner (6-32)</p> <p>Drawer 7 Open end spanner with ring ratchet (8-19) Double ring spanner (6-24, TX E6-E24) Starter block spanner (11-17) Double ring spanner open (8-19)</p> <p>Drawer 8 1/2" Socket spanner (hexagon long 10-32; IN 6-14; TX T27-T60) Power in-hex socket with protective sleeve (17-22) Power in-hex socket (13-27) Stripping knife and universal combination pliers</p>	865	1.020	605	466	110

2005 EP
STAINLESS
STEEL PLATE

€98,³²
+ VAT



- › Insert for the plastic cover of the tool trolley no. 2004 and 2005 as well as tool chest no. 2430
- › Made of stainless steel
- › Easy to remove and clean

Code	No.	Width mm	Depth mm	Weight kg
3419339	2005 EP	610	435	2,201

2005 HP
WOOD PLATE

€54,¹⁹
+ VAT



- › To be inserted into the plastic lid to obtain a flat working surface
- › Made of multiplex beech plywood
- › Suitable for tool trolleys 2004 and 2005 and tool chest 2430
- › No. 2004 HP until year of construction 03/2014 for depth 435 mm, No. 2004 HP-14 from year of construction 04/2014, for depth 475 mm
- › No. 2005 HP from year of construction 04/2022, for depth 440mm

Code	No.	Width mm	Height mm	Depth mm	Weight kg
3419320	2005 HP	615	30	440	4,5

411-125
PARALLEL VICE



- › Sturdy forged design
- › Protected vice spindle
- › Adjustable guidance

€197,⁴⁸
+ VAT

Code	No.	Jaw width mm	Usable clamping reach mm	Weight kg
6501100	411-125	125	150	12,4

2430 TOOL CHEST

€541,¹⁸
+ VAT



- › Working platform in ABS, with compartments for small parts
- › Central locking with cylinder lock
- › Wide drawers (W 640 x D 400 x H 67 mm) fully extendable, removable
- › Each drawer with safety locking, single-hand operation
- › Load capacity per drawer 40 kg



Code	No.	Height mm	Width mm	Depth mm	Lengthwise divider	Crosswise divider	Weight kg
1888927	2430	345	775	475	3	2	34

RT 2004 L REAR PANEL BOARD

€133,⁶¹
+ VAT



- › Can be attached to 2004 and 2005 (as well as old models 2002 and 2003)
- › Square holes 10 x 38 mm for tool hooks and holders No. 1500 H

Code	No.	Width mm	Height mm	Depth mm	Weight kg
2663104	RT 2004 L	765	715	30	11

1500 H 25-8 SPRAY CAN HOLDER

for 8 spray cans

€49,⁷⁴
+ VAT



- › Compatible with standard Euro square perforation 10 x 38 mm
- › Can also be used as transport box due to removable dividers
- › With carrying handle
- › Front square perforation for additional hooks (not included)

Code	No.	Width mm	Height mm	Depth mm	Weight kg
3127907	1500 H 25-8	315	100	165	2,05

1500 H 40 PAPER ROLL HOLDER

€31,⁶⁷
+ VAT



- › For paper rolls up to diameter 320 mm and width 320 mm
- › Lateral perforation for additional hooks (not included in delivery)
- › Colour RAL 9005 black
- › Suitable for all tool trolleys/benches with Euro holes 10 x 38 mm

Code	No.	Width mm	Depth mm	Weight kg
2997754	1500 H 40	350	200	1,1

NEW

XL TOOL TROLLEY WITH XXL ASSORTMENT

Whatever the screw connections required on a car, with this assortment you're best equipped for every event.

The tool trolley with 466-piece automotive assortment 2005 XL-S-466 from GEDORE is simply perfect for

efficient working on cars. The selection of tools leaves you wanting for nothing. From torque wrench to hammer through to pliers, everything required for automotive work is right here. The

assortment meets the highest demands, as is extremely sturdy and durable. With this selection of tools the tool trolley serves as both a mobile workstation and as tool storage. The tool you need is therefore immediately at hand at all times. The full extension of the 7 filled drawers means the tools are always easy to access.

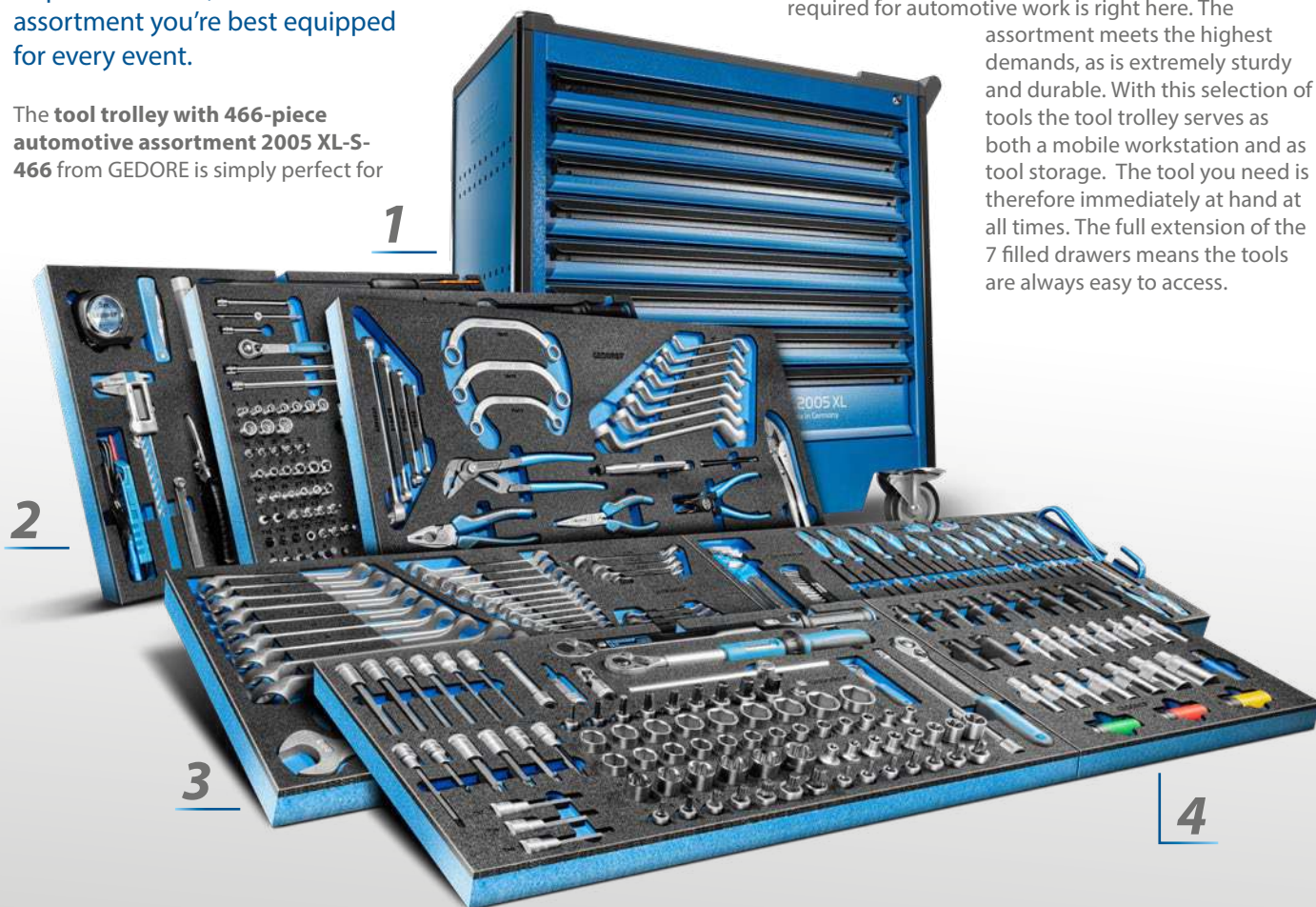

Tool trolley incl. 466-piece automotive assortment – 2005 XL-S-466

1

FULLY EQUIPPED
TOOL TROLLEY
WITH 466 PIECES

2

STURDY AND
DURABLE TOOL

3

MOBILE WORKSTATION
AND TOOL STORAGE
COMBINED

4

FULL EXTENSION DRAWERS
FOR EASY ACCESS



MAXIMUM
CONFIGURATION

2005 XL-5-466

TOOL TROLLEY WITH TOOL ASSORTMENT FOR CARS

466 pieces

- > Fully equipped tool trolley for repair and maintenance work on cars
- > Very robust and durable tools
- > Mobile workstation and tool storage combined
- > Full-extension drawers for easy access
- > Easy visual completeness check due to 2-colored foam inserts



Code	No.	Height mm	Width mm	Depth mm	Pieces	Weight kg
3458946	2005 XL-S-466	1.020	1.021	605	466	165,8

Contents

Extension No. 2090-2 -4 -6 -12, Universal joint No. 2095, Sliding T-bar 1/4" No. 2087, Ratchet with T-handle 1/4" No. 2093 U-3 T
 Reversible ratchet 1/4" No. 2093 U-20, Socket 1/4" No. D 20 4 5 6 7 8 9 10 11 12 13 mm, Socket 1/4", long No. 20 L 4 5 6 7 8 9 10 11 12 13 mm
 Socket 1/4" No. TX 20 E4 E5 E6 E7 E8 E10, Screwdriver bit socket 1/4" No. IKS 20 PH1 PH2 PH3, Screwdriver bit socket 1/4" No. IS 20 5,5x1 6,5x1,2
 Screwdriver bit socket 1/4" No. IN 20 3 4 5 6 8, Screwdriver bit socket 1/4" No. ITX 20 T10 T15 T20 T25 T27 T30 T40
 Socket 1/4" No. KL-4043-1106 -1107 -1108 -1110 -1111 -1112, Socket wrench 1/4" No. KL-4043-1010 -1015-1025 -1030, Socket wrench 1/4" No. KL-4043-1020
 Extension 3/8" No. 3090-5 -10 -12, Extension 3/8" with magnet No. 3090 M, Universal joint 3/8" No. 3095, Adaptor 3/8" to 1/2" No. 3019
 Reducer 3/8" to 1/4" No. 3020, Reversible ratchet 3/8" No. 3093 U-20, Swivel head reversible ratchet 3/8" No. 3093 GU-3
 Socket 3/8" No. 30 6 7 8 9 10 11 12 13 14 15 16 17 18 19, Socket 3/8", long No. D 30 L 10 11 12 13 14 15 16 17 18 19, Socket 3/8" No. TX 30 E6 E7 E8 E10 E11 E12 E14
 Screwdriver bit socket 3/8" No. IN 30 4 5 6 7 8 10, Screwdriver bit socket 3/8", long No. IN 30 4 5 6 7 8 10
 Screwdriver bit socket 3/8" No. KL-4021-3107 A -3109 A -3111 A, Screwdriver bit socket 3/8" No. ITX 30 T20 T25 T27 T30 T40 T45 T50
 Screwdriver bit socket 3/8", long No. ITX 30 L T20 T25 T27 T30 T40 T45 T50, Screwdriver bit socket 3/8" XZN No. INX 30 5 6 8 10
 Screwdriver bit socket 3/8", long XZN No. 6 8 10, Socket 3/8" No. KL-4043-2110 -2112 -2114 -2116 -2118 -2120, Socket wrench 3/8" No. KL-4043 IP40 IP45 IP50 IP55 IP60
 Extension 1/2" No. 1990-5 -10, Extension 1/2" with magnet No. 1990 M, Universal joint 1/2" No. 1995, Reducer 1/2" to 3/8" No. 1930, Sliding T bar 1/2" No. 1987
 Reversible ratchet 1/2" No. 1993 U-20, Telescopic reversible ratchet 1/2" No. 1993 TU-10, Socket 1/2" No. 8 9 10 11 12 13 14 15 16 17 18 19 20 21 22 23 24 26 27 28 30 32
 Socket 1/2" No. D 19 L 10 12 13 14 15 16 17 18 19 21 22 24 27 30 23, Socket 1/2" No. TX 19 E10 E11 E12 E14 E16 E18 E20 E24
 Screwdriver bit socket 1/2" No. IN 19 5 6 7 8 9 10 12 14 17, Screwdriver bit socket 1/2" TX No. ITX 19 T27 T30 T40 T45 T50 T55 T60
 Screwdriver bit socket 1/2" XZN No. INX 19 5 6 8 10 12 14 16, Screwdriver bit socket 1/2", long No. IN 19 L 5-90 6-140 7-140 8-140 9-140 10-140 12-140 14-140
 Screwdriver bit socket 1/2" No. ITX 19 L T27-100 T30-100 T40-100 T45-100 T50-100 T55-100 T60-100
 Socket 1/2" No. KL-4043-3122 -3124 -3126 -3128 -3130 -3132, Impact socket 1/2" with protective sleeve No. K 19 LS 17 19 21 22
 Impact socket 1/2", long No. K 19 L 13 14 16 17 18 19 21 22 23 24 27, Ratchet screwdriver SilentGEAR No. 2675, Insert holder short 1/4" No. 673 K
 Bit-Box Industry 32 pieces No. 666-032-J, Bit-Adapter 1/4" hexagon - 1/4" square No. 620
 Combination spanner No. 1 B 6 7 8 9 10 11 12 13 14 15 16 17 18 19 20 21 22 24 27 28 30 32
 Combination ratchet spanner No. 7 R 8 9 10 11 12 13 14 15 16 17 18 19, Double ring-end spanner No. 2 6x7 8x9 10x11 12x13 14x15 16x17 18x19 22x24
 Double ring-end spanner No. TX 4 E6xE8 E10xE12 E14xE18 E20xE24, Double flare end spanner, open No. 400 8x10 11x13 12x14 17x19
 Half-moon ring spanner No. 304 11x13 14x16 15x17, Nut driver No. 2133 6 7 8 9 10, 3C-Screwdriver, short No. 2153 5,5
 3C-Screwdriver with striking cap No. 2154SK 4,5 5,5 6,5 8, 3C-Screwdriver with striking cap No. 2160SK PH1 PH2 PH3 PH4
 3C-Screwdriver, short No. 2161 PH1, 3C-Screwdriver No. 2163 TXB T10 T15 T20 T25 T27 T30 T40, 3C-Screwdriver ball end No. 2163 K 3 4 5 6 8
 Allen key set 2-10 mm No. H 42 KEL-88, Hexagon socket key set TX T9-T40 No. H 43 TX-88, Voltage tester 6-48 Volt AC/DC No. 4612
 Power combination pliers No. 8250-180 JC, Side cutter No. 8314-180 JC, Multiple pliers No. 8133-180 JC, Telephone plier No. 8132 AB-160 JC
 Universal pliers 10" No. 142 10 TL, Set of circlip pliers 4 pieces No. S 8000, Universal combination shears No. KL-4901-10, Cable knife No. 0063-08
 Grip wrench No. 137 7-11, Steel tape measure No. 4534-5, Digital measuring calliper No. 711, Feeler Gauge No. 702 20 M, Magnetic lifter No. KL-0126-206
 Torque wrench UK Torcoflex No. 3549-05 10-50 Nm, Torque wrench UK Torcoflex No. 3550-20 40-200 Nm
 Universal Brake Calliper Hook No. KL-0114-550, Brake caliper file No. 8726, Brake calliper brush No. 643
 Spark plug socket spanner with joint No. KL-0127-48, Spark plug insert with retaining spring No. 53 16 mm
 Spark plug insert with retaining spring No. 56 18 mm, Gasket scraper No. 133 K
 Hand file No. 8701 2-10, half round file No. 8725 2-10, Round file No. 8722 2-10, Flat chisel No. 97-125 -150 -200
 Cross cut chisel, flat oval No. 96-150, Drift punch No. 99 10-2 -3 -4, Centre punch No. 100-10
 Pin punch No. 119 3 4 5 6, Engineer's hammer ROTBAND-PLUS No. 600 E-400 -1500
 Recoilless hammer No. 248 H-30, Twist drill bit set No. R93500025 Ø1-13, Prybar No. 141-300 -390
 Special grip wrench No. 139, Bottle opener 2C GEDORE No. GMH990007

NEW

TOOL TROLLEY 2005 XL WITH 25% EXTRA SPACE

There's really not much more to say about the GEDORE tool trolley 2005 – except that this true classic now comes in another XL version. With all the benefits and features of a mobile workstation, such as high total load capacity combined with 25% more volume, spread over 7 extra-wide drawers.

The GEDORE **tool trolley 2005 XL 0520** is THE solution when the mobility and manoeuvrability of a workshop trolley and the big storage space of a workbench are required. At 792 mm, the 7 drawers of the 2005 XL are a full 152 mm wider than the standard model's – 25% extra drawer volume. The load (maximum 1,000 kg in stationary use, 750 kg in mobile use) is carried easily and problem-free by the drawers running on ball bearing guide rails and the chassis with trapezoidal axle structure. 6 of the drawers provide a load capacity of 60 kg and the bottom heavy-duty drawer provides 70 kg load capacity. Even at full load the 2005 XL is still easy to manoeuvre, and runs smoothly and directionally stable. An extra-wide shelf surface also turns the workshop trolley into a workbench.



Tool trolley – 2005 XL 0520

1

**7 EXTRA-WIDE
DRAWERS**

2

**HIGH TOTAL LOAD
CAPACITY - 1,000 KG**

3

**EASY TO
MANOEUVRE**

4

**MULTIFUNCTIONAL,
EXTRA-WIDE
SHELF/MOUNTING SURFACE**



2005 XL
TOOL TROLLEY
with 7 drawers



- > 7 extra wide drawers with large storage space
- > Multifunctional, extra wide storage/mounting surface
- > 1,000 kg total load capacity (static), 6 drawers at 60 kg each, one heavy-duty drawer at 70kg
- > Full-extension drawers for easy access
- > Special GEDORE chassis for smooth running, manoeuvrability and directional stability under maximum load
- > Compatible with GEDORE tool sets (ES or CT modules) for different applications



Code	No.	RAL	Width mm	Height mm	Depth mm	Drawers	Max. load-bearing capacity kg	Number of drawers	Crosswise divider	Lengthwise divider	Weight kg	excl. VAT.
3437493	2005 XL 0520	GEDORE blue, RAL 5017	1.021	1.020	605	5x Typ1, H. = 71 mm 2x Typ2, H. = 146 mm	1000	7	2	3	105,5	1402,52
3437523	2005 XL 0330	GEDORE blue, RAL 5017	1.021	1.020	605	3x Typ1, H. = 71 mm 3x Typ2, H. = 146 mm	1000	6	2	3	97	1310,08

TTB 0321
TOOL TROLLEY
with 6 drawers



- > Compact tool trolley with 6 drawers and plenty of storage space
- > The total load capacity is 900 kg (static) and 650 kg (dynamic)
- > Wide drawers (W 640 x D 400 mm) with central locking and cylinder lock
- > Thanks to ball-bearing guide rails with full telescopic extension, the entire drawer can be accessed
- > Two heavy-duty wheels with roller bearings and two light-duty wheels with ball bearings and total locking device
- > Large usable storage space with shelf and door

€811,76
+ VAT

Code	No.	Width mm	Height mm	Depth mm	Drawers	Max. load-bearing capacity kg	Number of drawers	Weight kg
3411435	TTB 0321	775	985	475	3x Type1, H. = 67 mm 2x Type2, H. = 137 mm 1x Type3, H. = 207 mm	900	6	78

TTB-TS-173
**TOOL TROLLEY
 WITH ASSORTMENT**
 173 pieces



- › Compact tool trolley with versatile tool set, as basic equipment for the workshop
- › The total load capacity is 900 kg (static) and 650 kg (dynamic)
- › Intelligent product selection from which the torsion bit set, a 1/4" bit socket box and multiple pliers stand out
- › The torsion bit set with torsion bits, sockets and much more for demanding and diverse screw connections
- › Bit socket wrench box including the premium quality ratchet with a low swing-back angle of 6° for hard-to-reach places
- › The multiple pliers are perfect for holding, bending, cutting, stripping, crimping and squeezing



Code	No.	Height mm	Width mm	Depth mm	Pieces	Weight kg
3411443	TTB-TS-173	985	775	475	173	90,7
	Contents					
	1993 U-20 Reversible ratchet 1/2"					
	1990-3 Extension					
	1990-5 Extension					
	1990-10 Extension					
	D 19 10 12 13 15 16 17 18 19 22 24 27 30 32					
	IN 19 5 6 7 8 9 10 12 14 17 19					
	666- U-20 Bit socket box with ratchet 1/4"					
	1990 M Extension 1/2" with holding magnet					
	1 B 8 10 11 12 13 14 15 16 17 18 19 21 22 24 27 30 32					
	666-042					
	2150 4 3C-Screwdriver slotted 4x0, 8x100mm					
	2150 5,5 3C-Screwdriver slotted 5,5x1x100mm					
	2150 6,5 3C-Screwdriver slotted 6,5x1, 2x150mm					
	2150 8 3C-Screwdriver slotted 8x1, 2x150mm					
	2160 PH 1 Screwdriver					
	2160 PH 2 Screwdriver					
	142 10TL Universal pliers					
	8133-200 JC Multiple pliers					
	8314-180 JC Side cutters					
	4615 3 Test screwdriver					
	4 E-500 Locksmith's hammer					
	8550-024 Twist Drill- Set 24-piece					
	316 D Pin punch set in metal hinged case					
	H 42-10 Angle screwdriver set					
	LW EI-TS CT4-1B-19 CT insert empty					
	LW EI-TS CT4-2150-142 CT insert empty					
	Tool trolley with 6 drawers					

1504 0701
MOBILE WORKBENCH



- › 30 mm thick multiplex beech wood worktop, surface additionally protected by linseed oil varnish
- › Large usable storage space with shelf and door
- › Wide drawers (W 480 x D 400 mm) fully extendable, removable
- › Load capacity per drawer 40 kg, bottom heavy-duty drawer 60 kg
- › GEDORE high-performance running gear, total load capacity 1000 kg, in mobile operation 750 kg
- › The GEDORE trapezoidal axle construction secures smooth running, manoeuvrability and track-keeping also in case of maximum loads

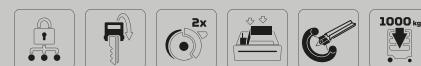

Code	No.	Height mm	Width mm	Depth mm	Worktop thickness mm	Drawers	Number of drawers	Weight kg
1814931	1504 0701	985	1.100	630	30	7x Type 1, H = 67 mm 1x Type 3, H = 207 mm	8	105

BR 1504 0511 LH
MOBILE
WORKBENCH



- › 30 mm thick multiplex beech wood worktop, surface additionally protected by linseed oil varnish
- › Large usable storage space with shelf and door
- › With rear panel, square perforation 10 x 38 mm to fix hooks and tools, with lowering mechanism, can be raised by 2 gas springs
- › Wide drawers (W 480 x D 400 mm) fully extendable, removable
- › Load capacity per drawer 40 kg, bottom heavy-duty drawer 60 kg
- › Total load capacity 1000 kg, 750 kg when mobile



Code	No.	Width mm	Height mm	Depth mm	Worktop thickness mm	Drawers	Number of drawers	Weight kg
6623990	BR 1504 0511 LH	1.100	1.625	665	30	5x Type 1, H = 67 mm 1x Type 2, H = 137 mm 1x Type 3, H = 207 mm	7	130

1504 XL 1710 MOBILE WORKBENCH EXTRA-WIDE



- > 30 mm thick multiplex beech wood worktop, surface additionally protected by linseed oil varnish
- > Large usable storage space with shelf and door
- > 1 XL drawer (W 1055 x D 400), 8 wide drawers (W 640 x D 400 mm) fully extendable, removable
- > Load capacity per drawer 40 kg, bottom heavy-duty drawer 60 kg
- > Total load capacity 1000 kg, 750 kg when mobile
- > The GEDORE trapezoidal axle construction secures smooth running, manoeuvrability and track-keeping also in case of maximum loads



Code	No.	Height mm	Width mm	Depth mm	Worktop thickness mm	Drawers	Number of drawers	Weight kg
2259001	1504 XL 1710	985	1.250	630	30	5x Type 1, H = 67 mm 1x Type 2, H = 137 mm 1x Type 3, H = 207 mm	9	126,5

1505 MOBILE WORKBENCH



- > 40 mm thick multiplex beech plywood board, surface additionally protected by linseed oil varnish
- > Easy, safe movement with pull handle
- > 5 wide drawers (W 480 x D 550 mm) with partial extension (505 mm), removable
- > Load capacity per drawer 40 kg
- > Total load capacity 2000 kg, 500 kg when mobile
- > Absolutely stable standing when lowered

€2074,79 + VAT



Code	No.	Height mm	Width mm	Depth mm	Worktop thickness mm	Drawers	Number of drawers	Weight kg
6621780	1505	900	1.100	650	40	3x Type 1, H = 79 mm 1x Type 2, H = 160 mm 1x Type 3, H = 180 mm	5	139

1506 XL 2511 MOBILE WORKBENCH EXTRA-WIDE



- > 30 mm thick multiplex beech wood worktop, surface additionally protected by linseed oil varnish
- > Wide drawers (W 480 x D 400 mm) fully extendable, removable
- > Load capacity per drawer 40 kg, bottom heavy-duty drawer 60 kg
- > Total load capacity 1000 kg, 750 kg when mobile
- > The GEDORE trapezoidal axle construction secures smooth running, manoeuvrability and track-keeping also in case of maximum loads



Code	No.	Height mm	Width mm	Depth mm	Worktop thickness mm	Drawers	Number of drawers	Weight kg
2528088	1506 XL 2511	985	1.250	630	30	10x Type 1, H = 67 mm 2x Type 2, H = 137 mm 2x Type 3, H = 207 mm	14	141

BR 1500 LH WORKBENCH WITH TOOL CABINET



- > 40 mm thick multiplex beech plywood board, surface additionally protected by linseed oil varnish
- > Large storage space with shutter
- > Back panel with square holes 10 x 38 mm
- > Separate central locking of drawers and shutter with cylinder locks
- > Load capacity per drawer 40 kg
- > Total load capacity (workbench) 2000 kg



Code	No.	RAL	Width mm	Height mm	Depth mm	Drawers	Max. load-bearing capacity kg	Number of drawers	Shelves	Crosswise divider	Lengthwise divider	Worktop thickness mm	Weight kg
6618210	BR 1500 LH	GEDORE blue, RAL 5017	2.000	1.790	875	3x Type 1, H = 79 mm 1x Type 2, H = 160 mm 1x Type 3, H = 180 mm	2000	5	1	2	3	40	203,73

GEDORE

STRONG AND POWERFUL TOOLS

AGRI SELECTION

FIND OUT



Whether for standard or special applications, with the powerful and strong tools from **GEDORE**, repairs and maintenance of agricultural machinery can be conducted efficiently, quickly, and safely - and not just during the harvest season.

gedore.com

1504 XL-S-198

WORKBENCH WITH BASIC TOOLSET

198 pieces



- > Ideally suited for service and maintenance work on agricultural machinery
- > GEDORE Check-Tool-System: 2-colour foam insert to check that the set is complete
- > In workbench no. 1504XL 1411
- > 30 mm thick multiplex beech wood worktop, surface additionally protected by linseed oil varnish
- > Large usable storage space with shelf and door
- > 1 XL drawer (W 1055 x D 400 mm), 6 wide drawers (W 640 x D 400 mm) with full extension, removable

€3436,¹³
+ VAT



Code	No.	RAL	Height mm	Width mm	Depth mm	Drawers	Max. load-bearing capacity kg	Number of drawers	Pieces	Weight kg
3434826	1504 XL-S-198	GEDORE blue, RAL 5017	985	1.250	630		1000	7	198	157,5

Contents

Mobile workbench 1504 XL 1411 1.25 m wide, Screwdriver bit set 1/4" 620-024
 Square handle 1/4" 2098, Socket 20 4.4.5 5 5.5 6 7 8 9 10 11 12 13 14 mm
 Screwdriver bit 1/4" IN 20 4 5 6 8 mm, Screwdriver bit ITX 20 T8 T9 T10 T15 T20 T25
 Reversible ratchet 1/4" 2093 U-10, T-handle 1/4" 2087, Extension 2090-2
 Extension 2090-4, Extension 2090-6, Universal joint 2095
 Socket 1/2" 19 10 11 12 13 14 15 16 17 18 19 20 21 22 23 24 25 26 27 28 29 30 32 33 34 36 mm
 Screwdriver socket 1/2" IN 19 4 5 6 7 8 9 10 12 14 17 19
 Screwdriver socket 1/2" ITX 19 L T20-100 T25-100 T27-100 T30-100 T40-100 T45-100 T50-100 T55-100 T60-100
 Reversible ratchet 1/2" 1993 U-10 T, T-handle 1/2" 1987, Extension 1/2" 1990-3, Extension 1/2" 1990-5, Extension 1/2" 1990-10
 Universal joint 1/2" 1995, Combination spanner 1 B 6 7 8 9 10 11 12 13 14 15 16 17 18 19 20 21 22 23 24 25 26 27 30 32 34 mm
 Offset screwdriver set H 42 EL-88, Allen keys 42 EL 12 14, 3C-Screwdriver, short pattern 2153 5.5, 3C-Screwdriver with striking cap 2154SK 3.5 5.5 6.5 8
 3C-Screwdriver short pattern 2161 PH 2, 3C-Screwdriver with striking cap 2160SK PH 1 PH 2 PH 3 PH 4
 3C-Screwdriver 2163 TX T10 T15 T20 T25 T30 T40, Flat workshop file 10" 8701 2-10 | 250x25mm
 Round workshop file 10" 8722 2-10 | 250x10 mm, Half-round workshop file 10" 8725 2-10 | 250x25 mm
 Water pump pliers 10" 142 10 tsp, Gedore grip pliers 137 10, Combination pliers 8210-160 JC, Kraft side cutter 8316-200 JC
 Multiple pliers 8133-180 JC, Needle nose pliers 8132 AB-200 JC
 Assembly pliers set S 8008, 8 pcs, Pliers wrench 10" 183 10 JC
 Locksmith's hammer ROTBAND-PLUS 600 H-600 S
 Locksmith's hammer ROTBAND-PLUS 600 H-1500
 Soft face hammer 248 H-50, Pin Punch 119-2 2 3 4 5 6 7 8 9 10mm
 Grains 100-12, Slotted chisel 104
 Cross chisel flat oval 96-175 | 175x17x11mm
 Feeler gauge 702 13 M, Gasket scraper 133 K
 Steel tape measure 4534-8 | 8m
 Pocket vernier caliper 710
 Car light test lamp 4610
 Wire brush 644, Mounting lever 39
 Solid foam kneebord 906
 Magnetic lifter 640-1800

1504 XL-S-306
**WORKBENCH WITH
 PROFESSIONAL RANGE**
 306 pieces

- › Ideally suited for service and maintenance work on agricultural machinery
- › GEDORE Check-Tool-System: 2-colour foam insert to check that the set is complete
- › In workbench no. 1504XL 1411
- › 30 mm thick multiplex beech wood worktop, surface additionally protected by linseed oil varnish
- › Large usable storage space with shelf and door
- › 1 XL drawer (W 1055 x D 400), 6 wide drawers (W 640 x D 400 mm) fully extendable, removable



Code	No.	RAL	Height mm	Width mm	Depth mm	Drawers	Max. load-bearing capacity kg	Number of drawers	Pieces	Weight kg
3434834	1504 XL-S-306	GEDORE blue, RAL 5017	985	1.250	630		1000	9	306	182,9

Contents

Rolling workbench extra wide 1504 XL 1710 | 1.25 m, Screwdriver bit set 1/4" 620-024, Square handle 1/4" 2098
 Socket 20 4 4.5 5 5.5 6 7 8 9 10 11 12 13 14 mm, Screwdriver bit 1/4" IN 20 4 5 6 8 mm, Screwdriver bit ITX 20 T8 T9 T10 T15 T20 T25
 Reversible ratchet 1/4" 2093 U-10, T-handle 1/4" 2087, Extension 2090-2-4-6, Universal joint 2095
 Socket 1/2" 19 10 11 12 13 14 15 16 17 18 19 20 21 22 23 24 25 26 27 28 29 30 32 33 34 36 mm
 Socket 1/2" D 19 L 10 L 12 L 13 L 14 L 15 L 16 L 17 L 18 L 19 L 21 L 22 L 24 L 27 L 30 L 32 mm
 Screwdriver bit 1/2" IN 19 4 5 6 7 8 9 10 12 14 17 19 mm
 Screwdriver bit 1/2" IN 19 L 6-140 7-140 8-140 9-140 10-140 12-140 14-140 mm
 Screwdriver bit 1/2" ITX 19 L T20-100 T25-100 T27-100 T30-100 T40-100 T45-100 T50-100 T55-100 T60-100
 Socket 1/2" TX 19 E10 E11 E12 E14 E16 E18 E20 E24, Reversible ratchet 1/2" 1993 U-10 T
 T-handle 1/2" 1987, Extension 1/2" 1990-3 -5-10, Universal joint 1/2" 1995
 Impact socket 1/2" K 19 17 18 19 21 22 23 24 27 30 32, Impact extension 1/2" KB 1990-5
 Adapter set S 2032-05, 5 pieces, Check tool inlay with assortment 2005 CT4-7 XL
 Combination spanner 1 B 6 7 8 9 10 11 12 13 14 15 16 17 18 19 20 21 22 23 24 25 26 27 30 32 34 mm
 Open-end wrench with ring ratchet 7 R 10 11 12 13 14 15 16 17 18 19 21 22 24 mm
 Starter block wrench 304 13x15 14x17 19x22 mm, Double ended flare nut spanner 400 9x11 10x12 13x15 14x17 19x22 24x27
 Allen Key set H 42 EL-88, Allen keys, long 42 EL 12 14, Allen key set PH 42-88, 8 pieces
 Allen keys 42 7 9 12 14 17 19 22 mm, 3C-Screwdriver, short pattern 2153 5.5
 3C-Screwdriver with striking cap 2154SK 3.5 5.5 6.5 8, 3C-Screwdriver short pattern 2161 PH 2
 3C-Screwdriver with striking cap 2160SK PH 1 PH 2 PH 3 PH 4, 3C-Screwdriver 2163 TX T10 T15 T20 T25 T30 T40
 Nut drivers 2133 6 7 8 10 11 12 13 mm, Flat blunt workshop file 8701 2-10 | 10"
 Round workshop file 8722 2-10 | 10", Half-round workshop file 8725 2-10 | 10"
 Water pump pliers 142 10 TL | 10", GEDORE Grip pliers 137 10, Combination pliers 8210-160 JC
 Power side cutter 8316-200 JC, Multiple pliers 8133-180 JC, Needle nose pliers 8132 AB-200 JC
 Assembly pliers set S 8008, 8 pieces, Pliers wrench 183 10 JC | 10"
 Locksmith's hammer ROTBAND-PLUS 600 H-600, Locksmith's hammer ROTBAND-PLUS 600 H-1500
 Soft face hammer 248 H-50, Pin punch 119-2 2 3 4 5 6 7 8 9 10, Grains 100-12
 Slotted chisel 104, Cross chisel flat oval 96-175 | 175x17x11mm, Feeler gauge 702 13 M
 Gasket scraper 133 K, Steel tape measure 4534-8 | 8m
 Pocket vernier caliper 710, Car light test lamp 4610
 Wire brush 644, Mounting lever 39, Solid 906 foam kneeboard, Magnetic lifter 640-1800

WIDE SELECTION OF TOOLS

S 1500 ES-01 MODULE ASSORTMENT SMALL 104 pieces

€881,⁵¹
+ VAT



- › General basic assortment for beginners of all professions
- › Metric tool sizes
- › Proven GEDORE ES tool modules in ABS plastic

6,3 1/4" 12,5 1/2"

Code	No.	Contents	Pieces	Weight kg
2319845	S 1500 ES-01	Combination spanner No. 1 B 6 7 8 9 10 11 12 13 14 15 16 17 18 19 20 21 22 Allen keys No. 42 2 2.5 3 4 5 6 8 10 Socket 1/2" hexagon UD-profile No. 19 10 11 12 13 14 15 16 17 18 19 21 22 23 24 26 27 28 30 32 1/2" Screwdriver socket for in-hex No. IN 19 6 7 8 9 10 12 14 1/2" Reversible ratchet No. 1993 U-20 1/2" T-handle No. 1987 1/2" Universal joint No. 1995 1/2" Extension No. 1990-5 -10 1/4" Socket No. 20 4 5 5.5 6 7 8 9 10 11 12 13 14 1/4" Screwdriver socket for in-hex No. IN 20 3 4 5 6 8 1/4" Socket wrench for external TX No. TX 20 E4 E5 E6 E7 E8 E10 1/4" Screwdriver socket for internal TX No. ITX 20 T8 T9 T10 T15 T20 T25 T27 T30 T40 1/4" T-handle No. 2087 1/4" Extension No. 2090-4 1/4" Universal joint No. 2095 1/4" Driving handle No. 2098 1/4" Reversible ratchet No. 2093 U-10 3C-Screwdriver slotted No. 2150 4 5.5 6.5 8 3C-Screwdriver PH No. 2160 PH 1 2 Universal pliers No. 142 10 JC Power combination pliers No. 8250-180 JC Flat nose pliers No. 8132-160 JC Power side cutters No. 8316-160 JC Engineer's hammer No. 600 H-300 Flat chisel, octagonal No. 97-250 Cross-cut chisel, octagonal No. 98-125 Drift punch, octagonal No. 99 12-5 Centre punch, octagonal No. 100-12 Pin punch, octagonal No. 119-1,5 3 4	104	14,02

S 1500 ES-02
MODULE ASSORTMENT
MIDDLE
 207 pieces

- › Basic equipment for the commercial sector or ambitious DIY enthusiast
- › Metric tool sizes
- › Proven GEDORE ES tool modules in ABS plastic



Code	No.	Contents	Pieces	Weight kg
2319853	S 1500 ES-02	Combination spanner No. 1 B 6 7 8 9 10 11 12 13 14 15 16 17 18 19 20 21 22 Allen keys No. 42 2 2,5 3 4 5 6 8 10 Double open-end spanner No. 6 6x7 8x9 10x11 12x13 14x15 16x17 18x19 20x22 21x23 24x27 1/2" Socket No. 19 10 11 12 13 14 15 16 17 18 19 21 22 23 24 26 27 28 30 32 1/2" Impact socket No. K 19 10 13 14 17 19 1/2" Screwdriver socket slotted No. IS 19 10x1.6 12x2 1/2" Screwdriver socket PH No. IKS 19 2 3 4 1/2" Screwdriver socket XZN No. INX 19 8 10 1/2" Screwdriver socket TX No. ITX 19 T20 T25 T27 T30 T40 T45 T50 T55 T60 1/2" Screwdriver socket TX, long No. ITX 19 L T20-100 T25-100 T27-100 T30-100 T40-100 T45-100 T50-100 T55-100 T60-100 1/2" Screwdriver socket No. IN 19 5 6 7 8 9 10 12 14 17 1/2" Screwdriver socket, long No. IN 19 L 5-90 6-90 8-90 10-140 12-140 14-140 1/2" Reversible ratchet 1993 U-20 1/2" T-handle No. 1987 1/2" Universal joint No. 1995 1/2" Extension No. 1990-5 -10 1/4" Socket No. 20 4 5 5.5 6 7 8 9 10 11 12 13 14 1/4" Screwdriver socket for in-hex No. IN 20 3 4 5 6 8 1/4" Socket wrench for external TX No. TX 20 E4 E5 E6 E7 E8 E10 1/4" Screwdriver socket for internal TX No. ITX 20 T8 T9 T10 T15 T20 T25 T27 T30 T40 1/4" T-handle No. 2087 1/4" Extension No. 2090-4 1/4" Universal joint No. 2095 1/4" Driving handle No. 2098 1/4" Reversible ratchet No. 2093 U-10 5/16" Screwdriver bit slotted No. 880 7 8 9 12 5/16" Screwdriver bit in-hex No. 885 5 6 8 10 5/16" Screwdriver bit No. 890 1 2 3 4 TX Gauge No. 708 Socket wrench with 2C-T-Handle No. 2133 5,5 6 7 8 9 10 Open-end spanner with ring ratchet No. 7 R 8 10 12 13 14 15 16 17 18 19 3C-Screwdriver for slotted No. 2150 4 5.5 6.5 8 3C-Screwdriver for No. 2160 PH 1 2 Adaptor 5/16" hexagon - 1/2" square No. KB 819 Circlip pliers for external retaining rings No. 8000 A 1 A 2 A 21 Circlip pliers for internal retaining rings No. 8000 J 1 J 2 J 21 Universal pliers No. 142 10 JC Power combination pliers No. 8250-180 JC Flat nose pliers No. 8132-160 JC Power side cutters No. 8316-160 JC Flat chisel, octagonal No. 97-250 Cross-cut chisel, octagonal No. 98-125 Drift punch, octagonal No. 99 12-5 Centre punch, octagonal No. 100-12 Pin punch, octagonal No. 119-1.5 3 4 Engineer's hammer No. 600 H-300 Thread file No. 140 Steel tape measure No. 4534-5 TX Gauge No. 708 Digital measuring calliper No. 711 Tweezers No. 720 Scriber No. 745 1/2" Screw remover No. K 1900 Distance module empty No. 1500 ED-70 K, 475x77x40 mm [6x]	207	28,3

S 1500 ES-03
MODULE ASSORTMENT
LARGE
 325 pieces

- › Extensive industrial range for professionals
- › Metric tool sizes
- › Proven GEDORE ES tool modules in ABS plastic

€2483,¹⁹ + VAT



Code	No.	Contents	Pieces	Weight kg
2319861	S 1500 ES-03	Traverse 2-arm No. 106/103, Traverse 3-arm No. 107/103 Pressure spindle for puller No. 1.1406140, puller hook No. 106/S100-E Combination spanner with equal spanner sizes No. 1 B 6 7 8 9 10 11 12 13 14 15 16 17 18 19 20 21 22 Double-jointed spanner No. 34 8x9 10x11 12x13 14x15 16x17 Double ring spanner No. 2 6x7 8x9 10x11 12x13 14x15 16x17 18x19 20x22 Double open-end spanner No. 6 6x7 8x9 10x11 12x13 14x15 16x17 18x19 20x22 21x23 24x27 Double ring spanner No. 400 8x10 10x11 12x14 13x15 17x19, open Open-end spanner with ring ratchet No. 7 R 8 10 12 13 14 15 16 17 18 19 Open-end spanner, adjustable No. 60 P 8 10" 1/2" socket No. 19 10 11 12 13 14 15 16 17 18 19 21 22 23 24 26 27 28 30 32 1/2" hexagon socket No. K 19 10 13 14 17 19 1/2" Screwdriver bit, slotted No. IS 19 10x1.6 12x2 1/2" Screwdriver bit PH No. IKS 19 2 3 4 1/2" Screwdriver bit insert for internal multi-tooth screws XZN No. INX 19 8 10 1/2" screwdriver bit for hexagon socket screws No. IN 19 5 6 7 8 9 10 12 14 17 1/2" screwdriver bit for hexagon socket screws No. IN 19 L 5-90 6-90 8-90 10-140 12-140 14-140, long 1/2" screwdriver bit XZN No. ITX 19 T20 T25 T27 T30 T40 T45 T50 T55 T60 1/2" screwdriver bit XZN No. ITX 19 L T20-100 T25-100 T27-100 T30-100 T40-100 T45-100 T50-100 T55-100 T60-100, long 1/2" reversible ratchet 1993 U-20, 1/2" cross handle No. 1987, 1/2" universal joint No. 1995, 1/2" extension No. 1990-5 -10 1/4" socket No. 20 4 5 5.5 6 7 8 9 10 11 12 13 14 1/4" screwdriver bit for hexagon socket screws No. IN 20 3 4 5 6 8 1/4" socket for external TX screws No. TX 20 E4 E5 E6 E7 E8 E10 1/4" screwdriver bit for internal TX screws No. ITX 20 T8 T9 T10 T15 T20 T25 T27 T30 T40 1/4" cross handle No. 2087, 1/4" extension No. 2090-4, 1/4" universal joint No. 2095 1/4" square socket No. 2098, 1/4" reversible ratchet No. 2093 U-10 1/4" socket No. 20 L, SW 4 4.5 5 6 7 8 9 10 12 13 mm 1/4" screwdriver bit No. 680, SW 4 5.5 6.5 8 mm 1/4" screwdriver bit no. 685, SW 2.5 3 4 5 6 mm, 1/4" screwdriver bit no. 685 X 5 6 8 mm 1/4" screwdriver bit No. 687 TX T6 T7 T8 T9 T10 T15 T20 T25 T27 T30 T40 1/4" screwdriver bit No. 690 1 2 3, 1/4" screwdriver bit No. 690 PZD 1 2 3, 1/4" bit adapter No. 620 5/16" screwdriver bit for slotted screws No. 880 7 8 9 12 5/16" screwdriver bit for hexagon socket screws No. 885 5 6 8 10 5/16" screwdriver bit for Phillips screws No. 890 1 2 3 4 Connector 5/16" hexagon - 1/2" square No. KB 819, insert holder No. 673 6.3, bit holder No. 699 Multi-handle No. 676, combination holding tool No. 639, socket spanner with 2CT-handle No. 2133 5.5 6 7 8 9 10 3C screwdriver for slotted screws No. 2150 4 5 5.5 6 5 8 3C screwdriver for Phillips screws No. 2160 PH 1 2 3C screwdriver for internal TX screws No. 2163 TX T8 T10 T15 T20 T25 T30 Hexagon socket screwdriver for hexagon socket screws No. 42 2.2 5 3 4 5 6 8 10 Hexagon socket screwdriver for hexagon socket screws No. 42 KEL 2 2.5 3 4 5 6 8 10 mm, extra long, with ball head Hex key L-wrenches for internal TX screws No. 43 KTX T10 T15 T20 T25 T27 T30 T40, with ball head Hex key L-wrenches with 2CT-handle for hexagon socket screws No. DT 2142 2.2 5 3 4 5 6 7 8 10 Assembly pliers for external circlips No. 8000 A 1 A 2 A 21 Assembly pliers for internal circlips No. 8000 J 1 J 2 J 21 Grip pliers No. 137 10, universal pliers No. 142 10 C, power combination pliers No. VDE 8250-180 H Round nose pliers with cutting edge No. VDE 8132-160 H VDE diagonal cutters with sheath insulation No. VDE 8314-160 H Flat chisel, 8-sided No. 97-250, Cross chisel, 8-sided No. 98-125, Punch, 8-sided No. 99 12-5 Centre punch, 8-sided No. 100-12, pin punch, 8-sided No. 119-1.5 3 4, locksmith's hammer No. 600 H-300 Steel tape measure No. 4534-5, TX screw gauge No. 708, digital caliper No. 711, tweezers No. 720, scriber No. 745 1/2" screwdriver No. K 1900, screw extractor No. 8551 M3-M6 M6-M8 M8-M11 M11-M14 M14-M18 Voltage tester No. 4615 3, 220-250 V, 3mm, cable cutter No. 0513-09, 195 mm, gasket scraper No. 133 K TX screw gauge No. 708, thread file No. 140, flat, triangular, square, half-round, round file No. 8728 Miniature LED light No. 649, empty spacer module No. 1500 ED-70 K, 475x77x40 mm [7x]	325	38

TS-147

TOOL ASSORTMENT

in check tool modules, 147 pieces

- › Metric tool sizes
- › GEDORE Check-Tool-System: 2-colour foam insert to check that the set is complete
- › Each tool is securely held in its own pocket, grip recesses facilitate easy removal of the tools
- › Resistant to oil and grease



€839,⁵⁰
+ VAT

1/4" 1/2"

Code	No.	Contents	Pieces	Weight kg
2955997	TS-147	1/4" Reversible ratchet No. 2093 U-20 1/4" Wobble extension No. 2090 KR-4 1/4" T-handle No. 2087 1/4" Socket UD-profile No. D 20 4 5 5,5 6 7 8 9 10 11 12 13 1/4" Socket No. TX 20 E4 E5 E6 E7 E8 E10 1/4" Screwdriver bit slotted No. 680 4 5 5 6 5 8 1/4" Screwdriver bit in-hex No. 685 2.5 3 4 5 6 1/4" Screwdriver bit XZN No. 685 X 5 6 8 1/4" Screwdriver bit PH No. 690 1 2 3 1/4" Screwdriver bit PZ No. 690 PZD 1 2 3 1/4" Screwdriver bit TX No. 687 TX T6 T7 T8 T9 T10 T15 T20 T25 T27 T30 T40 1/4" Multi handle No. 676 1/4" Bit holder No. 699 1/2" Reversible ratchet No. 1993 U-20 1/2" Extension No. 1990-2.1/2 1/2" Wobble extension No. 1990 KR-5 -10 1/2" Socket No. D 19 10 11 12 13 14 15 16 17 18 19 21 22 24 27 30 32 1/2" Screwdriver socket in-hex No. IN 19 5 6 7 8 9 10 12 14 Insert holder 1/4" hexagon - 1/4" square No. 673 6.3 Bit-Adapter 1/4" hexagon - 1/4" square No. 620 Combination spanner UD-profile No. 7 8 9 10 11 12 13 14 15 16 17 18 19 20 21 22 24 Allen Key set No. PH 42-88 (2-10 mm) 3C-Screwdriver slotted No. 2154SK 3.5 5.5 6.5 8 3C-Screwdriver PH No. 2160SK PH 1 2 Universal pliers No. 142 10 TL Power combination pliers No. 8250-180 JC Multiple pliers No. 8133-200 JC Power side cutters No. 8316-180 JC Engineer's hammer No. 4 E-500 Centre punch No. 100-12 Pin punch No. 119-1.5 -3 -4 Flat chisel No. 97-250 Cross-cut chisel No. 98-125 Drift punch No. 99 12-5 Twist drill set No. 8550-024	147	11,98

TS-190
TOOL ASSORTMENT
 in Check-Tool-Modules, 190 pieces

- › Metric tool sizes
- › GEDORE Check-Tool-System: 2-colour foam insert to check that the set is complete
- › Each tool is securely held in its own pocket, grip recesses facilitate easy removal of the tools
- › Resistant to oil and grease



€1175,⁶³
 + VAT

1/4" 1/2"

Code	No.	Contents	Pieces	Weight kg
2956527	TS-190	1/4" Reversible ratchet No. 2093 U-20, 1/4" Wobble extension No. 2090 KR-4 1/4" T-handle No. 2087 1/4" Socket UD-profile No. D 20 4 5 5.5 6 7 8 9 10 11 12 13 1/4" Socket No. TX 20 E4 E5 E6 E7 E8 E10 1/4" Screwdriver bit slotted No. 680 4 5.5 6 5 8 1/4" Screwdriver bit in-hex No. 685 2.5 3 4 5 6 1/4" Screwdriver bit XZN No. 685 X 5 6 8 1/4" Screwdriver bit PH No. 690 1 2 3 1/4" Screwdriver bit PZ No. 690 PZD 1 2 3 1/4" Screwdriver bit TX No. 687 TX T6 T7 T8 T9 T10 T15 T20 T25 T27 T30 T40 1/4" Multi handle No. 676, 1/4" Bit holder No. 699 1/2" Reversible ratchet No. 1993 U-20, 1/2" Extension No. 1990-2.1/2 1/2" Wobble extension No. 1990 KR-5 -10 1/2" Socket No. D 19 10 11 12 13 14 15 16 17 18 19 21 22 24 27 30 32 1/2" Screwdriver socket in-hex No. IN 19 5 6 7 8 9 10 12 14 1/2" Screwdriver socket XZN No. INX 19 6 8 10 12 1/2" Screwdriver socket in-hex No. IN 19 L 5-90 6-90 8-90 10-140 12-140 14-140, long 1/2" Screwdriver socket TX No. ITX 19 T20 T25 T27 T30 T40 T45 T50 T55 T60 1/2" Screwdriver socket TX No. ITX 19 L T20-100 T25-100 T27-100 T30-100 T40-100 T45-100 T50-100 T55-100 T60-100, long Insert holder 1/4" hexagon - 1/4" square No. 673 6.3 Bit-Adapter 1/4" hexagon - 1/4" square No. 620 Combination spanner UD-profile No. 7 8 9 10 11 12 13 14 15 16 17 18 19 20 21 22 24 Double open-end spanner No. 6 6x7 8x9 10x11 12x13 14x15 16x17 18x19 20x22 24x27 Allen key set No. PH 42-88 (2-10 mm), 3C Screwdriver slotted No. 2154SK 3.5 5.5 6.5 8 3C Screwdriver PH No. 2160SK PH 1 2 Universal pliers No. 142 10 TL Power combination pliers No. 8250-180 JC Multiple pliers No. 8133-200 JC Power side cutters No. 8316-180 JC Circlip pliers for external retaining rings No. 8000 A 1 A 2 A 21 Circlip pliers for internal retaining rings No. 8000 J 1 J 2 J 21 Engineer's hammer No. 4 E-500 Centre punch No. 100-12, Pin punch No. 119-1.5 -3 -4 Flat chisel No. 97-250, Cross-cut chisel No. 98-125 Drift punch No. 99 12-5, Twist drill set No. 8550-024	190	17,08

TS-308

TOOL ASSORTMENT

in Check-Tool-Modules, 308 pieces



- › Metric tool sizes
- › GEDORE Check-Tool-System: 2-colour foam insert to check that the set is complete
- › Each tool is securely held in its own pocket, grip recesses facilitate easy removal of the tools
- › Resistant to oil and grease



€2335,²⁹ + VAT

1/4" 1/2" 3/8"

Code	No.	Contents	Pieces	Weight kg
2956535	TS-308	1/4" Reversible ratchet No. 2093 U-20, 1/4" Wobble extension No. 2090 KR-4, 1/4" T-handle No. 2087 1/4" Socket UD-profile No. D 20 4 5 5.5 6 7 8 9 10 11 12 13, 1/4" Socket insert No. TX 20 E4 E5 E6 E7 E8 E10 1/4" Screwdriver bit slotted No. 680 4 5.5 6.5 8, 1/4" Screwdriver bit in-hex No. 685 2.5 3 4 5 6, 1/4" Screwdriver bit XZN No. 685 X 5 6 8 1/4" Screwdriver bit PH No. 690 1 2 3, 1/4" Screwdriver bit PZ No. 690 PZD 1 2 3 1/4" Screwdriver bit TX No. 687 TX T6 T7 T8 T9 T10 T15 T20 T25 T27 T30 T40, 1/4" Multi handle No. 676, 1/4" Bit holder No. 699 1/2" Reversible ratchet No. 1993 U-20, 1/2" Extension No. 1990-2.1/2, 1/2" Wobble extension No. 1990 KR-5 -10 1/2" Socket No. D 19 10 11 12 13 14 15 16 17 18 19 21 22 24 27 30 32, 1/2" Screwdriver socket in-hex No. IN 19 5 6 7 8 9 10 12 14 1/2" Screwdriver socket XZN No. INX 19 6 8 10 12, 1/2" Screwdriver socket in-hex No. IN 19 L 5-90 6-90 8-90 10-140 12-140 14-140, long 1/2" Screwdriver socket TX No. ITX 19 T20 T25 T27 T30 T40 T45 T50 T55 T60 1/2" Screwdriver socket TX No. ITX 19 L T20-100 T25-100 T27-100 T30-100 T40-100 T45-100 T50-100 T55-100 T60-100, long 1/2" Impact socket bit with protective sleeve No. K 19 LS 17 19 21, 5/16" Screwdriver bit slotted No. 880 7 8 9 12 ST-40 5/16" Screwdriver bit in-hex No. 885 5 6 8 10, 5/16" Screwdriver bit PH No. 890 1 2 3 4 3/8" Reversible ratchet No. 3093 U-20 Recoilless hammer No. 248, 3/8" Wobble extension No. 3090 KR-5 -10 3/8" Socket wrench UD-profile No. D 30 6 7 8 9 10 11 12 13 14 15 16 17 18 19 20 21 22 24, 3/8" Screwdriver socket in-hex No. IN 30 5 6 7 8 10 3/8" Screwdriver socket XZN No. INX 30 5 6 8 10, 3/8" Screwdriver socket TX No. ITX 30 T20 T25 T27 T30 T40 T45 T50 Insert holder 1/4" hexagon - 1/4" square No. 673 6,3, Bit-Adapter 1/4" hexagon - 1/4" square No. 620 Adaptor 5/16" hexagon - 1/2" square No. KB 819, Open-end spanner with ring ratchet UD-profile No. 7 R 8 10 12 13 14 15 16 17 18 19 Combination spanner UD-profile No. 7 8 9 10 11 12 13 14 15 16 17 18 19 20 21 22 24 Double open-end spanner No. 6 6x7 8x9 10x11 12x13 14x15 16x17 18x19 20x22 24x27 Double ring-end spanner UD-profile No. 2 6x7 8x9 10x11 12x13 14x15 16x17 18x19 20x22 Double end flare nut spanner No. 400 8x10 10x11 12x14 13x15 17x19, open, Allen key set No. PH 42-88 (2-10 mm) Offset screwdriver set No. H 43 TX-09, 3C-Screwdriver slotted No. 2154SK 3.5 5.5 6.5 8, 3C-Screwdriver PH No. 2160SK PH 1 2 3C-Screwdriver TX No. 2163 TX T10 T15 T20 T25 T30 T40, Nut driver No. 2133 5.5 6 7 8 9 10, Universal pliers No. 142 10 TL Power combination pliers No. 8250-180 JC, Multiple pliers No. 8133-200 JC, Power side cutters No. 8316-180 JC Circlip pliers for external retaining rings No. 8000 A 1 A 2 A 21, Circlip pliers for internal retaining rings No. 8000 J 1 J 2 J 21 Engineer's hammer No. 4 E-500, Centre punch No. 100-12, Pin punch No. 119-1.5 -3 -4 Flat chisel No. 97-250, Cross-cut chisel No. 98-125, Drift punch No. 99 12-5 Twist drill set No. 8550-024, Hacksaw No. 407, Grip pliers 10" No. 137 10 Steel tape measure, 5m No. 4534-5, Screw remover 1/2" No. K 1900, Cable knife No. 0063-08 Wire brush No. 646, Pocket vernier caliper No. 710 Key file set No. 8728, Bolt extractor set No. 8551-55 Gasket scraper No. 133 K, Feeler gauge set, fan pattern No. 702 20 M	308	30,14

1500 CT1-1993 U-20 ACCESSORIES FOR 1/2" SOCKETS

in 1/3 Check Tool Module, 5 pieces

€125,²¹ + VAT



- › Perfect set for hand-operated loosening and tightening of screws and nuts
- › With Check-Tool insert for quick check of tool completeness

12,5 1/2" ■ ■ ■

Code	No.	Contents	Width mm	Depth mm	Pieces	Weight kg
2309114	1500 CT1-1993 U-20	1993 U-20, 1987, 1995, 1990-5 -10	158	310	5	1,7

1500 CT1-20
1/4" SOCKET SET
 in 1/3 Check-Tool-Module,
 37 pieces

€225,²¹
 + VAT



- › Extensive range of accessories for the most common bolting applications
- › With Check-Tool insert for quick check of tool completeness

6,3 1/4

Code	No.	Contents	Width mm	Depth mm	Pieces	Weight kg
2308967	1500 CT1-20	1/4" Socket No. 20 hex 4 5 5.5 6 7 8 9 10 11 12 13 14 mm 1/4" Screwdriver bit socket No. IN 20 hex 3 4 5 6 8 mm 1/4" Screwdriver bit socket No. ITX 20, T8 T9 T10 T15 T20 T25 T27 T30 T40 mm 1/4" Socket No. TX 20, E4 E5 E6 E7 E8 E10 1/4" Sliding T-bar with slider No. 2087, 115 mm 1/4" Extension No. 2090-4. 97 mm, 1/4" Universal joint No. 2095 1/4" Square plug-in handle No. 2098, 2C-Handle, 1/4" Reversible ratchet U-10, 127 mm	158	310	37	0,845

1500 CT1-30
3/8" SOCKET SET
 in 1/3 Check-Tool module,
 24 pieces

€226,⁰⁵
 + VAT



- › Perfect set composition for the most common bolting cases
- › With Check-Tool insert for quick check of tool completeness

10 3/8

Code	No.	Contents	Width mm	Depth mm	Pieces	Weight kg
2308975	1500 CT1-30	3/8" Socket hex No. 30, 6 7 8 9 10 11 12 13 14 15 16 17 18 19 3/8" Screwdriver bit socket hex, No. IN 30, 4 5 6 8 10 mm 3/8" Universal joint No. 3095, 51 mm 3/8" Sliding T-bar No. 3087, 3/8" Extension No. 3090 -5 -10, 125 250 mm 3/8" Reversible ratchet No. 3093 U-10, 200 mm	158	310	24	1,67

1500 CT1-350
CHISEL SET
 in 1/3 Check-Tool module,
 8 pieces

€76,⁸⁰
 + VAT



- › Perfect set composition for the most common stroke applications
- › With Check-Tool insert for quick check of tool completeness



Code	No.	Contents	Width mm	Depth mm	Pieces	Weight kg
2309041	1500 CT1-350	Flat chisel No. 97-250, 250x24 mm, Cross-cut chisel No. 98-125, 125 mm Drift punch No. 99 12-5 12-8, Ø 5 8 mm, Centre punch No. 100-12, 120x12x5 mm Pin punch, No. 119-1.5 3 4 mm Engineers' hammer ROTBAND-PLUS No.600 H-300, with hickory handle 300g	158	310	8	1,425

1500 CT1-142

PLIER SET

in 1/3 Check-Tool module,
4 pieces

€117,⁵⁶
+ VAT

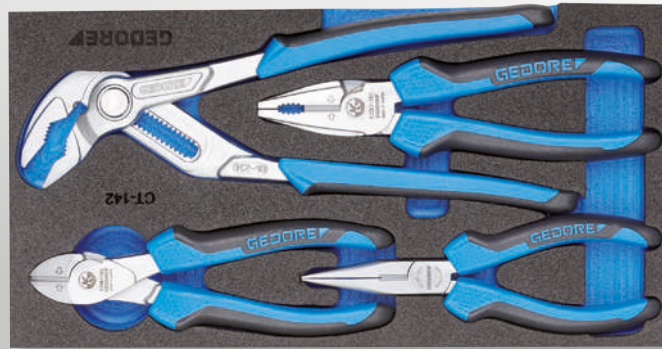

- › Practical set composition for a wide range of applications in all trades
- › With Check-Tool insert for quick check of tool completeness



Code	No.	Contents	Width mm	Depth mm	Pieces	Weight kg
2309025	1500 CT1-142	10" Universal pliers No. 142 10 JC, 2C-Handle Power combination pliers No. 8250-180 JC, 180 mm 2C-Handle Bent nose pliers No. 8132-160 JC, 160 mm 2C-Handle Power side cutter No. 8316-160 JC, 160 mm 2C-Handle	158	310	4	1,217

1500 CT1-8000

SET OF CIRCLIP PLIERS

in 1/3 Check-Tool module, 4 pieces

€98,³²
+ VAT



- › Perfect set composition for inner and outer retaining rings
- › With Check-Tool insert for quick check of tool completeness



Code	No.	Contents	Width mm	Depth mm	Pieces	Weight kg
2309181	1500 CT1-8000	Circlip pliers for external retaining rings No. 8000 A 1 A 2 A 21 Circlip pliers for internal retaining rings No. 8000 J 1 J 2 J 21	158	310	4	1,009

1500 CT1-2133

SOCKET SET

in 1/3 Check-Tool module,
6 pieces

€72,²⁶
+ VAT

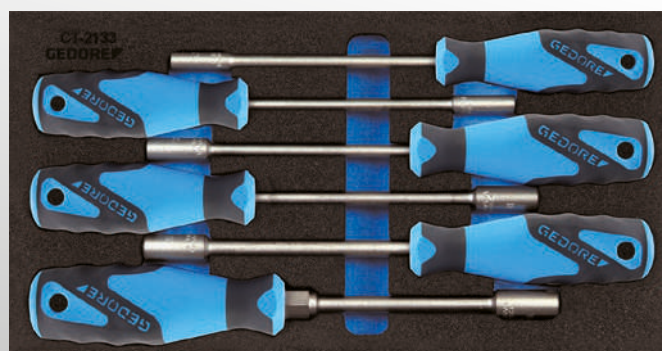

- › Perfect set for easy and quick loosening of screws with hexagonal head and nuts
- › With Check-Tool insert for quick check of tool completeness



Code	No.	Contents	Width mm	Depth mm	Pieces	Weight kg
2309122	1500 CT1-2133	Nut driver with 3C-Handle No. 2133, 5.5 6 7 8 9 10 mm	158	310	6	0,82

1500 CT1-2150 PH
SCREWDRIVER SET
 in 1/3 Check-Tool module, 6 pieces

- › Perfect set for slotted and PH Screws
- › With Check-Tool insert for quick check of tool completeness

€54,¹⁹
 + VAT

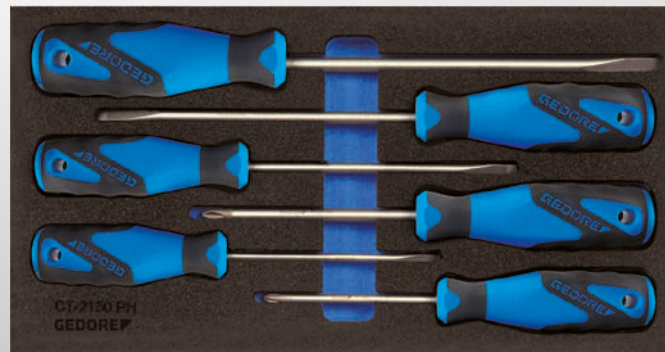

Code	No.	Contents	Width mm	Depth mm	Pieces	Weight kg
2309130	1500 CT1-2150 PH	3C Screwdriver slotted No. 2150, 4.5.5.6.5.8 mm 3C Screwdriver Philips No. 2160 PH 1.2	158	310	6	0,63

1500 CT1-2150 PZ
SCREWDRIVER SET
 in 1/3 Check-Tool module, 6 pieces

- › Perfect set for slotted and PZ Screws
- › With Check-Tool insert for quick check of tool completeness

€54,¹⁹
 + VAT



Code	No.	Contents	Width mm	Depth mm	Pieces	Weight kg
2309149	1500 CT1-2150 PZ	3C Screwdriver slotted No. 2150, 4.5.5.6.5.8 mm 3C Screwdriver Pozi No. 2160 PZ 1.2	158	310	6	0,63

1500 CT1-2163 TX
SCREWDRIVER SET
 in 1/3 Check-Tool module, 6 pieces

- › Perfect set composition for inside TX screws
- › With Check-Tool insert for quick check of tool completeness

€54,¹⁹
 + VAT

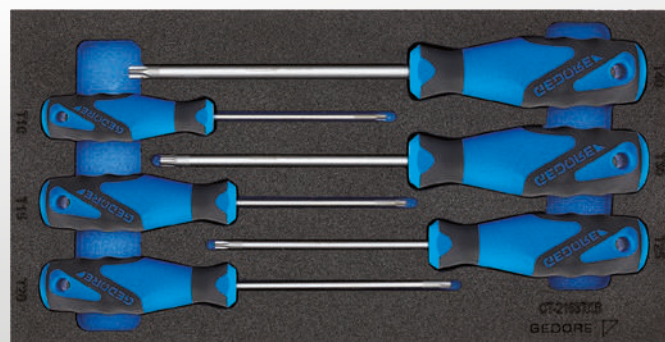

Code	No.	Contents	Width mm	Depth mm	Pieces	Weight kg
2309157	1500 CT1-2163 TX	3C-Screwdriver recessed TX with drill hole No. 2163 TXB, T8 T10 T15 T20 T25 T30 mm	158	310	6	0,4

1500 CT1-2163 TXB SCREWDRIVER SET

in 1/3 Check-Tool module, 6 pieces

- › Perfect set composition for inside TX screws with pin
- › With Check-Tool insert for quick check of tool completeness

€63,²⁷
+ VAT

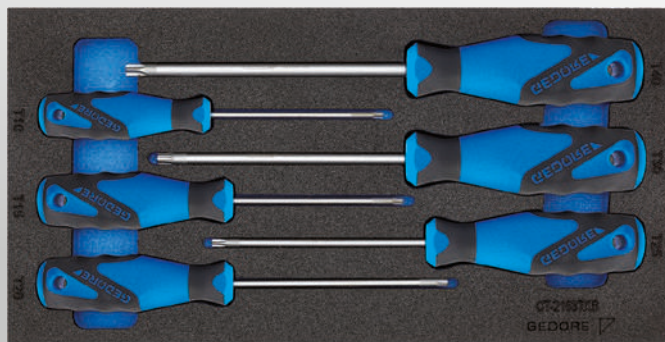

Code	No.	Contents	Width mm	Depth mm	Pieces	Weight kg
2309165	1500 CT1-2163 TXB	3C-Screwdriver recessed TX with drill hole No. 2163 TXB, T10 T15 T20 T25 T30 T40 mm	158	310	6	0,5

1500 CT1-400 DOUBLE ENDED RING SPANNER SET, OPEN

in 1/3 Check Tool Module, 5 pieces

- › Perfect set for the assembly of pipe fittings
- › With Check-Tool insert for quick check of tool completeness

€90,⁶⁷
+ VAT



Code	No.	Contents	Width mm	Depth mm	Pieces	Weight kg
2309068	1500 CT1-400	Double end flare nut spanner hex No. 400, 8x10 10x11 12x14 13x15 17x19 mm	158	310	5	0,565

1500 CT1-2 DOUBLE ENDED RING SPANNER SET

in 1/3 Check-Tool module, 8 pieces

- › Practical set combination for deep-set or recessed nuts
- › With Check-Tool insert for quick check of tool completeness

€98,³²
+ VAT

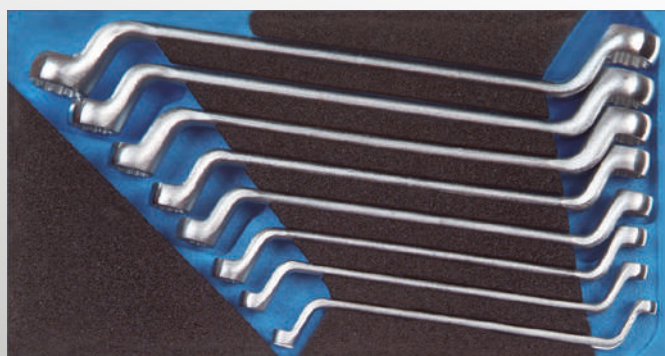

Code	No.	Contents	Width mm	Depth mm	Pieces	Weight kg
2308827	1500 CT1-2	Double ring-end spanner UD-profile No. 2 6x7 8x9 10x11 12x13 14x15 16x17 18x19 20x22 mm	158	310	8	1,36

1500 CT1-6 DOUBLE OPEN ENDED SPANNER SET

in 1/3 Check-Tool-Module, 10 pieces

- › Perfect set for use on nuts and bolts
- › With Check-Tool insert for quick check of tool completeness

€81,34
+ VAT

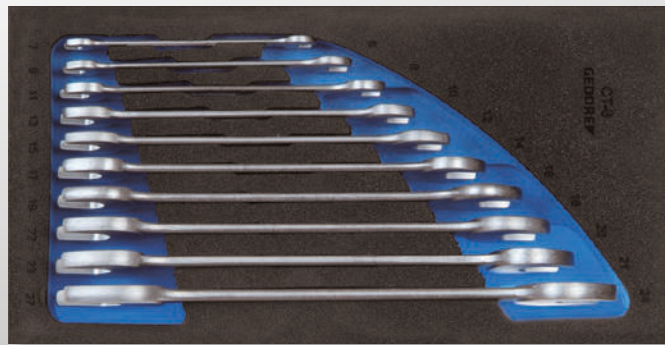

Code	No.	Contents	Width mm	Depth mm	Pieces	Weight kg
2308851	1500 CT1-6	Double open-end spanner No. 6, 6x7 8x9 10x11 12x13 14x15 16x17 18x19 20x22 21x23 24x27 mm	158	310	10	1,44

1500 CT1-7 R COMBINATION RATCHET SPANNER SET

in 1/3 Check-Tool-Module, 10 pieces

- › Perfect set composition for ratcheting release and the quick suit
- › With Check-Tool insert for quick check of tool completeness

€162,18
+ VAT

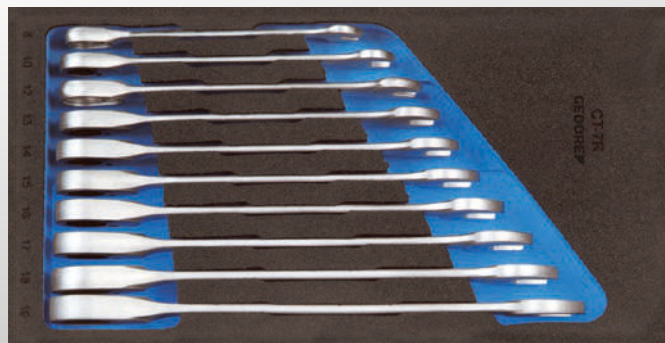

Code	No.	Contents	Width mm	Depth mm	Pieces	Weight kg
2308894	1500 CT1-7 R	Combination ratchet spanner No. 7 R, 8 10 12 13 14 15 16 17 18 19 mm	158	310	10	1,24

1500 CT1-7 UR COMBINATION RATCHET SPANNER SET, REVERSIBLE

in 1/3 Check-Tool-Module, 10 pieces

- › Perfect set composition for ratcheting release and the quick suit
- › Clockwise and counterclockwise rotation possible via switch lever
- › With Check-Tool insert for quick check of tool completeness

€226,05
+ VAT

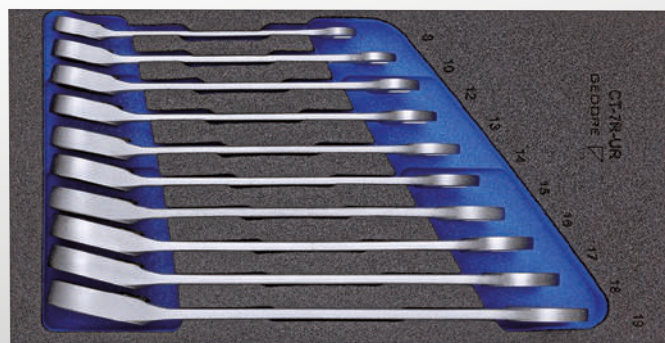

Code	No.	Contents	Width mm	Depth mm	Pieces	Weight kg
2331969	1500 CT1-7 UR	Combination ratchet spanner No. 7 UR, 8 10 12 13 14 15 16 17 18 19 mm	158	310	10	1,245

1500 CT1-D 19 SOCKET SET 1/2", UD-PROFILE

in 1/3 check tool module, 26 pieces

- › Perfect set composition for hand-operated bolting applications
- › With Check-Tool insert for quick check of tool completeness

€198,³²
+ VAT

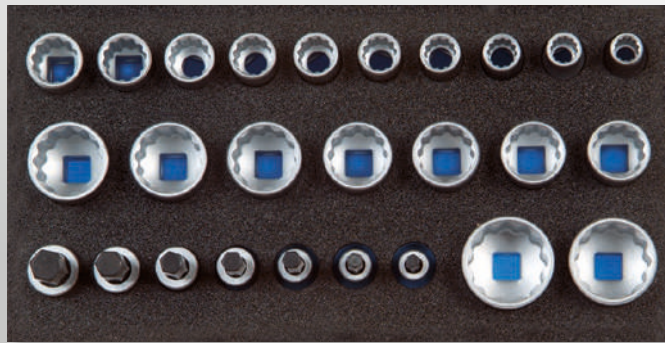

Code	No.	Contents	Width mm	Depth mm	Pieces	Weight kg
2308916	1500 CT1-D 19	Socket 1/2" No. D 19, 10 11 12 13 14 15 16 17 18 19 21 22 23 24 26 27 28 30 32 mm Screwdriver bit socket 1/2" No. IN 19, 6 7 8 9 10 12 14 mm	158	310	26	2,68

1500 CT1-IN 19 LKM 1/2" ALLEN KEY SOCKET SET

in 1/3 Check-Tool module, 13 pieces

- › Perfect set for hexagon socket screws
- › With Check-Tool insert for quick check of tool completeness

€144,⁵⁴
+ VAT



Code	No.	Contents	Width mm	Depth mm	Pieces	Weight kg
2308932	1500 CT1-IN 19 LKM	Screwdriver bit socket 1/2" No. IN 19, 6 7 8 10 12 14 mm Screwdriver bit socket 1/2" No. IN 19 L 6-140 7-140 8-140 9-140 10-140 12-140 14-140	158	310	13	1,9

1500 CT1-INX 19 LK 1/2" ALLEN KEY SOCKET SET

in 1/3 Check-Tool module, 11 pieces

- › Perfect set for inside 12-sided screws
- › With Check-Tool insert for quick check of tool completeness

€170,⁵⁹
+ VAT



Code	No.	Contents	Width mm	Depth mm	Pieces	Weight kg
2957957	1500 CT1-INX 19 LK	INX 19 8 10 12 14 16 18 INX 19 L 6-100 8-100 10-100 12-100 14-100	158	310	11	1,044

1500 CT1-ITX 19 LKP 1/2" ALLEN KEY SOCKET SET

in 1/3 Check-Tool module, 19 pieces

- › Perfect set composition for inside TX screws
- › With Check-Tool insert for quick check of tool completeness

€233,⁶¹
+ VAT



12,5 1/2" ■■■

Code	No.	Contents	Width mm	Depth mm	Pieces	Weight kg
2308940	1500 CT1-ITX 19 LKP	Screwdriver bit socket 1/2" No. ITX 19 T20 T25 T27 T30 T40 T45 T50 T55 T60 Screwdriver bit socket 1/2" No. ITX 19 L T20-100 T25-100 T27-100 T30-100 T40-100 T45-100 T50-100 T55-100 T60-100, TX Screw gauge No. 708	158	310	19	1,915

1500 CT1-ITX 30 3/8" SCREWDRIVER BIT SOCKET SET

in 1/3 Check-Tool-Module, 39 pieces

- › Perfect set composition for TX-recess screws
- › With Check-Tool insert for quick check of tool completeness

€342,⁰²
+ VAT



10 3/8" ■■■

Code	No.	Contents	Width mm	Depth mm	Pieces	Weight kg
2308983	1500 CT1-ITX 30	Socket 3/8" No. TX 30 E5 E6 E7 E8 E10 E11 E12 E14 Screwdriver bit socket 3/8" No. IN 30 L, hexagon 4 5 6 7 8 10 mm Screwdriver bit socket 3/8" No. ITX 30 T20 T25 T27 T30 T40 T45 T50 Screwdriver bit socket 3/8" No. ITX 30 L T20 T25 T27 T30 T40 T45 T50 Screwdriver bit socket 3/8" slotted No. IS 30, 5.5 6.5 8 10 12 mm Screwdriver bit socket 3/8" No. IKS 30 1 2 3, Screwdriver bit socket 3/8" No. IKS 30 PZD 1 2 3	158	310	39	2,175

1500 CT1-K 1900 1/2" IMPACT DRIVER SET

in 1/3 Check-Tool-Module, 23 pieces

- › With powerful screw loosener for removing stuck screws
- › With Check-Tool insert for quick check of tool completeness

€192,⁴⁴
+ VAT

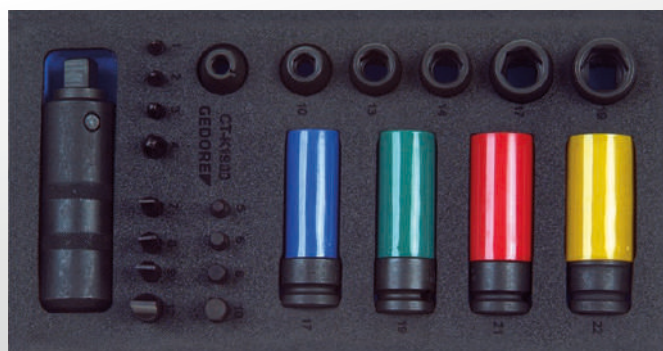

12,5 1/2" 8 5/16" ■■■

Code	No.	Contents	Width mm	Depth mm	Pieces	Weight kg
2309092	1500 CT1-K 1900	K 19 10 13 14 17 19, K 19 LS 17 19 21 22 880 7 8 9 12, 885 5 6 8 10, 890 1 2 3 4, KB 819, K 1900	158	310	23	2,645

1500 CT1-VDE 142
VDE PLIERS SET
 in 1/3 Check-Tool module,
 4 pieces

€112,⁶¹
 + VAT

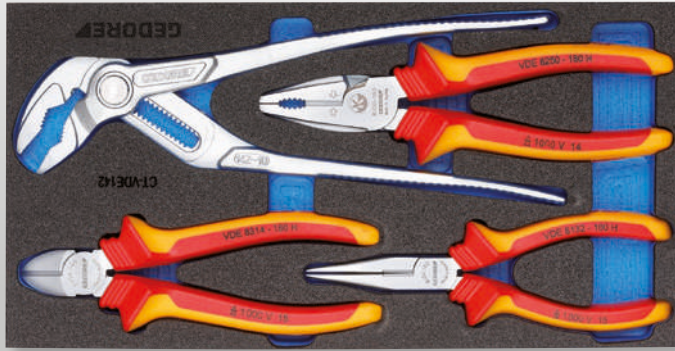

- › Practical set composition for a wide range of applications in the electronics sector
- › With Check-Tool insert for quick check of tool completeness



Code	No.	Contents	Width mm	Depth mm	Pieces	Weight kg
2309033	1500 CT1-VDE 142	Universal pliers No. 142 10 C, 10" VDE Power combination pliers No. VDE 8250-180 H VDE Flat-nosed pliers No. VDE 8132-160 H VDE Side cutter No. VDE 8314-160 H	158	310	4	1,158

1500 CT1-VDE 2170 PZ
VDE SCREWDRIVER SET
 in 1/3 Check-Tool module, 6 pieces

€63,²⁷
 + VAT

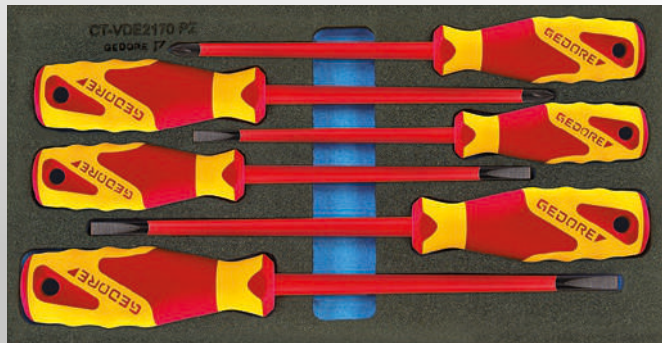

- › Perfect set for slotted and cross-recess PZ screws in the electronics sector
- › With Check-Tool insert for quick check of tool completeness



Code	No.	Contents	Width mm	Depth mm	Pieces	Weight kg
2309173	1500 CT1-VDE 2170 PZ	VDE Screwdriver slotted No. VDE 2170, 4 5.5 6.5 8 mm VDE Screwdriver Pozidriv No. VDE 2160 PZ 1 2	158	310	6	0,625

1500 CT2-7
COMBINATION SPANNER SET
 in 2/3 Check-Tool-Module,
 25 pieces

€180,⁶⁷
 + VAT

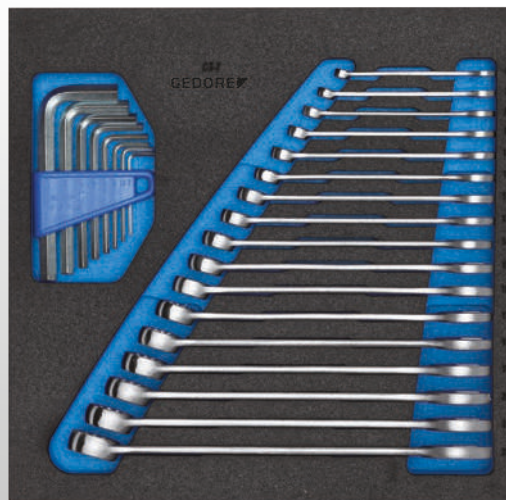

- › Perfect set composition for universal use
- › With Check-Tool insert for quick check of tool completeness



Code	No.	Contents	Width mm	Depth mm	Pieces	Weight kg
2308878	1500 CT2-7	Combination spanner No. 7, 6 7 8 9 10 11 12 13 14 15 16 17 18 19 20 21 22 mm Allen Key set No. PH 42-88 hexagon 2.2 5 3 4 5 6 8 10 mm	315	310	25	1,75

1500 CT2-7-32 COMBINATION SPANNER SET

in 2/3 Check-Tool module,
5 pieces

€112,⁶¹
+ VAT

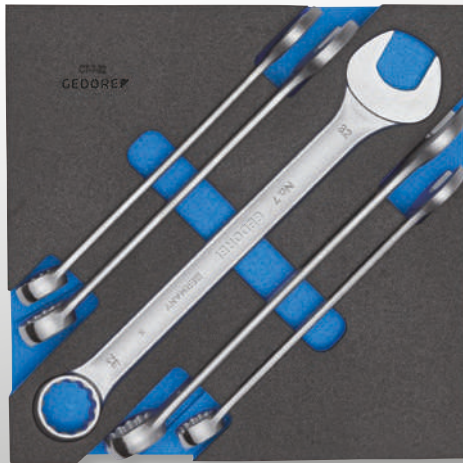

- › Perfect set composition for universal use
- › With Check-Tool insert for quick check of tool completeness



Code	No.	Contents	Width mm	Depth mm	Pieces	Weight kg
230886	1500 CT2-7-32	Combination spanner No. 7, 23 24 27 30 32 mm	315	310	5	1,865

1500 CT2-DT 2142 OFFSET ALLEN KEY SET

9 pieces

€108,⁴⁰
+ VAT

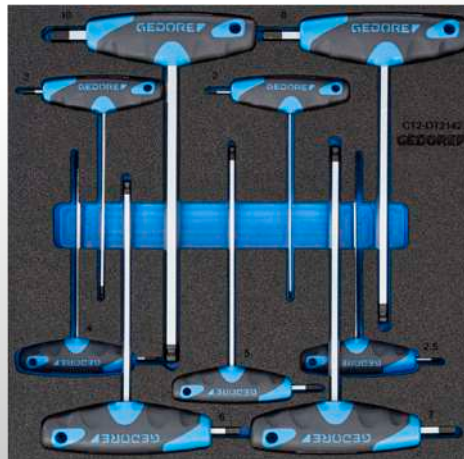

- › Perfect set for hexagon socket screws
- › With Check-Tool insert for quick check of tool completeness



Code	No.	Contents	Width mm	Depth mm	Pieces	Weight kg
2309009	1500 CT2-DT 2142	Allen keys with 2C-T-handle No. DT 2142, 2 2.5 3 4 5 6 7 8 10 mm	315	310	9	0,9

1500 ED-70 K DISTANCE MODULE

empty



€9,⁰⁷
+ VAT

- › For balancing and fixing tool modules No. 1500 ES in drawers of depth 400 mm, for tool trolleys No. 2004 and workbenches No. 1502, 1504, 1505 and 1506 XL



Code	No.	Depth mm	Width mm	Height mm	Weight kg
1618687	1500 ED-70 K	77	475	40	0,12

1500 ED-70 S DISTANCE MODULE 1/3

empty



€18,⁰⁶
+ VAT

- › For tool trolley No. WSL-L7 (workster) and No. 2005, workbench No. 1504 XL and tool chest No. 2430, suitable as spacer for 1/3 module

Code	No.	Depth mm	Width mm	Height mm	Weight kg
1851462	1500 ED-70 S	77	152	40	0,15

1500 ED-70 XL DISTANCE MODULE

empty

€21,67
+ VAT



- › Suitable for torque wrenches and other long hand tools or small pieces
- › For tool trolley No. WSL-L7 (workster) and No. 2005, workbench No. 1504 XL and tool chest No. 2430

Code	No.	Depth mm	Width mm	Height mm	Weight kg
1803069	1500 ED-70 XL	77	625	40	0,854

1500 CTD-20 BIT 1/4" SOCKET ASSORTMENT

in Check-Tool-Module, 45 pieces

€179,83
+ VAT



- › Multi-grip 1/4" with extensive range of bits and sockets
- › Only suitable for tool trolley 2004, and workbenches 1502, 1504, 1505 and 1506 XL
- › For models No. 2005, No. WSL-L7 (workster), No. 2430 and No. 1504 XL order additional distance module No. 1500 ED-70 S



Code	No.	Contents	Width mm	Height mm	Depth mm	Pieces	Weight kg
1733419	1500 CTD-20 BIT	1/4" Socket No. 20 L, 4 4.5 5 6 7 8 9 10 12 13 mm 1/4" Screwdriver bit No. 680, 4 5.5 6.5 8 mm 1/4" Screwdriver bit No. 685, 2.5 3 4.5 6 mm 1/4" Screwdriver bit No. 685 X 5 6 8 mm 1/4" Screwdriver bit No. 687 TX T6 T7 T8 T9 T10 T15 T20 T25 T27 T30 T40 1/4" Screwdriver bit No. 690 1 2 3, 1/4" Screwdriver bit No. 690 PZD 1 2 3 Miniature LED light No.649, Insert holder No. 673 6,3, Bit holder No. 699 1/4" bit adapter No. 620, Multi-handle No. 676, Combination holding tool No. 639	475	40	77	45	0,7

2005 CT2-D 19L 1/2" SOCKET ASSORTMENT

in 2/4 Check-Tool-Module,
40 pieces

€550,42
+ VAT

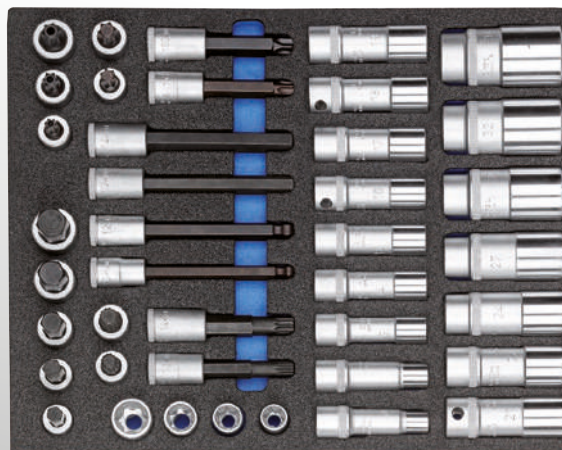

- › Optimum range for deeper screws in the most common wrench sizes
- › With Check-Tool insert for quick check of tool completeness



Code	No.	Contents	Width mm	Depth mm	Pieces	Weight kg
2016516	2005 CT2-D 19L	D 19 L 10 12 13 14 15 16 17 18 19 21 22 24 27 30 32 34, IN 19 10 12 14 17 19 IN 19 L 12-140 14-140, IN 19 LK 10-140 12-140, INX 19 12 14, INX 19 L 12-100 14-100 ITX 19 T55 T60, ITX 19 L T55-100 T60-100, ITX 19 B T50 T55 T60, TX 19 E16 E18 E20 E24	316	390	40	6,9

2005 CT3-32 3/4" SOCKET ASSORTMENT

in 3/4 check tool module,
14 pieces

€377,³¹
+ VAT

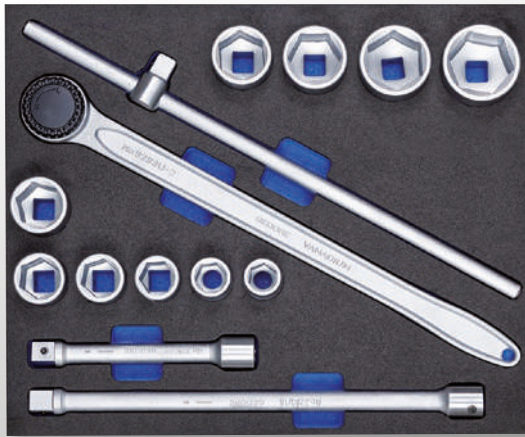

- › Perfect set for hand-operated sockets and connecting parts with square drive
- › With Check-Tool insert for quick check of tool completeness



Code	No.	Contents	Width mm	Depth mm	Pieces	Weight kg
2752727	2005 CT3-32	Socket 3/4" hexagon UD-profile No. 32, 22 24 27 30 32 36 38 41 46 50 Extension 3/4" No. 3290-8 -16 200 mm, 400 mm Reversible ratchet 3/4" No. 3293 U-2, 510 mm Sliding T-bar 3/4" No. 3287	472	390	14	9

2005 CT4-7 XL COMBINATION SPANNER SET

in 4/4 check tool module,
18 pieces

€451,²⁶
+ VAT

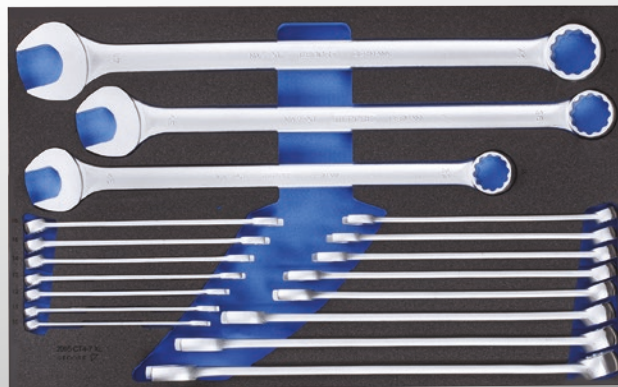

- › Perfect set composition for gentle screw operation
- › Combination spanner extra long for more torque



Code	No.	Contents	Width mm	Depth mm	Pieces	Weight kg
2704226	2005 CT4-7 XL	Combination spanner No. 7 XL, 10 11 12 13 14 15 16 17 18 19 21 22 24 27 30 32 36 41 mm	633	390	18	8,15

2005 CT4-1B COMBINATION SPANNER SET

in 4/4 check tool module,
25 pieces

€432,⁷⁷
+ VAT

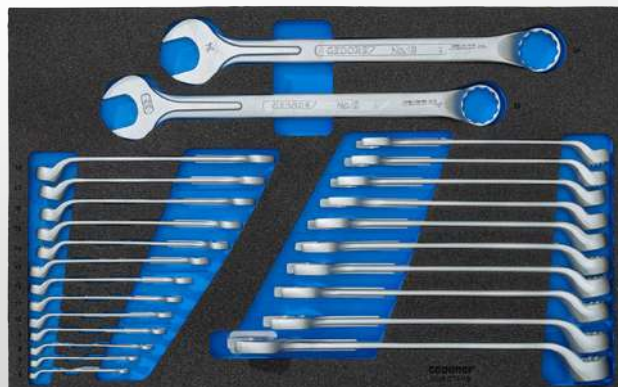

- › Shaft reinforced by power ribs on the jaw side guarantees maximum torque
- › With UD profile for easy power transmission
- › Ring cranked and 10° angled
- › Ideal for countersunk or low-lying nuts and bolts



Code	No.	Contents	Width mm	Depth mm	Pieces	Weight kg
3434982	2005 CT4-1B	Combination spanner no. 1 B, 6 7 8 9 10 11 12 13 14 15 16 17 18 19 20 21 22 23 24 25 26 27 28 29 30 32 34mm	633	390	25	6,2

2005 CT4-8000 TOOL ASSORTMENT

in 4/4 check tool module, 13 pieces

› For removing and installing retaining rings

€293,²⁸
+ VAT



Code	No.	Contents	Width mm	Depth mm	Pieces	Weight kg
2016303	2005 CT4-8000	Engineers' hammer ROTBAND-PLUS No. 600 H-300 -500 Recoilless hammer No. 248 ST-40 Universal pliers No. 142 10 JC Bent nose pliers No. 8132-160 JC Power side cutter No. 8316-160 JC Power combination pliers No. 8250-180 JC Circlip pliers for external retaining rings No. 8000 A 1 2 21 Circlip pliers for internal retaining rings No. 8000 J 1 2 21	633	390	13	4,1

2005 CT4-U-20 1/4"-3/8"-1/2" SOCKET SET

in 4/4 check tool module, 91 pieces

› Extensive 1/4"-3/8"-1/2" set for universal use

€948,⁷⁴
+ VAT

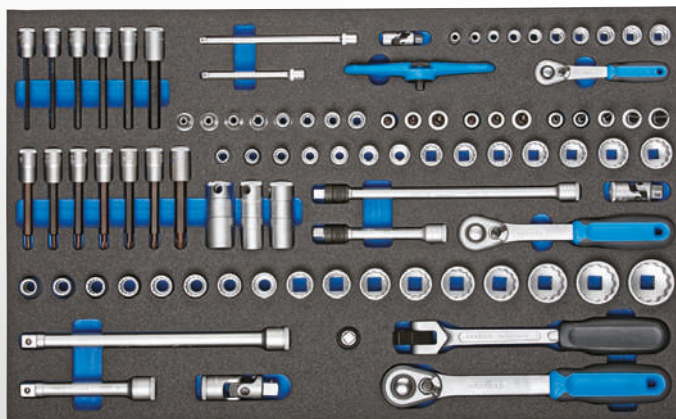

Code	No.	Contents	Width mm	Depth mm	Pieces	Weight kg
2016257	2005 CT4-U-20	1/4" Socket No. 20, 5.5 6 7 8 9 10 11 12 13 14 mm 1/4" Reversible ratchet No. 2093 U-20, 1/4" Cross-handle ratchet No. 2093 U-3 T 1/4" Extension No. 2090-4 -6, 97 148 mm, 1/4" Universal joint No. 2095 3/8" Socket No. D 30, 8 9 10 11 12 13 14 15 16 17 18 19 21 22 mm 3/8" Screwdriver bit socket No. IN 30 L, 4 5 6 7 8 10 3/8" Screwdriver bit socket No. ITX 30 L, T20 T25 T27 T30 T40 T45 T50 3/8" Socket No. TX 30, E5 E6 E7 E8 E10 E11 E12 E14 3/8" Screwdriver bit socket No. IKS 30, 1 2 3 3/8" Screwdriver bit socket No. IKS 30 PZD 1 2 3 3/8" Screwdriver bit insert No. IS 30, 5.5 6.5 8 10 12 mm 3/8" Spark plug insert with retaining spring 20.8 mm 3/8" Spark plug insert with retaining spring 16 mm 3/8" Spark plug insert with retention spring 18 mm 3/8" Reversible ratchet No. 3093 U-20 3/8" Extension with release No. 3090 A-5 -10, 3/8" Universal joint No. 3095 1/2" Socket No. D 19, 10 11 12 13 14 15 16 17 18 19 21 22 23 24 27 30 32 mm 1/2" Reversible ratchet 1/2" No. 1993 U-20, 1/2" Extension 1/2" No. 1990-5 -10, 125 250 mm 1/2" Reducer 1/2" to 3/8" No. 1930, 1/2" Universal joint 1/2" No. 1995 1/2" Swivel handle No. 1996, 255 mm	633	390	91	7,64

GEDORE 

MOBILE AND MODULAR TOOL SOLUTIONS

MOBILITY SELECTION



Bags, cases, and other mobile storage solutions - There are many safe and stable transport solutions for travelling from the factory to site. With WorkMo® and the MIXX&CLICK® system, **GEDORE** offers modular and mobile tool storage solutions.

gedore.com

1110 WMW-3 TOOL TROLLEY WORKMO B3

€1133,⁶¹
+ VAT



- > Consisting of: No. 1110 WM 34, 1110 WM 321, 1110 WMR 23 and 1110 WMHP 3
- > 6 drawers with full extension suitable for GEDORE 1500 ES/1500 CT modules
- > Wooden worktop for assembly work
- > Compatible with Sortimo® interior vehicle fittings and load safety

Code	No.	Width mm	Height mm	Depth mm	Weight kg
2954443	1110WMW-3	845	1.140	550	52,8

1110 WMW-S-03 WORKMO B3 WITH TOOL ASSORTMENT

110 pieces



- > Ideal for large and small maintenance and assembly work
- > Mobile as a complete unit or each module individually portable
- > 6 drawers with full extension suitable for GEDORE 1500 ES/1500 CT modules
- > Light and sturdy aluminum-plastic mix
- > Compatible with Sortimo® interior vehicle fittings and load safety

€1957,¹⁴
+ VAT

Code	No.	Height mm	Width mm	Depth mm	Number of drawers	Pieces	Weight kg
305194	1110WMW S-03	1.140	845	550	6	110	64,3

Contents

Tool trolley No. 1110 WMW-3, GEDORE L-BOXX® 136 No. 1100 L, S-BOXX® B3 No. 1110 WMSB 3
Tool assortment No. 1110 CTB3-01, Tool assortment No. 1110 CTB3-02

1110 WM 321 TOOL BOX MODULE WORKMO B3

2 drawers H6, compartment for L-BOXX® + S-BOXX®

€450,⁴²
+ VAT

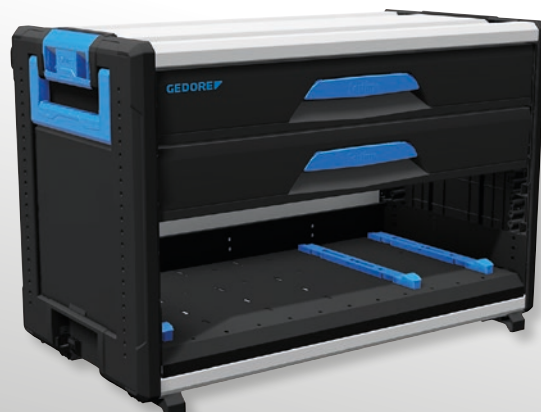

- > 2 drawers with full extension suitable for GEDORE 1500 ES/1500 CT modules
- > Compatible with Sortimo® interior vehicle fittings and load safety
- > Load capacity per drawer 60 kg

Code	No.	Width mm	Height mm	Depth mm	Weight kg
2954354	1110WM 321	789	506	396	22,12

1110 WMHP 3
WOOD PLATE
FOR WORKMO B3

€135,²⁹
+ VAT



- > 20 mm thick laminated beech wood worktop
- > It is placed by clicking on the WorkMo Boxes B2 drawers to get a flat work surface

Code	No.	Width mm	Height mm	Depth mm	Weight kg
2954370	1110 WMHP 3	835	41	426	4,5

1110 WMR 34
ROLLER FOR WORKMO B3
for WorkMo W3

€197,⁴⁸
+ VAT

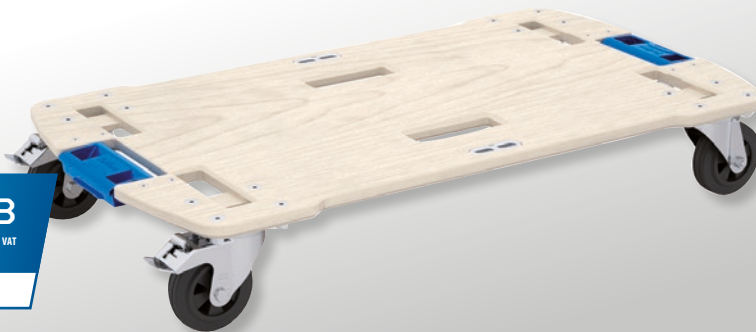

- > Makes the tool box modules mobile
- > Compatible with Sortimo® interior vehicle fittings and load safety
- > Load capacity: 200 kg

Code	No.	Width mm	Height mm	Depth mm	Weight kg
3002713	1110 WMR 34	854	144	493	9

1110 WMW-2
TOOL TROLLEY
WORKMO B2

€814,²⁹
+ VAT



- > Consisting of: No. 1110 WM 24, 1110 WM 221, 1110 WMR 23 and 1110 WMHP 2
- > 6 drawers with full extension suitable for GEDORE 1500 ES/1500 CT modules
- > Wooden worktop for assembly work
- > Compatible with Sortimo® interior vehicle fittings and load safety

Code	No.	Width mm	Height mm	Depth mm	Weight kg
2954435	1110 WMW-2	580	1.140	550	42,6

1110 WMW-5-02 WORKMO B2 WITH TOOL ASSORTMENT

72 pieces



- › Ideal for large and small maintenance and assembly work
- › Mobile as a complete unit or each module individually portable
- › 6 drawers with full extension suitable for GEDORE 1500 ES/1500 CT modules
- › Light and sturdy aluminum-plastic mix
- › Compatible with Sortimo® interior vehicle fittings and load safety

€1192,44
+ VAT

Code	No.	Height mm	Width mm	Depth mm	Contents	Number of drawers	Pieces	Weight kg
3005186	1110 WMW S-02	1.140	580	550	Tool trolley no. 1110 WMW-2 GEDORE L-BOXX® 136 No. 1100 L Tool assortment No. 1110 CTB2-01 Tool assortment No. 1110 CTB2-02	6	72	50,5

1110 WM 221 TOOL BOX MODULE WORKMO B2

2 drawers H6, compartment for L-BOXX®

€315,13
+ VAT

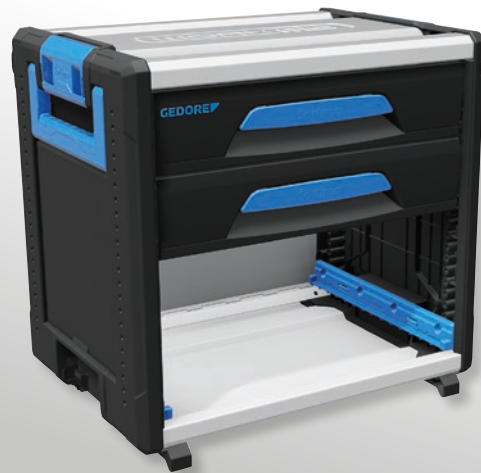

- › 2 drawers with full extension suitable for GEDORE 1500 ES/1500 CT modules
- › Compatible with Sortimo® interior vehicle fittings and load safety
- › Load capacity per drawer 30 kg

Code	No.	Width mm	Height mm	Depth mm	Weight kg
2954338	1110 WM 221	526	396	506	15,26

1110 WMHP 2 WOOD PLATE FOR WORKMO B2

€90,67
+ VAT



- › 20 mm thick laminated beech wood worktop
- › It is placed by clicking on the WorkMo Boxes B2 drawers to get a flat work surface

Code	No.	Width mm	Height mm	Depth mm	Weight kg
2954362	1110 WMHP 2	572	41	426	4,5

1110 WMR 24 ROLLER FOR WORKMO B2



€152,⁹⁴
+ VAT

- › Makes the tool box modules mobile
- › Compatible with Sortimo® interior vehicle fittings and load safety
- › Load capacity: 200 kg

Code	No.	Width mm	Height mm	Depth mm	Weight kg
3002721	1110 WMR 24	612	144	493	8

1335 L TOOLKIT 5 compartments, long pattern

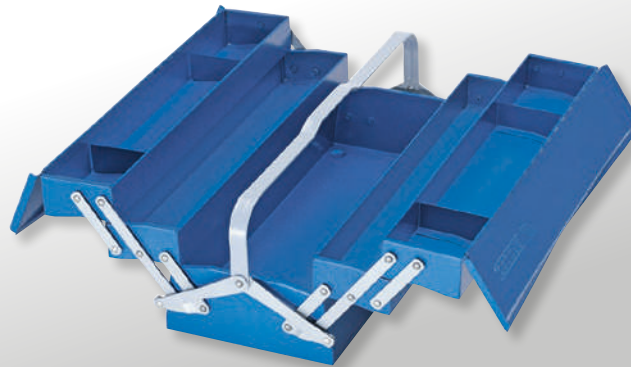

€135,²⁹
+ VAT

- › Great extendability of the tool compartments
- › Great stability even if only one side is opened
- › Particularly suitable for ranges No. S 1024, S 1025, S 1151 and S 1151 A

Code	No.	Height mm	Width mm	Depth mm	Weight kg
6610580	1335 L	210	535	225	6,84

1041-002 PROFI-TOOL ASSORTMENT IN CASE 100 pieces



€803,³⁶
+ VAT

- › Professional set for all trades
- › Practical compilation for mobile use
- › Robust companion - whenever the right tools have always to be at hand

Code	No.	Contents	Width mm	Height mm	Depth mm	Pieces	Weight kg
3082148	1041-002	Combination spanner No. 1 B, 8 10 13 17 19 22 mm, 1/2" Socket No. 19, 8 10 13 17 19 22 mm 1/2" Extension No. 1990-5, 1/2" Reversible ratchet No. 1993 U-20 Spring Socket rail for 14 inserts 1/2" VH 19, 1/4" Bit socket box No. 666-U-20, with ratchet 35 pcs Allen Key set No. H 42-10, in holder 10 pcs, Offset screwdriver set TX No. H 43 TX-88 in holder 8 pcs Adjustable open-end wrench No. 60 P 8, 8" Percussion tool set No. 106, 6 pcs., Grip pliers No.137 10, 10" Square awl No. 156 S, Non-return soft-face and engineer's hammer KOMBI-PLUS R No. 247 H-30 Hobby saw No. 406, Cable knife No. 0513-09 Spark plug brush No. 647, Pocket caliper No. 710 3C-Screwdriver slotted No. 2150, 3 4 5.5 6.5 8 mm 3C-Screwdriver philips No. 2160, PH 0 1 2 3C-Screwdriver pozi No. 2160, PZ 1 2 Steel tape measure No. 4534-3, tape L. 3 m Voltage detector slotted No. 4615 3, 220-250 V, 3mm Small universal scissors No. 8096-140 Wire stripper No. 8098-160 JC, 160 mm 2C-handle Multiple pliers No. 8133-200 JC, 200 mm 2C-handle Combination pliers 8245-180 JC, 180 mm 2C-handle Power side cutter No. 8316-160 JC, 160 mm 2C-handle Universal pliers No. 142 10 TL, 10" + Tool case No. WK 1041 L	490	185	395	100	12,9

1090 TOOL CASE ELECTRICIAN

87 pieces

› The perfect tool set for the electrician or property manager



6,3 1/4 mm

Code	No.	Contents	Width mm	Height mm	Depth mm	Pieces	Weight kg
6601590	1090	6 14x17 18x19 21x23 22x24 8-011 Double open-end spanner set 11 pieces 4,5-13mm D 20 TMU-10 Socket set 1/4" 40 pieces UD-IN-IS-PH-PZ-TX H 42-10 Allen Key set in holder 10 pieces 1,3-10mm 183 10 TC Pliers wrench 10", 142 10 TL Universal pliers 10" 15-way adjustable dip-insulated VDE 2162 PZ 1 2, VDE 2162 PH 1 2, VDE 2172 3,5 4,0 5,5 6,5, 406 Hobby saw 746 Carbide scriber, 4528 Cable knife, 4534-3 Steel tape measure 3 m VDE 4616 Voltage tester 2-pole 1000V LED display VDE 8098-160 H VDE Wire stripper with sleeve insulation 160 mm VDE 8250-180 H VDE Power combination pliers with sleeve insulation 180 mm VDE 8131 AB-200 H VDE Multiple pliers 200mm gewinkelt with sleeve insulation VDE 8316-200 H VDE Power side cutter 200 mm, sleeve insulation 95-175 Flat chisel flat oval, 175x20x12 mm 600 H-300 Engineer's hammer ROTBAND-PLUS with hickory handle, 300 g 45 S Multi fitting key Universal WK 1041 L Tool case large empty	490	185	395	87	13,155

1000 TOOL CASE TOURING

49 pieces

› Compilation with the most important tools for common screwdriving and assembly work
 › Robust plastic case for safe transport
 › Clearly arranged in check tool inserts



12,5 1/2 mm

Code	No.	Width mm	Height mm	Depth mm	Pieces	Weight kg
6600780	1000	435	100	385	49	7
Contents Combination wrench No. 7 6 7 8 10 11 12 13 14 15 17 19 mm, 1/2" socket wrench insert 6kt No.19, 10 11 12 13 14 15 17 19 22 mm Extension 1/2" No. 1990-5 -10, 125 250 mm, Cardan joint 1/2" No. 1995, 73,5 mm, reversible ratchet 1/2" No. 1993 U-20, 270 mm Offset screwdriver set No. PH 42-88, 2-10 mm in holder 8 pcs, 3C-Screwdriver slot No. 2150, 4 5.5 6.5 mm 3C-Screwdriver Cross-recess No. 2160 PH 1 2, Voltage tester 220-250 V, slot No. 4615 3, 3 mm Cable knife No. 0513-09, 195 mm, Universal Pliers No. 142 10 TL, 10" Power side cutter No. 8316-160 JC, 160 mm 2C handle, Multiple Pliers No. 8133-180 JC, 180 mm 2C-Handle Engineer's hammer ROTBAND-PLUS No. 600 H-300, 300 g, Percussion tool set No. 106, 6-piece in PVC holder No. 106 + Case WK 1000 L						

1100-01
**GEDORE L-BOXX® 136
 WITH CRAFTSMAN
 ASSORTMENT**

58 pieces



- > Especially suitable for the handyman or DIY enthusiast
- > Practical compilation for mobile use
- > With Check-Tool insert for quick check of tool completeness
- > GEDORE L-BOXX® 136 with Easy Click connection system

€450,42
 + VAT



Code	No.	Width mm	Height mm	Depth mm	Pieces	Weight kg
2658194	1100-01	444	152	360	58	9,5
Contents						
1/2" reversible ratchet No. 1993 U-20, 1/2" extension No. 1990-10, 250 mm, 1/2" universal joint No. 1995						
1/2" socket wrench insert No. 19, 10 11 12 13 14 15 16 17 18 19 21 22 24 mm, Adjustable open-end wrench No. 60 CP 8, 8"						
Universal Pliers No. 142 10 JC, 10", 2C handle power side cutter No. 8316-160 JC, 160 mm, 2C handle Multiple Pliers No. 8133-180 JC, 180 mm						
2C handle engineer's hammer No. 600 H-500, 500 g, Bricklayer's chisel No. 110-256, 250x16 mm						
Control cabinet key UNIVERSAL No. 45 S, for control cabinets and locks, Miniature LED light No. TFK 649						
Hinged base No. E-649 F for LED light No. TFK 649, Cable knife No. 0063-08, blade L. 80 mm						
Offset screwdriver set No. H 42-10, hexagon 1.3 1.5 2 2.5 3 4 5 6 8 10 mm, Offset screwdriver No. SCL 43 TX-80, T9 T10 T15 T20 T25 T30 T40						
VDE Screwdriver set No. VDE 2170-2160 PH-077 Slot 2.5 4 5.5, cross recess PH 0 1 2, Voltage Detector Slot No. 4615 3, 220-250 V, 3mm						
Wooden folding rule No. 4533-2, 2 m, Warding file set No. 8728, flat file, triangular, square, half-round, round file						
+ GEDORE L-BOXX® 136 No. 1100 L						

905
ROLLER BOARD

€72,26
 + VAT



- > Made of PP (polypropylene) - resistant to oils, greases and brake fluid
- > Fatigue-free working, with head/neck cushion for maximum comfort
- > Bucket moulding gives additional hold and allows maximum freedom of movement
- > Load capacity 130 kg

Code	No.	Length mm	Height mm	Width mm	Weight kg
1823698	905	1.000	120	480	5

906
KNEELING BOARD

€11,76
 + VAT

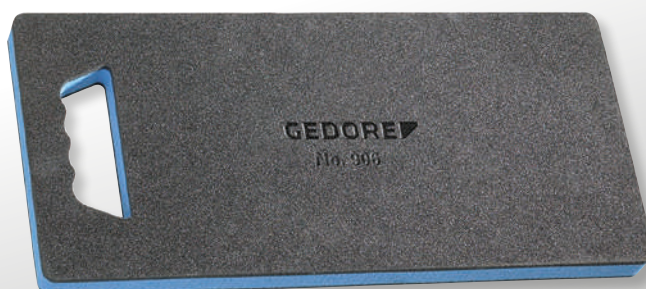

- > Made of solid foam, blue/black
- > With recessed grip

Code	No.	Length mm	Height mm	Width mm	Weight kg
1942948	906	450	30	210	0,11

120 WRECKING BAR

> Made of special steel

from **€16,²⁹**
+ VAT



Code	No.	Length mm	Hexagonal	Weight kg	excl. VAT
8769410	120-500	500	18 mm	1,15	16,29
8769920	120-1000	1.000	18 mm	2,175	20,83

640-1800 MAGNETIC LIFTER

- > With flexible shaft and plastic handle
- > For picking up and holding small magnetic parts
- > Easy handling due to flexible shaft



Code	No.	Total length mm	Magnet diameter	Magnetic lifting force g	Weight kg
6531280	640-1800	520	12,0	1.800	0,23

8551 S-005 BOLT EXTRACTOR SET

5 pieces



- > For removing broken screws, bolts and tube ends
- > Minimum extraction force torque thanks to the new cross-sectional geometry
- > Reduced drilling depth thanks to an optimised thread length

€19,⁹¹
+ VAT

Code	No.	Contents	Width mm	Height mm	Pieces	Weight kg
2659336	8551 S-005	8551 S Bolt extractor M3-M6 M6-M8 M8-M11 M11-M14 M14-M18	52	15	5	0,125

133 K GASKET SCRAPER

- > Ergonomic 3-component handle Power-Grip³ for maximum power transmission with minimum stress on the hand
- > Ideal for removing plaques, sealant and adhesive residues

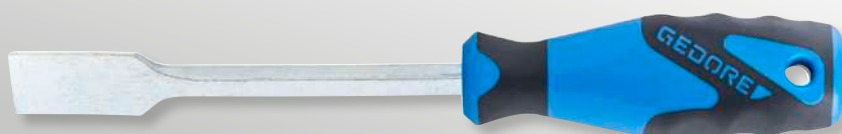

€17,²²
+ VAT

Code	No.	Blade width	Total length mm	Weight kg
6535190	133 K	22,5	240	0,154

407
HACKSAW



- > For severing metals and steel
- > To best serve the intended purpose, the saw blade can be used both vertically and at a 40° angle
- > Practical, tool-free clamping function of the saw blade due to blue clamping element in the handle
- > Bimetal saw blade 407 A

€27,¹³
+ VAT

Code	No.	Blade length mm	Weight kg
1879375	407		0,66

36 2-200
STRAP WRENCH

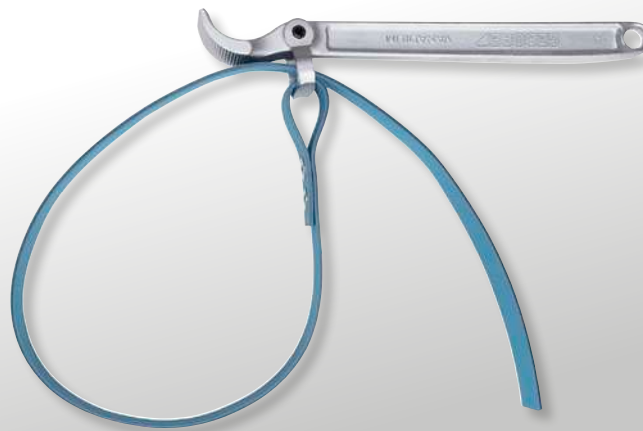

- > With strong, non-slip fabric strap (E-36)
- > Extra wide = 25 mm

€43,³⁵
+ VAT

Code	No.	for Ø mm	for Ø inch	Total length mm	Tape width mm	Weight kg
6327400	36 2-200	200	8"	295	25	0,578

1.04/HP2A-B
UNIVERSAL PULLER
HIGH POWER

2-arm pattern,
rigid legs with leg brake



- > Spreader beam specially hardened and tempered, load with double traction force possible
- > Puller legs forged from one piece, therefore more accurate fit, more stable, safer
- > With leg brake
- > Adjustment scale for even adjustment of the puller hooks

€171,⁴³
+ VAT

Code	No.	Clamping width (max.) external pulling mm	Clamping width (min.) internal pulling mm	Clamping width a2 (max.) internal pulling mm	Usable clamping reach mm	Tractive force (max.) t	Spindle thread size	Width across flats mm	Width of hooked foot mm	Usable depth of hooked foot mm	Thickness of hooked foot at tip	Graduation	Weight kg
1981153	1.04/HP2A-B	200	110	260	150	10	G1/2x 210mm	22 mm	30	24	3,5	x	3,4

NEW

PULLER FOR HIGH PULLING FORCES

Minimum energy required for the user with hydraulic support.

The **2-arm puller 1.04/HP2A-B-HSP1-S** from GEDORE is ideal for both stationary and mobile applications. The safer and higher stressable components prevent slipping during the work process and increase work safety. One-piece forged rigid legs can be quickly adjusted, whereby the clamping reach, especially in mobile use, can be quickly and easily adapted to all challenges. Higher forces can be easily and safely applied by using the hydraulics. The protective layer rounds off the universally usable puller's safety concept.

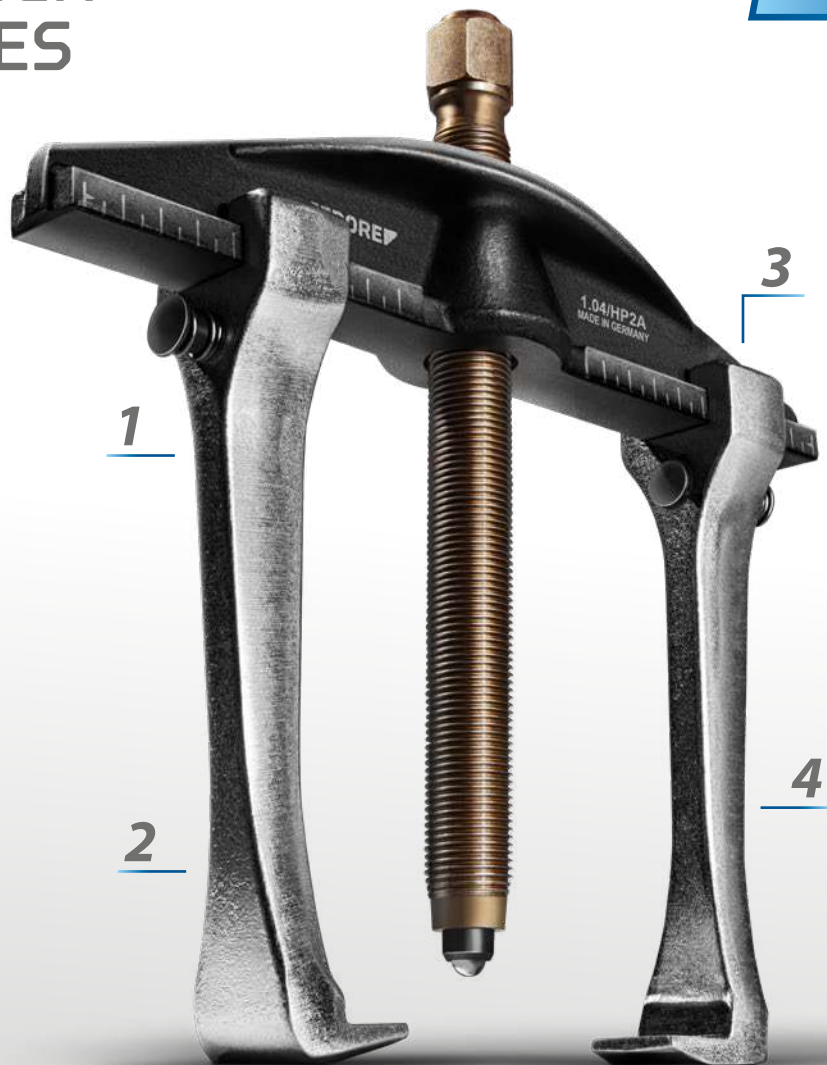

2-arm high power including hydraulics & protective layer – 1.04/HP2A-B-HSP1-S

1

EFFORTLESS REMOVING,
LESS ENERGY REQUIRED

2

INCREASED SAFETY AND
DURABILITY THANKS TO
HIGHER STRESSABLE
COMPONENTS

3

QUICK ADJUSTMENT
OPTION

4

PROTECTIVE LAYER
PROTECTS PEOPLE
AND MACHINE



PULLING MADE
EASY

1.04/HP2A-B-HSP1-S
2-ARM HIGH POWER
 incl. hydraulics & protective foil



€461,34
 + VAT

- > Safe, highly stressable components
- > External puller with innovative high power components for twice the load capacity
- > External puller with rigid legs, quick adjustment
- > Effortless pulling with grease hydraulics
- > Includes protective layer

Code	No.	Contents	Max. clamping depth mm	Max. Span mm	Hook foot thickness mm	Total hook base depth mm	Weight kg
3461815	1.04/HP2A-B-HSP1-S	1.04/HP2A-B Puller HIGH POWER 2-arm span width 200 mm x span depth 150 mm 1.06/HSP1 Hydraulic pressure spindle for 1/2" thread, 10 t max.load 5.10 Safety cover 510 mm x 915 mm	159	202	3,5	34	6

1.04/ST
PULLER-SET
 with stand



- > Strong drop forged pattern
- > Due to the bending-moment reinforcement on its back face, the energy-saving design of the cross-beam means even stronger and safer pulling work
- > Adjustment scale for even adjustment of the pull-off hooks
- > The quick-action adjustment feature supports the energy-saving and fast operation

€486,55
 + VAT

Code	No.	Contents	Span mm	Clamping depth mm	Weight kg
1675982	1.04/ST	1.04/1A Universal puller 2-arm 130x100 mm 1.04/2A Universal puller 2-arm 200x150 mm 1.04/3A Universal puller 2-arm 350x200 mm 1.04/97 Stand empty for 1.04-Series	130 200 350	100 150 200	15,2

THE VERSATILE POWER AMPLIFIER FOR PULLING WORK

The universal and powerful grease hydraulic pressure spindle for pulling extremely tight-sitting components.

The **grease hydraulic pressure spindle 1.06/HSP1** from GEDORE is ideal for stationary and mobile applications. High compressive forces of up to 10 t can be applied quickly, easily and safely with little physical energy required. Tight-sitting bearings, gearwheels or discs can then be efficiently removed. 1/4" socket or

torque tool at hand is used with it. The thrust piece can be replaced by a tip and extended as required – highest work safety, as unsafe underlays are no longer necessary.

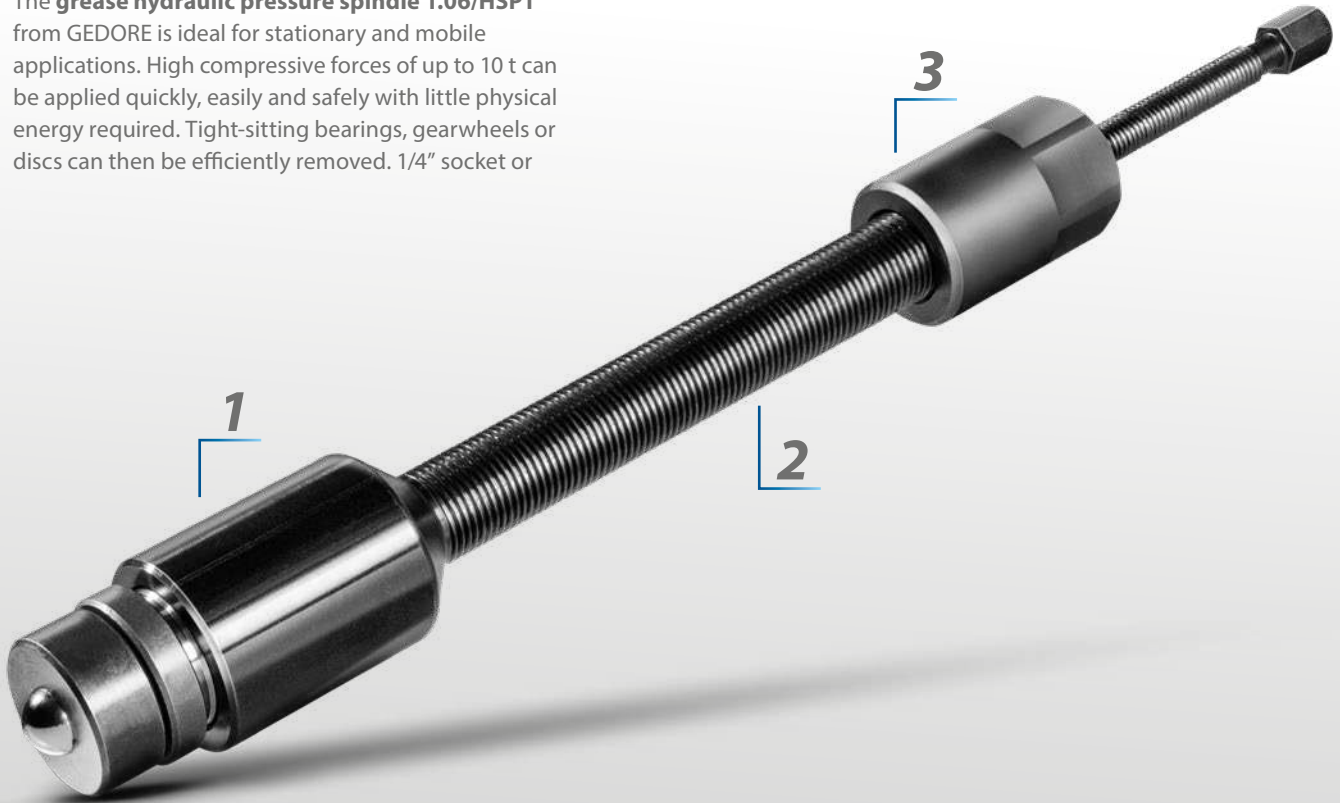

Grease hydraulic pressure spindle – 1.06/HSP1

1

HYDRAULIC POWER TRANSMISSION FOR COMPRESSIVE FORCES UP TO 10 T

2

EASY AND INTUITIVE USE WITH STANDARD 1/4" SOCKET OR TORQUE TOOL

3

CONTROLLED AND SAFE PULLING

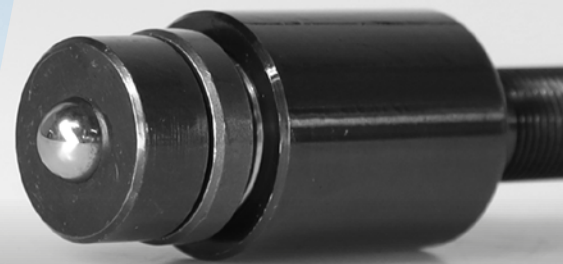

*POWERFUL
SPINDLE*



1.06/HSP1
HYDRAULIC PRESSURE
SPINDLE

- > For controlled and safe pulling work
- > Can be used in any puller with a suitable 1/2" thread
- > The thrust piece can be replaced by a tip and extended if necessary
- > The small pressure spindle is secured with an unscrewing lock to stop any accidental withdrawal



€252,94
+ VAT

Code	No.	Spindle thread size	Power of pressure	Compressive force Nm	Head height 1 mm	Usable thread length mm	Length mm	Width across flats 1 mm	Width across flats 2 mm	Stroke	Weight kg
8116100	1.06/HSP1	G 1/2"	10,0	17,0	80	135	350	12	32	12	1,1



1.06/AS
PULLER-SET
 with 6 legs

€221,⁰¹
 + VAT



- › 2-arm puller, with 6 slender legs in 3 lengths
- › Particularly suitable for hard-to-reach areas

Code	No.	Contents	Span mm	Clamping depth mm	max. t	Weight kg
8001710	1.06/AS	106/1A03 Cross-beam 2-arm 180 mm 106/A-100-S Pulling leg slim 100 mm (2x) 106/A-200-S Pulling leg slim 200 mm (2x) 106/A-250-S Pulling leg slim 250 mm (2x) E-1.1406140 Spindle 17, M14x1,5, 140 mm	130 130 130	100 200 250	2,5	3,4

1.07/2A1-B
UNIVERSAL PULLER
 3-arm pattern,
 rigid legs with leg brake

€166,³⁹
 + VAT



- › Even load distribution over 3 legs ensures secure grip and balanced pull
- › Puller legs forged from one piece, therefore more accurate fit, more stable, safer
- › With leg brake
- › Can be used as external and internal puller by repositioning the legs
- › Interchangeable hooks available for several clamping depths

Code	No.	Clamping width (max.) external pulling mm	Clamping width (min.) internal pulling mm	Clamping width (max.) internal pulling mm	Usable clamping reach mm	Tractive force (max.) t	Spindle thread size	Width across flats mm	Width of hooked foot mm	Usable depth of hooked foot mm	Thickness of hooked foot at tip	Weight kg
1957988	1.07/2A1-B	200	100	260	150	5	G 1/2 x 210	22	30	24	3,5	3,7

1.10/1
PULLER
 2-arm pattern

€54,¹⁹
 + VAT



- › Tried and tested, strong design for removing discs, wheels, ball bearings etc.
- › The wide or narrow hook ends, which can be used on both sides, press themselves automatically when loaded

Code	No.	Clamping width (max.) external pulling mm	Usable clamping reach mm	Tractive force (max.) t	Spindle thread size	Width across flats mm	Width of hooked foot mm	Usable depth of hooked foot mm	Thickness of hooked foot at tip	Weight kg
8002600	1.10/1	90	80	2	M 14x1,5 x 125	17	17	7	2,0	0,7

1.11/1
PULLER
 3-arm pattern

€67,⁸¹
 + VAT



- › Tried and tested, strong design for removing discs, wheels, ball bearings etc.
- › The wide or narrow hook ends, which can be used on both sides, press themselves automatically when loaded

Code	No.	Clamping width (max.) external pulling mm	Usable clamping reach mm	Tractive force (max.) t	Spindle thread size	Width across flats mm	Width of hooked foot mm	Usable depth of hooked foot mm	Thickness of hooked foot at tip	Weight kg
8002950	1.11/1	90	80	3	M 14x1,5 x 125	17	17	7	2,0	0,9

1.23/2
PULLER
 with slim legs

€99,¹⁶
 + VAT



- › For extraction from the bearing in spaces that are difficult to access
- › The legs grip automatically

Code	No.	Clamping width (max.) external pulling mm	Usable clamping reach mm	Tractive force (max.) t	Spindle thread size	Width across flats mm	Width of hooked foot mm	Usable depth of hooked foot mm	Thickness of hooked foot at tip	Weight kg
8084660	1.23/2	120	120	3.5	M 14x1,5 x 130	17	31	5	3,5	0,8

1.18/1.19 PULLER-SET

12 pieces

- › For clamping depths from Ø 200 mm and clamping reach up to 200 mm
- › Delivery includes perforated panel



Code	No.	Contents	Pieces	Weight kg
1824007	1.18/1.19	1.18/1 Puller 2-arm 110x110 mm, 1.18/2 Puller 2-arm 160x140 mm 1.18/3 Puller 2-arm 200x200 mm, 1.18/02 Pole terminal remover 2-arm 65x50 mm 1.18/01 Pole terminal remover 2-arm 70x70 mm, 1.18/0 Pole terminal remover 2-arm 80x80 mm 1.19/1 Puller 3-arm 110x110 mm, 1.19/2 Puller 3-arm 160x140 mm 1.19/3 Puller 3-arm 200x200 mm, 1.19/02 Pole terminal remover 3-arm 65x50 mm 1.19/01 Pole terminal remover 3-arm 70x70 mm, 1.19/0 Pole terminal remover 3-arm 80x80 mm 1500 H 1 Tool hook inclined hook end d 4 mm (12x), 1500 H 2-13 Tool clamp d 13 mm (6x) 1450 L Tool board empty, 987x493 mm	12	21

1.31 INTERNAL EXTRACTOR SET

- › Sets comprise the most used extractor sizes for the removal of ball bearings, bearing races, bushings, shaft seals, etc.

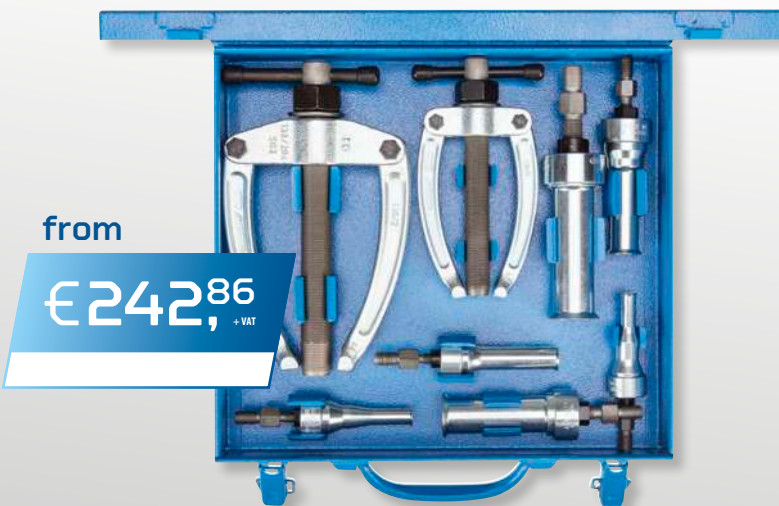

1.31/0



1.31/1

from
€242,86
+ VAT

Code	No.	Contents	Pieces	Weight kg	excl. VAT.
8014530	1.31/0	1.30/2 Internal extractor 12-15 mm 1.30/3 Internal extractor 15-19 mm 1.30/4 Internal extractor 19-25 mm 1.30/4A Internal extractor 25-30 mm 1.36/1 Counter support for 1.30/0 - 1.30/5 131/099B Sheet metal case empty	5	2,6	242,86
8014610	1.31/1	1.30/2 Internal extractor 12-15 mm 1.30/3 Internal extractor 15-19 mm 1.30/4 Internal extractor 19-25 mm 1.30/4A Internal extractor 25-30 mm 1.30/5 Internal extractor 30-35 mm 1.30/6 Internal extractor 35-45 mm 1.36/1 Counter support for 1.30/0 - 1.30/5 1.36/2 Counter support for 1.30/6 - 1.30/7 131/199B Sheet metal case empty	8	6,4	378,15

1.26/HYD
NUT SPLITTER
 hydraulic

€143,⁷⁰
 + VAT



- › The chamfer at the chisel's edge improves the splitting effect and prevents breakage
- › With smooth chisel function
- › For nuts up to property class 10
- › Chisel replaceable

Code	No.	for nuts of size	Width across flats mm	Weight kg
8009450	1.26/1 HYD	M4 - M14	12	0,8

1.81/K-12
THREAD ADAPTOR SET
 for 1-hole uses

€125,²¹
 + VAT



- › The threaded inserts make the removal of threaded caps, for example, possible, when these possess one threaded hole
- › No. 1.81/K-1: With slide hammer No. 1.35/1, bar 230 mm and impact weight 200 g

Code	No.	Contents	Length mm	Width mm	Height mm	Weight kg
1936557	1.81/K-12	1.35/1A Sliding hammer 270 mm, 700 g, 181/101 Threaded insert M10 / M4 181/102 Threaded insert M10 / M5, 181/103 Threaded insert M10 / M6 181/104 Threaded insert M10 / M8, 181/105 Threaded insert M10 / M10 181/106 Threaded insert M10 / M12, 181/210 Threaded insert M14x1,5 / M14 181/211 Threaded insert M14x1,5 / M16, 181/212 Threaded insert M14x1,5 / M18 135/125-II Adapter M10 - M14x1,5, 181/1299 Plastic case with foam insert	270	230	84	1,83

1.07/K-2-SE
PULLER-SET
 with 3 legs

€324,³⁷
 + VAT



- › Small handy set for 2&3 arm application in hard to reach places
- › Slim leg feet

Code	No.	Contents	Spannweite Sätze	Spanntiefe Sätze	Tractive force (max.) [t]	Weight kg
1645455	1.07/K-2-SE	106/203 Cross-beam 2-arm 220 mm, 107/203 Cross-beam 3-arm 220 mm 106/B-150-SE Pulling leg with with quick release clamp 150 mm (3x) 1.2106210 Spindle 22, G 1/2", 210 mm 107/299-SE Plastic case with foam insert for 1.07/K-2-SE	160	150	5,0	5,5

INTUITIVE AND SAFE HANDLING

For removing ball bearings sitting on a shaft and in a housing at the same time.

The **ball bearing extractor set 1101 -1.29/1K** from GEDORE with more than 30 sizes is the perfect basic equipment set for every user.

The user-oriented design guarantees fault-free use without the danger of slipping or slanted pulling and meets the highest work safety requirements. The optimised hook shape guarantees safe holding and spacers directly on the hook mean no

additional support rings are required. The standard i-BOXX® ensures safe storage and is compatible with the GEDORE MIXX & CLICK concept – flexible and mobile use.

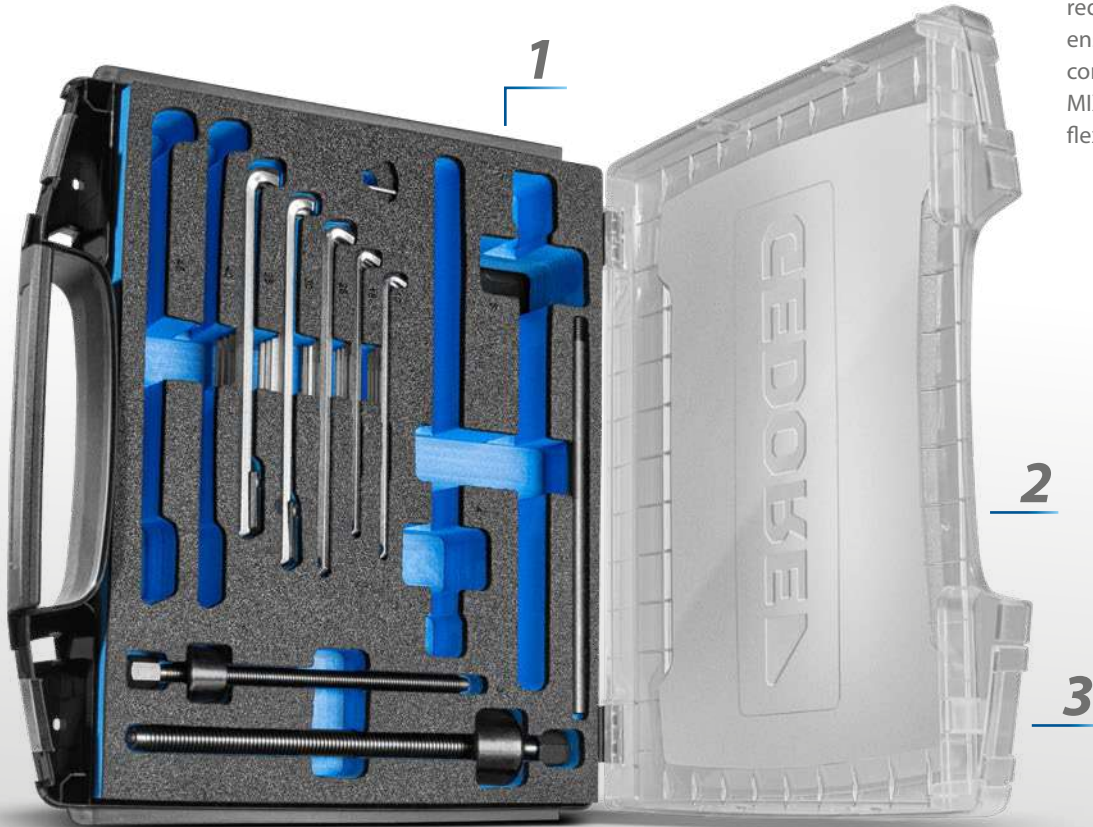

Ball bearing extractor set in GEDORE i-BOXX® – 1101 -1.29/1K

1

EXTENSIVE BALL BEARING EXTRACTOR SET FOR MORE THAN 30 SIZES

2

SYSTEM-COMPATIBLE: GEDORE MIXX & CLICK AND SORTIMO IN-VEHICLE EQUIPMENT

3

SLIPPING OR SLANTED PULLING NOT POSSIBLE





1101-1.29/1K

BALL BEARING EXTRACTOR SET

in i-BOXX® 72

- > Ball bearing puller set for over 30 ball bearings
- > For removing ball bearings that sit on a shaft and in a housing at the same time
- > Non-destructive removal of deep groove ball bearings without removing the shaft, no need to drill out the bearing cage (chip-free)

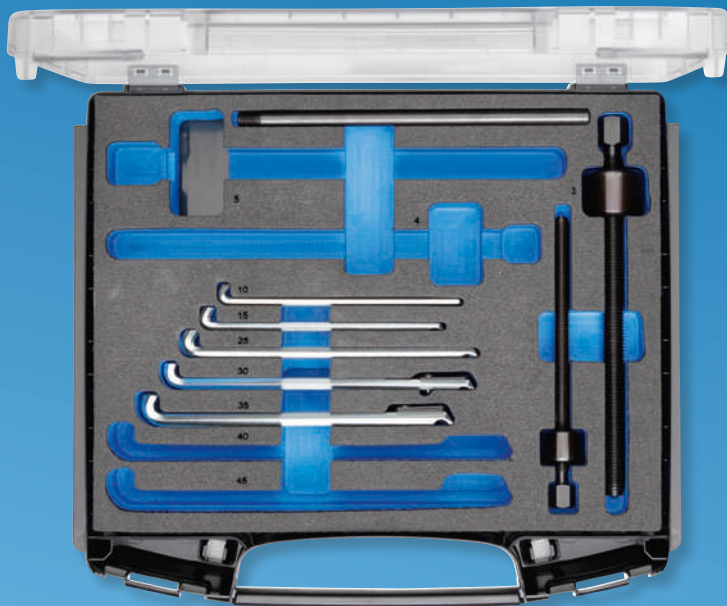

€432,77
+ VAT

Code	No.	Use	Contents	Width mm	Height mm	Depth mm	Weight kg
2963485	1101-1.29/1K	6000 6001 6002 6003 6005 6006 6007 6008 6009 6010 6011 6012 6200 6201 6202 6203 6204 6205 6206 6207 6300 6301 6302 6303 6304 6305 6306 6307 6403 6404	129/104 Head 129.106 Spindle 14, M10x1,5, 160 mm 129/304 Head, 129.306 Spindle 17, M14x2,0, 210 mm 129/10 Pulling leg 1 pcs. 140 mm (4x) 129/15 Pulling leg 1 pcs. 140 mm (4x) 129/25 Pulling leg 1 pcs. 170 mm (4x) 129/30 Pulling leg 1 pcs. 178mm with 3 spacers (4x) 129/35 Pulling leg 1 pcs. 178mm with 5 spacers (4x) 1.29/0 Plug-in handle burnished EI-1101 CT-1.29/3K Foam insert i-BOXX 72, empty 1101 L GEDORE i-BOXX 72 empty	367	72	316	2,61

1101-1.04/SEB-08
**PULLER SET,
 2-ARM PATTERN**
 9 pieces

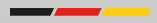

- > For loosening seized connections on shafts or in housings
- > As a result of possible clamping reaches continuously up to 130 mm / clamping depths 100, 200, 250, 350 mm
- > Variable, rapid and safe working thanks to quick-clamp mechanism, leg brake, leg for confined spaces
- > 8 different pullers can be combined

 Made in Germany

Code	No.	Contents	Width mm	Height mm	Pieces	Weight kg
3106756	1101-1.04/SEB-08	i-BOXX 72 No. 1101 L + Assortment No. 1101 CT2-1.04	316	72	9	3,77

1100-1.04/12A
**PULLER ASSORTMENT
 INSIDE/OUTSIDE**
 in L-BOXX® 136

€568,07
 + VAT



- > Max. capacity 3 and 5 t
- > For clamping widths up to Ø 200 mm external, Ø 70-260 mm internal, and clamping depths up to 300 mm
- > Quick release hook with self-supporting T-profile for better power transmission
- > 2 steel extensions each 100 and 150 mm with leg brake for quick adjustment of the legs

Code	No.	Contents	Width mm	Height mm	Depth mm	Weight kg
2927241	1100-1.04/12A	Universal puller No. 1x 1.04/1A, 2-arm 130x100 mm Universal puller No. 1.04/2A 2-arm 200x150 mm Extension with hook brake No. 106/A-100-VB, 100 mm Extension with hook brake No. 106/B-150-VB, 150 mm Spindle No. 1.1406200 17 M14x1,5 200 mm Spindle No. 1.2106350KS, 22, G 1/2", 350 mm, with ball point + GEDORE L-BOXX® 136 No. 1100 L	444	152	360	9,6



NEW

COMPACT AND HANDY SET IN I-BOXX

The compact set for pulling ball bearings, bushings or other components inside the housing.

The **internal puller set with counter supports & slide hammer 1101-1.31/0-H** from GEDORE, with internal pullers, counter supports

and slide hammer, is ideal for stationary and mobile use. The compact i-BOXX (W x D x H: 340 x 260 x 60 mm) guarantees safe storage and ensures maximum flexibility.

Depending on the power required for pulling, the set's combination offers a wide range of usage areas – no further additional tools are necessary.



Internal puller set with counter supports & slide hammer – 1101-1.31/0-H

1 COMPACT SET OF INTERNAL PULLERS, COUNTER SUPPORTS AND SLIDE HAMMER

2 CHECK-TOOL INSERT FOR MOBILE AND STATIONARY USE

3 FLEXIBLE USE WITH SLIDE HAMMER AND COUNTER SUPPORTS



*SMALL SET -
BIG EFFECT*



NEW

1101-1.31/0-H
**INTERNAL
 EXTRACTOR SET**
 with counter support & slide
 hammer in i-BOXX

€368,⁹¹
 + VAT



- > Compact and handy set consisting of internal pullers, counter supports & slide hammer
- > Compact and handy i-BOXX ideal for both mobile and stationary use
- > Check-Tool insert fits into the L-BOXX and tool trolleys/workbenches with minimum drawer dimensions 340 x 260 x 60 mm
- > Check-Tool insert for quick missing tool check

Code	No.	Contents	Length mm	Width mm	Height mm	Pieces	Weight kg
3461734	1101-1.31/0-H	1.30/1 Internal extractor for Ø 8-12mm 1.30/2 Internal extractor for Ø 12-15 mm 1.30/3 Internal extractor for Ø 14-19 mm 1.30/4 Internal extractor for Ø 19-25 mm 1.30/4A Internal extractor for Ø 24-30 mm 1.36/1 Counter support for 1.30/0 - 1.30/5 1.35/1A Sliding hammer 700g for 1.30/0 - 1.30/5 1101 L GEDORE i-Boxx 72 Small parts case EI-1101 CT-1.31/0-H Check-Tool-Module, empty	367	316	72	8	3,5

NEW

EXTENSIVE SET FOR ALMOST ALL THE MOST COMMON AREAS OF APPLICATION

System-compatible with Sortimo in-vehicle equipment and MIXX & CLICK.

The flexible **internal puller set in L-BOXX 1100-1.31/2** from GEDORE, with the 8 most popular used internal pullers and 2 counter supports, is ideal for both stationa-

ry and mobile applications. Bearings and bushes inside the housing can therefore be pulled out quickly and easily – and that with an internal diameter of up to 70 mm. Just one set is required for numerous individual uses, so no further investments are required. The Check-Tool insert fits into the L-BOXX and into workshop trolleys/workbenches with minimum dimensions of 400 x 310 x 90 mm. The sturdy L-BOXX design

ensures the universal set can also be used in tough and dirty work environments. With the practical plug-in connection, several L-BOXXes can also be plugged into each other and so transported.



Internal puller set in L-BOXX – 1100-1.31/2

1 SET OF THE 8 MOST COMMONLY USED INTERNAL PULLERS INCLUDING TWO COUNTER SUPPORTS

2 CHECK-TOOL INSERT FOR MOBILE AND STATIONARY USE

3 STURDY L-BOXX FOR SAFE STORAGE



**THE SET FOR
OUT AND ABOUT**

1100-1.31/2

INTERNAL
EXTRACTOR SET

in L-BOXX, 10 pieces

- > Universally usable set with the 8 most commonly used internal pullers and 2 counter supports for internal diameters up to 70 mm
- > With the L-BOXX® ideal for mobile and stationary use
- > Check-Tool insert for quick missing tool check
- > Check-Tool insert fits into the L-BOXX and tool trolleys/workbenches with minimum drawer dimensions 400 x 310 x 90 mm
- > L-BOXX® made of impact- and shock-resistant ABS plastic
- > Perfect for mobile use thanks to Easy Click System, as well as top and front handle
- > With tool card for increased flexibility and individual integration of further tools

€612,⁶¹
+ VAT

Code	No.	Contents	Length mm	Width mm	Height mm	Pieces	Weight kg
3461777	1100-1.31/2	1.30/2 Internal extractor for Ø 12-15 mm 1.30/3 Internal extractor for Ø 14-19 mm 1.30/4 Internal extractor for Ø 19-25 mm 1.30/4A Internal extractor for Ø 24-30 mm 1.30/5 Internal extractor for Ø 30-36 mm 1.30/6 Internal extractor for Ø 36-46 mm 1.30/7 Internal extractor for Ø 46-56 mm 1.30/8 Internal extractor for Ø 56-70 mm 1.36/1 Counter support for 1.30/0 - 1.30/5 1.36/2 Counter support for 1.30/6 - 1.30/7 EI-1100 CT-1.31/2 Check-Tool-Module, empty 1100 L GEDORE L-BOXX 136 with front handle	442	357	151	10	8,97

NEW

EXTERNAL-INTERNAL PULLER SET IN CHECK-TOOL INSERTS

The set always provides the right solution for a wide range of changing requirements and pulling work.

The practical and universal **external-internal puller set** for workshop trolleys and workbenches, **2005 CT4-1.04-1.40**, meets practically all requirements in the industrial, agriculture, automotive, commercial vehicle and trades sectors. The upgradeable set is also available for existing workshop trolleys, so changing customer requirements can be responded to at all times. The wide range of pullers in one set, for delicate to high-power work, guarantees the tools' efficient use for many, many years.



External-internal puller set for workshop trolleys and workbenches –
2005 CT4-1.04-1.40

1

EXTENSIVE PULLER SET FOR
WORKSHOP TROLLEYS AND
WORKBENCHES

2

FOR REMOVING FREE AND
TIGHT-SITTING COMPONENTS

3

ADJUSTABLE
CHECK-TOOL INSERT

4

FOR TAPER ROLLER BEARINGS, BALL
BEARINGS, INNER RINGS, BATTERY
TERMINALS AND FURTHER COMPONENTS



ALWAYS THE
RIGHT SOLUTION

2005 CT4-1.04-1.40

OUTSIDE-INSIDE PARTITION PULLER SET

for workshop trolleys & benches,
28 pieces

- > Practical set of universal external pullers, internal pullers and cutting blades for numerous areas of application
- > Wide range of pullers in one set – for delicate through to high-power use
- > Check-Tool insert can be flexibly adjusted to the required size
- > Safe and highly stressable, drop forged components
- > External puller with innovative high power components for twice the load capacity



€1057,⁹⁸ + VAT

Code	No.	Max. clamping depth mm	Max. Span mm	Length mm	Width mm	Height mm	Pieces	Weight kg
3461696	2005 CT4-1.04-1.40	330	165	633	390	60	28	10,63

Contents

136 K-105 Chain grip wrench 105cm for max.Ø 33cm
 1.04/HP1A-B Puller HIGH POWER 2-arm span width 130 mm x span depth 100 mm
 106/A-100-VB Extension 100 mm with brake
 1.1406200 Spindle M14x1,5 x 200 mm
 1.18/0XS Puller 2-arm XS hooks span width 50mm x span depth 70 mm
 1.18/0 Battery-terminal puller 2-arm span width 80mm x span depth 80 mm
 1.19/0XS Puller 3-arm XS Hook span width 50mm x span depth 70 mm
 1.19/0 Battery-terminal puller 3-arm span width 80mm x span depth 80 mm
 1.73/1 Universal ball joint puller for max. Ø 23mm max. span height 65mm Fork depth 24 mm
 1.30/1 Internal extractor for Ø 8-12 mm
 1.30/2 Internal extractor for Ø 12 - 15 mm
 1.30/3 Internal extractor for Ø 14 - 19 mm
 1.30/4 Internal extractor for Ø 19 - 25 mm
 1.30/4A Internal extractor for Ø 24 - 30 mm
 1.30/5 Internal extractor for Ø 30 - 36 mm
 1.35/1A Sliding hammer 700g for 1.30/0 - 1.30/5
 1.38/1 Separator puller span width 60-165 mm x span depth 230 mm
 1.38/AV Extension 100 mm (1 pair)
 1.40/1 Separator span width 12-75 mm
 EI-2005 CT4-1.04-1.40 Check-Tool-Module, empty

HIGHEST SAFETY WITH EVERY TYPE OF WORK

Ergonomic locksmith's hammer for conventional use on building sites and in workshops.

The **locksmith's hammer 600 E-300 ROTBAND-PLUS with ash handle** from GEDORE is 305 mm long and has a 300 g head weight. The sleeve, tapered collar, fixing plate and wood screw make the hammer head and wooden handle into one practically inseparable unit.

The top quality materials ensure a long service life – even with continuous daily use. The break-proof ash handle is from locally grown trees, and thanks to the steel handle sleeve it is permanently protected from damage with mishits.



Locksmith's hammer ROTBAND-PLUS with ash handle – 600 E-300

1 FORGED HAMMER HEAD (DIN 1041)

2 ROTBAND PLUS TECHNOLOGY FOR MAXIMUM WORK SAFETY

3 BREAK-PROOF ASH HANDLE IN ACC. WITH DIN 5111 B



600 E + H
ENGINEER'S HAMMER
ROTBAND-PLUS - THE ORIGINAL

- > Engineer's hammer with proven ROTBAND-Plus safety technology
- > ROTBAND-Plus handle protection sleeve
- > Hammer head hot drop forged, DIN 1041
- > Double-curved, long-lasting hickory or ash handle, DIN 5111



€14,45
+ VAT

from



Code	No.	Head weight g	Stick length mm	Length mm	Weight kg	excl. VAT
8581960	600 E-300	300	305	305	0,502	14,45
8582260	600 E-500	500	320	320	0,727	17,22
8583070	600 H-300	300	305	305	0,502	15,37
8583230	600 H-500	500	320	320	0,727	18,06

248 ST
RECOILLESS HAMMER

- > With very robust and durable steel tube handle
- > Splinter-proof, shatter-proof and wear-resistant polyamide heads, 75 Shore D, tested to -20° C

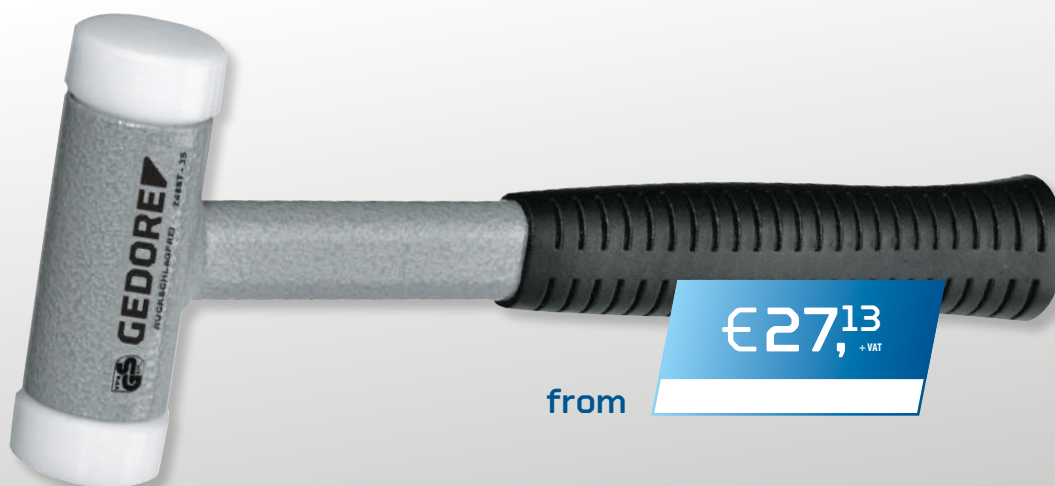

€27,13
+ VAT

from



Code	No.	Ø	Length mm	Weight kg	excl. VAT
8724070	248 ST-25	25	265	0,44	27,13
8828950	248 ST-30	30	290	0,6	28,06
8829090	248 ST-35	35	295	0,7	28,90
8829170	248 ST-40	40	300	0,8	31,67
8829410	248 ST-45	45	305	0,95	36,13
8829250	248 ST-50	50	310	1,005	38,90
8829330	248 ST-60	60	320	1,8	63,27

PRACTICAL SETS

119 L
PIN PUNCH SET
6 pieces

€36,¹³
+ VAT



> Striking heads inductively tempered

Code	No.	Contents
8866290	119 L	119-175-4 175-5 175-6 175-7 175-8 175-10

Pieces	Weight kg
6	0,58

106 D
TOOL SET
6 pieces

€25,²⁰
+ VAT



> Striking heads inductively tempered

Code	No.	Contents	Length mm	Width mm	Height mm	Pieces	Weight kg
8725710	106 D	97-125 150, 98-125, 99 12-3, 100-10, 119-4	175	112	26	6	0,805



104 SPLITTING CHISEL

flat



- > Carefully hardened and tempered along the full length
- > Striking heads inductively tempered
- > No. 104 HS with hand protection handle No. 108 UNI

from

€7,²²
+ VAT



Code	No.	Shank height mm	Blade width mm	Length mm	Weight kg	excl. VAT.
8723850	104	7	26,0	240	0,26	7,22
8723930	104 HS	7	26,0	220	0,4	13,61

95-200 FLAT COLD CHISEL

flat oval



- > Acc. to DIN 6453
- > Carefully hardened and tempered along the full length
- > Striking heads inductively tempered



Code	No.	Shank height mm	Blade width mm	Length mm	Weight kg
8698990	95-200	13	24,0	200	0,39

108 UNI PROTECTIVE HAND GUARD

€4,⁵³
+ VAT

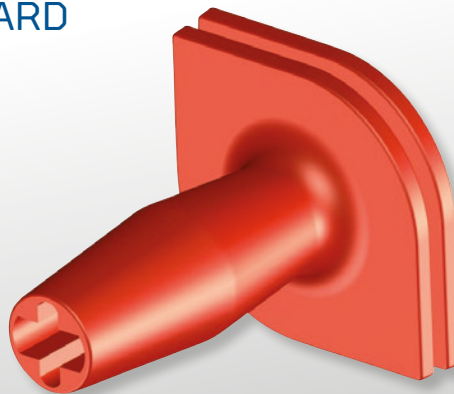

- > Highest safety for the hand in case of misses due to an enlarged and double protection plate
- > No rolling away (elliptical-shaped)
- > Jarring blows do not move into the hand
- > For all chisels from 250 mm length

Code	No.	for oval chisels	for 8-sided chisel	Weight kg
8658500	108 UNI	20 x 12	14	0,182
		23 x 13	16	
		26 x 13	18	
		26 x 7	20	

i NEW PLIERS DESIGN

Good-grip, hand-friendly and light!

The TC abbreviation stands for the new GEDORE pliers version with blue dipped plastic coatings in the handle area. The plastic handle on the pliers legs improves the grip, thus minimising the risk of slipping. The hands are also protected from temperatures that are too high or too low. The matt chrome-plated surface provides good protection against corrosion and thus affords the pliers a refined finish.

The combination of the matt chrome-plated forged parts and the plastic coating ensure a glare-free look.



NEW

8248-160 TC

ANGLED COMBINATION PLIERS



- › Chrome-plated design for improved rust protection
- › Induction-hardened precision cutting edges for longer service life
- › The angled head of the pliers allows fatigue-free working over a longer period of time
- › Dipped handles for comfortable handling and insulation at very high and low temperatures



Code	No.	Jaw length mm	Head width mm	Tip width mm	Head thickness mm	Cutting values	Weight kg
3463206	8248-160 TC	46	24,0	6,0	10,0	Soft wire: 4 mm / 6 AWG Medium hard wire: 3,1 mm / 8 AWG Hard wire: 2 mm / 12 AWG Cu cable, multi wire cross section: 16 mm ² Multi-wire cable Ø: 10 mm	0,22

8250-180 TC

POWER COMBINATION PLIERS



- › 35% less force required compared to conventional pliers
- › Chrome-plated design for improved rust protection
- › Induction hardened precision cutting edges for longer service life and improved cutting ability
- › Dipped handle covers for comfortable handling and insulation at high and low temperatures



Code	No.	Jaw length mm	Head width mm	Tip width mm	Head thickness mm	Cutting values	Weight kg
3462757	8250-180 TC	38	25,6	6,5	11,0	Soft wire: 5 mm / 4 AWG Medium hard wire: 3,4 mm / 8 AWG Hard wire: 2,5 mm / 10 AWG Piano wire: 2 mm / 12 AWG Cu cable, multi wire cross section: 16 mm ² Multi-wire cable Ø: 11 mm	0,227

NEW

8314-160 TC
SIDE CUTTER

Swedish pattern

€17,⁶¹
+ VAT



- > Chrome-plated design for improved rust protection
- > Slim head for optimum accessibility
- > Induction hardened precision cutting edges for longer service life and improved cutting ability



Code	No.	Length mm	Jaw width mm	Head thickness mm	Cutting values	Weight kg
3463605	8314-160 TC	160	22,0	10,0 mm	Soft wire: 4 mm / 6 AWG, Medium hard wire: 2,8 mm / 9 AWG Hard wire: 2 mm / 12 AWG	0,173

NEW

8132-160 TC
TELEPHONE PLIER

with cutting edge, serrated, straight pattern

€18,⁴⁵
+ VAT



- > Chrome-plated design for improved rust protection
- > Induction hardened precision cutting edges for longer service life and improved cutting ability
- > Flat and narrow jaw shape for firm and precise gripping as well as bending of cables or small workpieces
- > Precision cutting for separating material
- > Dipped handles for comfortable handling and insulation at very high and low temperatures



Code	No.	Length mm	Jaw length mm	Head width mm	Centre width mm	Head thickness mm	Thickness of point	Cutting values	Weight kg
3463087	8132-160 TC	160	50	16,5	3,2	9,0	2,5	Hard wire: 1,6 mm / 14 AWG Medium hard wire: 3 mm / 9 AWG	0,129

NEW

S 8303 TC
PLIER SET

3 pieces



- > Practical set of common pliers for everyday work
- > Chrome-plated design for improved rust protection
- > Induction hardened precision cutting edges for longer service life and improved cutting ability
- > Dipped handle covers for comfortable handling and insulation at high and low temperatures

€56,²⁶
+ VAT

Code	No.	Contents	Length mm	Width mm	Height mm	Pieces	Weight kg
3462781	S 8303 TC	Water pump pliers No. 142 10 TC, 10", 15-way adjustable, dip-insulated Power combination pliers No. 8250-180 TC, 180 mm, dip-insulated Power side cutter No. 8316-160 TC, 160 mm, dip-insulated	315	156	30	3	0,88

NEW

GOOD-GRIP PLIERS WITH NEW COATING

The water pump pliers is ideal for gripping, turning, loosening and tightening.

The water pump pliers 142 10 TC from GEDORE is ideal for numerous applications, such as stubborn screw connection or as an auxiliary handle on pipes for example – when it comes to gripping or turning tie rods or working on pipelines and pumps, the water pump pliers is always your reliable helper. The chrome-plated design for increased corrosion protection and the induction hardened serrated

faces ensure safe and efficient work results, with high stresses as well. Thanks to the handle covers dipped in plastic the pliers has a pleasant feel and, depending on where used, protects against high and low temperatures.

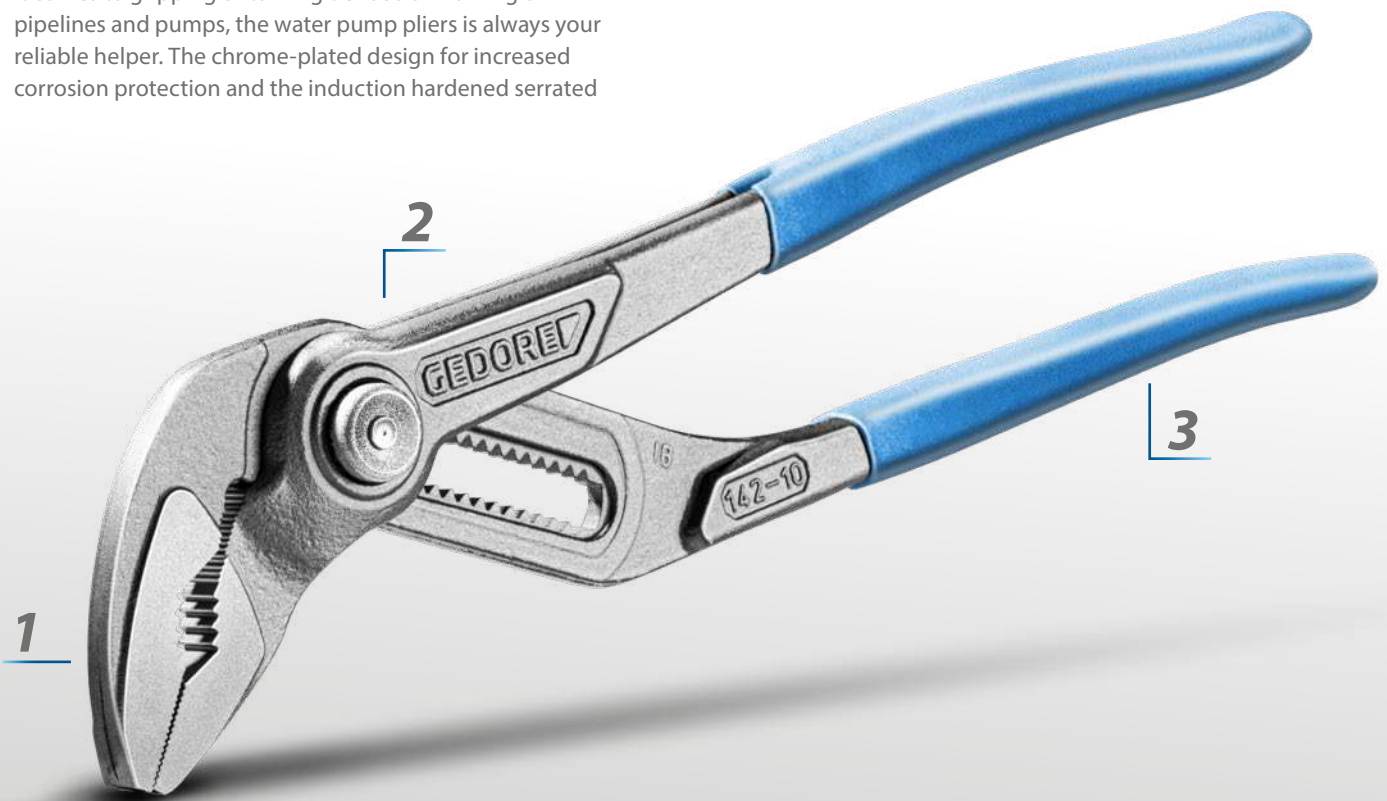

Water pump pliers – 142 10 TC

1 INCREASED DURABILITY OF THE SERRATED FACES WITH INDUCTION HARDENING

2 CHROME-PLATED DESIGN INCREASES DURABILITY

3 DIP-COATED HANDLE COVERS FOR ERGONOMIC WORKING

*DURABLE
PLIERS*

NEW

142 10 TC UNIVERSAL PLIERS

€28,⁵³
+ VAT



- › Chrome-plated design increases rust protection and durability of the pliers
- › Induction hardening increases the longevity of the teeth
- › Dipped handle covers for comfortable handling and insulation at high and low temperatures
- › Slightly curved handle shape as well as increased contact surface on the hand for ergonomic working
- › Size on the workpiece adjusted with push button fine adjustment
- › Clamping protection reduces risk of injury
- › Automatic clamping with opposing grip serrated faces

Code	No.	Length mm	Width mm	Height mm	Clamping reach mm	Weight kg
3462633	142 10 TC	250	7,5	48,0	38	0,345

142 16 TL UNIVERSAL PLIERS



€45,²⁰
+ VAT

- › Fine adjustment by push button
- › Push-button one-hand adjustment with large actuating surface
- › Offset gripping surfaces, self-clamping on nuts and tubes

Code	No.	Length mm	Clamping reach mm	Weight kg
3104486	142 16 TL	400	110	1,14

183 12 TC PLIER WRENCH

incl. protective jaws

€49,⁷⁴
+ VAT



- › Function of spanner and pliers in one tool
- › Gentle assembly of surface-sensitive screw connections (e.g. chrome-plated fittings)
- › Perfect for bending, holding, pressing and gripping different workpieces
- › Protective jaws optionally available

Code	No.	Size	Clamping reach mm	Length mm	Weight kg
3066045	183 12 TC	12	72	300	0,63

NEW

FIRM GRIP ON EVERYTHING

The light reinforcing steel pliers for every kind of wire.

The reinforcing steel pliers 8380 L from GEDORE are ideal for fixing steel rebar or twisting and cutting tying wire. The rounded handles make it easier to work without having to change your grip. The approximately circular head cross-section also makes the work easier. It then also enables problem-free twisting in tight and narrow areas. The high bending strength and stability in the rivet area make the pliers an especially sturdy and durable work assistant. An optimum lever ratio makes it

easy on the wrist, even with continuous stress, and reduces the physical effort when cutting wires. In addition to the dipped insulation version, the pliers are also available in a metal paint design.

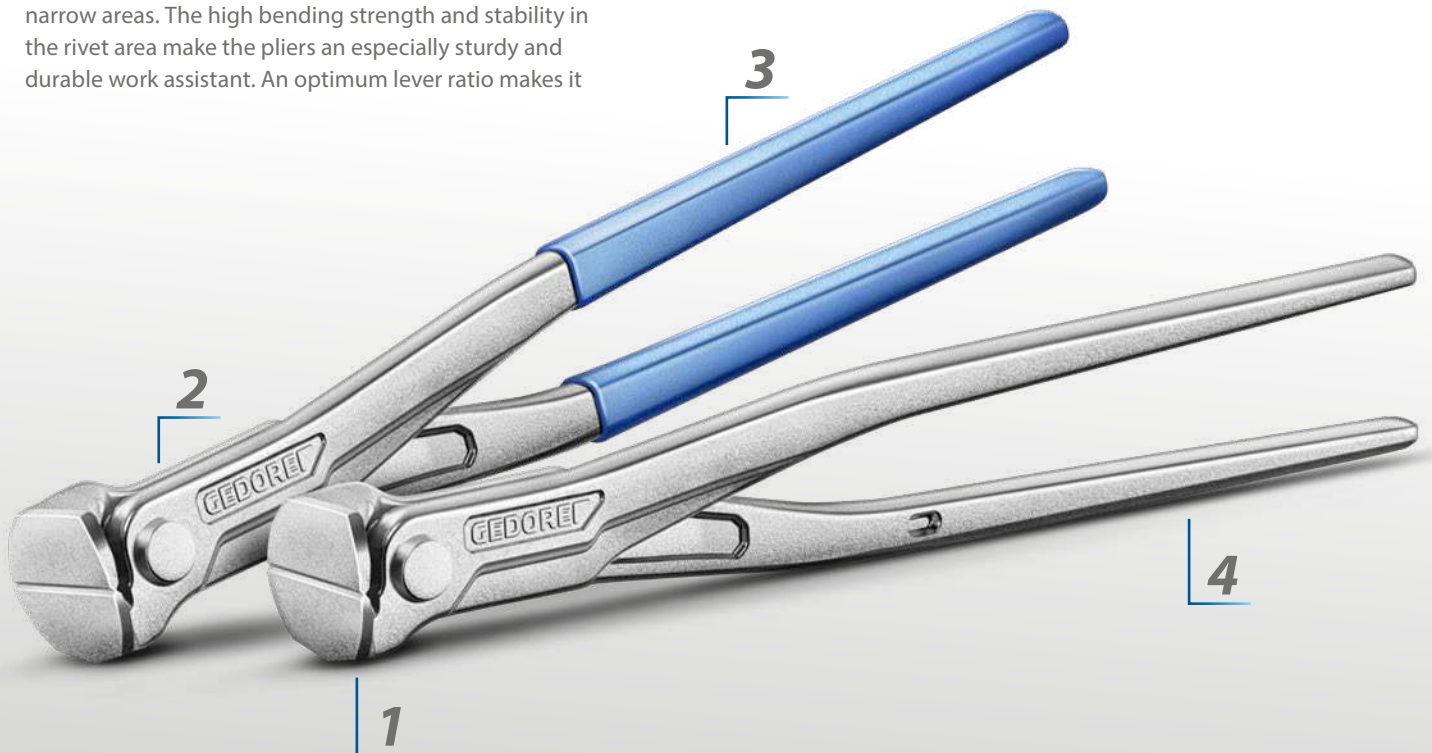

Reinforcing steel pliers – 8380 L

1 CIRCULAR HEAD CROSS-SECTION ENABLES EASY TWISTING

2 HIGH BENDING STRENGTH AND STABILITY WITH LOW WEIGHT

3 QUICK AND EASY WORKING WITH ROUNDED HANDLES

4 ERGONOMIC WORKING WITH OPTIMUM LEVER RATIO



8380
TOWER PINCER

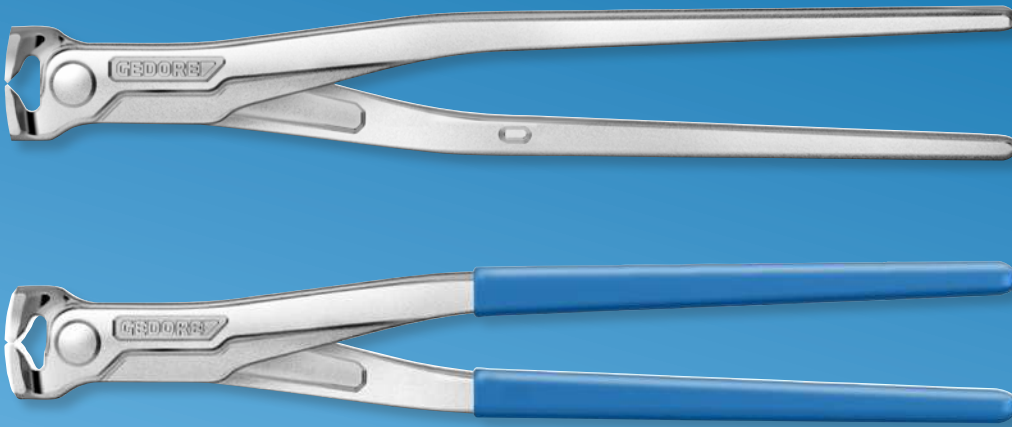

- > Rounded handles allow easy twisting by simply gripping around them
- > Easy twisting in tight places thanks to almost circular head cross-section
- > High bending stiffness and stability in the riveting area with low weight
- > Optimized leverage ratio for low effort when cutting wires
- > Available from June 1st, 2024

from

€14,¹⁶
+ VAT



Code	No.	Cutting values	Length mm	Weight kg	€ excl. VAT
3429075	8380-225 L	Hard wire: 1,6 mm / 14 AWG Medium hard wire: 2,4 mm / 11 AWG Soft wire: 3 mm / 9 AWG	225	0,315	14,16
6752020	8380-225 TL	Hard wire: 1,6 mm / 14 AWG Medium hard wire: 2,4 mm / 11 AWG Soft wire: 3 mm / 9 AWG	225	0,335	14,45
3429083	8380-250 L	Hard wire: 1,8 mm / 13 AWG Medium hard wire: 3,3 mm / 8 AWG Soft wire: 4 mm / 6 AWG	250	0,415	15,92
6752100	8380-250 TL	Hard wire: 1,8 mm / 13 AWG Medium hard wire: 3,3 mm / 8 AWG Soft wire: 4 mm / 6 AWG	250	0,435	16,29
3429091	8380-280 L	Hard wire: 2 mm / 12 AWG Medium hard wire: 3,8 mm / 7 AWG Soft wire: 5 mm / 4 AWG	280	0,455	18,06
6752290	8380-280 TL	Hard wire: 2 mm / 12 AWG Medium hard wire: 3,8 mm / 7 AWG Soft wire: 5 mm / 4 AWG	280	0,475	18,06

8320-200 JC
WIRE ROPE CUTTERS



€67,⁸¹
+ VAT

- > Easy-to-change cutting plates
- > Extremely soft shearing cut reliably prevents the wire rope from fanning out
- > Wire ropes up to 1800 N/mm² with max. 6 mm Ø (e.g. stainless steel wire ropes, wire ropes with steel and textile cables, Bowden cables, shrouds)
- > Wire up to 750 N/mm² with max. 4 mm Ø (e.g. nails/wire pins, screws, bolts, ceiling hangers)

Code	No.	Length mm	Weight kg
2788799	8320-200 JC	200	0,48

8150 CRIMPMAX-360 PROFESSIONAL CRIMPING PLIERS



€125,²¹
+ VAT

- > 360° crimping work area rotatable in 45° increments
- > For ferrules with and without insulating collar up to a length of 18 mm and a cross-section of 0.08 to 16.0 mm² and twin ferrules from 2x 0.25 to 2x 10.0 mm² in only one tool.
- > With automatic cross section adjustment
- > Unlockable ratchet for securing the complete crimping process



Code	No.	Capacity mm ²	AWG	Total length mm	Total width mm	Weight kg
3416437	8150	0,08-16	26-8	193	62	0,45

8151 CRIMPMAX-FLEX PROFESSIONAL CRIMPING PLIERS



€143,⁷⁰
+ VAT

- > Flexible tool system, consisting of basic tool and crimp die sets, which can be exchanged quickly and without the need tools
- > For crimping cables with conductor cross-sections up to 16 mm²
- > Ergonomic soft grips with slip guard
- > Positive lock secures the complete crimp



Code	No.	Applications	Capacity mm ²	AWG	Total length mm	Total width mm	Weight kg
3416445	8151	Wire end ferrules Insulated DIN cable lugs uninsulated cable lugs	0,14-10 0,5-6 0,1-10	26-8 20-10 26-8	220	80	0,51

8158 CRIMP WRENCH for conductor end-sleeves



€179,⁸³
+ VAT

- > Automatic cross-section adjustment from 0.08 to 16.0 mm² / AWG 28 - 5 without adjustment
- > Low manual force -30 % reduced compared to the tools known so far
- > Uniform hexagonal precision crimp over the entire length of the sleeve
- > Unlockable ratchet for securing the complete crimping process

Code	No.	Capacity mm ²	Total length mm	Weight kg
2956268	8158	0,08-16	250	0,5

8159

STRIPPMAX-ROUND PROFESSIONAL STRIPPING TOOL



- › For convenient stripping of all common round and moisture-proof cables with a diameter of 6.0 - 13.0 mm (e.g. NYM cable 3 x 1.5 mm² to 5 x 2.5 mm²)
- › Automatically regulated cutting depth, therefore also suitable for smaller cable diameters from 6 mm, e.g. 3 x 0.75 mm²
- › Length stop integrated in the housing for possible small series or for assembling cables with the same set-off dimensions
- › Durable quality. Robust, glass fibre reinforced polyamide, high quality knife steel from Solingen

€16,²⁹ + VAT

Code	No.	Capacity mm ²	Total length mm	Weight kg
3416461	8159	6-13	140	0,048

8154

STRIPPMAX-PISTOL PROFESSIONAL WIRE STRIPPER



- › Self-adjusting cutting and stripping tool for cross-sections from 0.02 - 10 mm²/ AWG 34 - 8. cassette with straight blade
- › Durable integrated cutting function
- › Cutting capacity: Flexible conductors, 10 mm²/8 AWG. Rigid conductors, 1.5 mm²/16 AWG
- › Fine adjustment option for removing thin and thick insulation without damaging the conductors

€76,⁸⁰ + VAT



Code	No.	Cable cross-section mm ²	AWG	Weight kg
3416453	8154	0,02 - 10	34-8	0,165

137

GRIP PLIERS



- › Forged, tempered jaws and special jaw shape for secure gripping, clamping and holding
- › Sophisticated jaw shape guarantees three-point support for any material cross section
- › No widening under most extreme loading
- › Safe release

€18,⁰⁶ + VAT

from

Code	No.	Total length mm	Weight kg	€ excl. VAT
6406620	137 7	185	0,288	18,06
6406700	137 10	230	0,526	23,52
6406890	137 12	300	1,042	45,20

S 8000 AE SET OF EXTERNAL CIRCLIP PLIERS

4 pieces



- › For retaining rings according to DIN 471, DIN 983
- › For retaining rings of 10-60 mm diameter (3/8"-2.3/8")
- › Inside-positioned opening spring
- › With inserted tips

€54,¹⁹_{+ VAT}



Code	No.	Contents
3041980	S 8000 AE	8000 AE 1 Circlip pliers, 8000 AE 11 Circlip pliers 8000 AE 2 Circlip pliers, 8000 AE 21 Circlip pliers

Pieces	Weight kg
4	0,63

S 8000 JE SET OF INTERNAL CIRCLIP PLIERS

4 pieces



- › For internal retaining rings
- › Indented tips made of highly wear-resistant rolling bearing steel
- › Anti-twist tip geometry
- › With straight and 90° angled tips

€63,²⁷_{+ VAT}



Code	No.	Contents
3041999	S 8000 JE	8000 JE 1 Circlip pliers, 8000 JE 11 Circlip pliers 8000 JE 2 Circlip pliers, 8000 JE 21 Circlip pliers

Pieces	Weight kg
4	0,58

VDE 2170-2160 PH-077 VDE SCREWDRIVER SET

7 pieces



- › Type of drive and size marked at end of the handle
- › Protective insulation up to 1000V AC according to DIN EN/IEC 60900, fully insulated blade
- › Ergonomic handle shape for precise, fatigue-free work
- › Positive-fit joint of handle and blade for optimum transmission of force

€49,⁷⁴_{+ VAT}



Code	No.	Contents
1616048	VDE 2170-2160 PH-077	VDE 2170 2,5 4 5,5 6,5 mm, VDE 2160 PH 0 1 2

Pieces	Weight kg
7	0,575

VDE 2162-2172 PM-06

VDE SCREWDRIVER SET SLIM DRIVE

6 pieces



- > For slotted, cross-recess PH and plus-minus screws
- > Ultra-small blade diameter yet with full mechanical and electrical safety
- > Insulated up to 1000 V, according to EN 60900/IEC 60900, fully insulated blade
- > Ergonomic 3-component handle Power-Grip³ for maximum power transmission with minimum stress on the hand

€45,²⁰
+ VAT

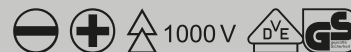

Code	No.	Contents
2928701	VDE 2162-2172 PM-06	VDE 2172 3.5 4 5.5, VDE 2162 PH1 2, VDE 2164 SL/PH2

Pieces	Weight kg
6	0,59

VDE 2162-2172 PZ-06

VDE SCREWDRIVER SET SLIM DRIVE

6 pieces



- > For slotted and cross-recess screws PZ
- > Ultra-small blade diameter yet with full mechanical and electrical safety
- > Insulated up to 1000 V, according to EN 60900/IEC 60900, fully insulated blade
- > Ergonomic 3-component handle Power-Grip³ for maximum power transmission with minimum stress on the hand

€43,³⁵
+ VAT

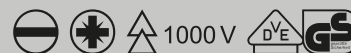

Code	No.	Contents
2928728	VDE 2162-2172 PZ-06	VDE 2172 3.5 4 5.5 6.5, VDE 2162 PZ1 2

Pieces	Weight kg
6	0,59

1101-003 VDE

VDE TOOL SET

in i-BOXX[®] 72, 8 pieces

€126,⁰⁵
+ VAT



- > VDE Basic set
- > Individually tested, VDE insulation up to 1000 V, acc. to EN 60900/IEC 60900, fully insulated blade



Code	No.	Contents	Width mm	Height mm	Depth mm
1828045	1101-003 VDE	VDE 8132-200 H, VDE 8250-180 H, VDE 8314-160 H VDE 2170 4 55, VDE 2160 PH 1 2, 4615 3	367	72	316

Pieces	Weight kg
8	2,3

VDE 1001
VDE TOOL SET
 12 pieces

€387,³⁹
 + VAT



- › With practical foam insert in sturdy PVC case
- › Protective insulation up to 1000 V



Code	No.	Contents	Width mm	Height mm	Depth mm	Pieces	Weight kg
6602560	VDE 1001	VDE 19 10 12 13 14 17 19 22 24 VDE 1993 U, VDE 1990-5 -10, VDE 1989 T, VDE 2170 5,5	395	106	295	12	3,1

KL-4600-200
**TOOL TROLLEY WITH HIGH-VOLTAGE
 ASSORTMENT**
 103 pieces



- › With its unique kit assembly, the high-voltage VDE tool trolley is ideal for working on hybrid and electric vehicles safely
- › Perfect for repair and maintenance work on vehicles of all manufacturers.
- › All tools are insulated with protection according to EN 60900/EC 60900
- › The tool trolley has side panels with Euro perforations, a heavy-duty chassis with external bearings, ball-bearing guide rails, and central locking

€3880,⁰⁰
 + VAT



Code	No.	Height mm	Width mm	Depth mm	Drawers	Static load carrying capacity kg	Load capacity kg	Number of drawers	Pieces	Weight kg
3415740	KL-4600-200	985	775	475	full extension	900	650	6	103	96

Contents

3/8" VDE Tool assortment with 6 - 22; XZN M8 - M12, 3/8" VDE Torque wrench 5 - 25 Nm, 1/2" VDE Tool assortment with 10 - 24; IN 5 - 8 mm VDE Open-end wrench 9 - 24, VDE Ring spanner 8 - 22, VDE Screwdriver slotted Phillips; TX T8 - T30, VDE Cable shears, VDE Universal pliers VDE Power combination pliers, VDE Power side cutters, VDE Needle nose pliers, angled, VDE Flat nose pliers, VDE Cable knife
 Meter connection fittings, Digital voltage tester 1.0000 V, Electrician protective gloves, Liner gloves, Rubber drape 250 x 350 mm
 ISO standing mat, Barrier tape, Warning sign „Lightning“, High-voltage warning sign „Switched on“, High-voltage warning sign „Switched off“
 Safety lock, Plastic clip 80 mm; 160mm, Cable spreader, Rubber mallet, Workshop trolley

1100-1094-95 ES
**VDE TOOL ASSORTMENT
 HYBRID + SUPPLEMENTARY SET**
 63 pieces



- Suitable for vehicles of all manufacturers
- All tools are insulated with protection according to EN 60900/EC 60900
- Equipped with a digital HV voltage tester and an empty compartment for VDE torque wrench 4508-02 / -05
- In its unique set composition, the VDE tool and supplement set, offers the possibility to ideally secure and work on hybrid and electric vehicles

€1529,00
 + VAT

Code	No.	Contents	Pieces	Weight kg
3445720	1100-1094-95 ES	3/8" VDE Socket No. VDE 30, SW 6 8 9 10 11 12 13 14 15 16 17 18 19 20 22 mm 3/8" VDE Screwdriver bit socket No. VDE INX 30, SW 8 10 12 mm 3/8" VDE Extension No. VDE 3090-3 -6, 75 150 mm 3/8" VDE Reversible ratchet No. VDE 3093 U, VDE Screwdriver slotted No. VDE 2170, 2,5 3,5 4 5,5 mm VDE Screwdriver philips No. VDE 2160 PH 1 2 3, VDE Screwdriver TX No. VDE 2163 TX T20 T25 T30, VDE Cable knife No. VDE 8094, 200 mm VDE Universal pliers No. VDE 146 10, 10", VDE Power combination pliers No. VDE 8250-200 H, 200 mm 2C-handle VDE Power side cutter No. VDE 8314-180 H, 180 mm, VDE Telephone plier No. VDE 8132 AB-200 JC, 200 mm angled 2C-handle VDE Flat nose pliers No. VDE 8120-160 H, 160 mm 2C-handle, VDE Cable knife No. VDE 4522, 180 mm Meter connection fittings No. V 914, Size 1 2 3, Digital voltage tester 1.000 V Electrician protective gloves, Liner gloves Rubber drape 250 x 350, ISO standing mat Barrier tape, Warning sign „Lightning“ High-voltage warning sign „Switched on“ High-voltage warning sign „Switched off“ Safety lock	63	18,5

1100-1094
**VDE TOOL ASSORTMENT
 HYBRID**
 53 pieces

€629,41
 + VAT



- The perfect range of tools for repair and maintenance work on hybrid and electric vehicles
- Suitable for vehicles of all manufacturers
- All tools insulated according to EN 60900/EC 60900
- GEDORE L-BOXX® 136 compatible with the Sortimo® in-vehicle equipment in your service mobile



Code	No.	Width mm	Height mm	Depth mm	Pieces	Weight kg
2979063	1100-1094	444	152	360	53	8,28
Contents 3/8" VDE Socket No. VDE 30, 6 8 9 10 11 12 13 14 15 16 17 18 19 20 22 mm, 3/8" VDE Screwdriver bit socket No. VDE INX 30, 8 10 12 mm 3/8" VDE Extension No. VDE 3090-3 -6, 75 150 mm, 3/8" VDE Reversible ratchet No. VDE 3093 U VDE Screwdriver slotted No. VDE 2170, 2,5 3,5 4 5,5 mm, VDE Screwdriver philips No. VDE 2160 PH 1 2 3, VDE Screwdriver TX No. VDE 2163 TX T20 T25 T30 VDE Cable cutter No. VDE 8094, 200 mm, VDE Universal pliers No. VDE 146 10, 10", VDE Power combination pliers No. VDE 8250-200 H, 200 mm 2-Component handle VDE Power side cutter No. VDE 8314-180 H, 180 mm VDE Flat nose pliers No. VDE 8132 AB-200 JC, 200 mm angled, 2-Component handle VDE Flat nose pliers No. VDE 8120-160 H, 160 mm 2-Component handle VDE cable knife No. VDE 4522, 180 mm, Counter sleeve No. V 914, size 1 2 3						

1100-1095 ES VDE SUPPLEMENTARY SET

in L-BOXX 136, 9 pieces



- > In its unique set composition, the VDE supplementary set offers the possibility to ideally secure and work on hybrid and electric vehicles
- > Perfect addition to the VDE tool assortment 1100-1094

€739,00
+ VAT

Code	No.	Contents	Width mm	Height mm	Depth mm	Pieces	Weight kg
3298655	1100-1095 ES	1x V 912 10 - Electrician protective gloves incl. liner gloves 1x VDE 910 25 - Rubber drape 250 x 350 1x V 911 100 - ISO standing mat, 1x Barrier tape 1x Warning sign „Lightning“, 1x Digital voltage tester 1.000 V 1x Safety lock, 1x High-voltage warning sign „Switched on“ 1x High-voltage warning sign „Switched off“	444	152	360	9	11

VDE 146 10 VDE UNIVERSAL PLIERS

7 settings

€49,74
+ VAT



- > With safety box joint and protection against blocking
- > Automatic clamping with offset gripping surfaces
- > Induction-rehardened serrated faces
- > Handles with VDE dipped insulation up to 1000 V, acc. to EN 60900/IEC 60900, two-ply Check-Tool insulation



Code	No.	Length mm	Clamping width mm	Weight kg
6120140	VDE 146 10	250	31	0,485

VDE 8092-160 H VDE CABLE SHEARS

€27,65
+ VAT



- > For cutting multi-core copper and aluminium cables up to max. 50 mm² or up to a Ø of 10 mm
- > Handles with VDE insulating sleeves up to 1000 V, acc. to EN 60900/IEC 60900
- > Precision grinding for optimum transmission
- > Hardness 55 HRC

Code	No.	Cable cross-section mm ²	Wire/cable diameter mm	Total length mm	Total length inch	Weight kg
3412407	VDE 8092-160 H	50	10	169	6 2/3"	0,21

VDE 8098-160 H
VDE STRIPPING PLIERS
 with insulating sleeves



- > V-shaped cutting jaws for stripping the plastic insulation of single- and multi-core conductors
- > Easy adjustment to the required wire or strand diameter by means of the set screw and lock nut
- > For wires from 0.5 to 10.0 mm²
- > Handles with VDE insulating sleeves up to 1000 V, acc. to EN 60900/IEC 60900



Code	No.	Length mm	Jaw length mm	Head width mm	Head thickness mm	Cable cross-section mm ²	Weight kg
1552074	VDE 8098-160 H	160	43,5	18,5	8,5	0,5-10	0,204

VDE 8131 AB-200 H
VDE MULTIPLE PLIERS
 with VDE insulating sleeves, angled pattern



- > Cable cutter, cables up to 5x2.5 mm² or Ø 12 mm
- > Stripping blades for wires 1.5 mm² and 2.5 mm²
- > Crimping profile: Crimping of ferrules
- > Handle insulated up to 1000 V, according to DIN EN IEC 60900



Code	No.	Total length mm	Weight kg
2910845	VDE 8131 AB-200 H	200	0,217

VDE 8250-180 H
VDE POWER COMBINATION PLIERS
 with insulating sleeves



- > Induction-hardened precision cutting edges, hardness 62 - 64 HRC
- > High cutting performance with guaranteed 35% less effort
- > Legs VDE insulated up to 1000 V, according to EN 60900/IEC 60900, 2-component handle protection sleeves



Code	No.	Jaw length mm	Head width mm	Tip width mm	Head thickness mm	Weight kg
1550950	VDE 8250-180 H	38,5	25,6	6,5	11,0	0,288

PRECISION UNDER HIGH VOLTAGE

Controlled screw tightening under voltage is now also required more and more often!

The **VDE torque wrench VDE 4508** from GEDORE is simply perfect for precise and controlled screw connection tightening under voltage. The proven release system from our Torcofix torque wrench range triggers a tactile and audible signal when the set torque value is reached. Via the vernier scale and depending on the model, the clear monoscale with Nm division enables a precise 0.10 / 0.25 Nm adjustment of the torque value. The VDE accessories, such as extensions or sockets, are secured against unintentional loosening with a locking button, which is also easy to use with safety gloves on.

The wrench comes with a test certificate in acc. with DIN EN ISO 6789-2:2017. The specified standard (+/- 4 %) is exceeded for your safety. The wrench is VDE-insulated up to 1,000 V, and meets the requirements in acc. with EN 60900/IEC60900.



VDE torque wrench – VDE 4508

1 TESTED QUALITY IN ACC. WITH
DIN EN ISO 6789-2:2017

2 PRECISE WORKING BY
EXCEEDING THE SPECIFIED
STANDARD OF +/- 4%

3 TACTILE AND AUDIBLE
TRIGGER SIGNAL

4 EASY OPERATION, EVEN
WITH SAFETY GLOVES ON
AS WELL





VDE 4508
VDE TORQUE WRENCH
 5-25 Nm - 10-50 Nm

- › Controlled screw tightening in the most common range' Release system generates a clear tactile and audible release signal
- › Scale with one Nm graduation
- › Classified according to DIN EN ISO 6789-2:2017 Type II Class A, incl. traceable test certificate, calibrated to a maximum permissible deviation of +/- 3 % and therefore more precise than the +/- 4 % required by the standard
- › Safety button to prevent unintentional loosening of the socket spanner insert
- › VDE insulated up to 1000 V, in accordance with EN 60900/IEC 60900



from

€343,⁷⁰
 + VAT



Code	No.	Type	Square drive inch	Square drive metric mm	Nonius	Height mm	Nm	Housing - square centre spacing mm	Length mm	Scale divisions	Head width mm	Head height mm	Weight kg	excl. VAT.
3125335	VDE 4508-02	Reversible ratchet	3/8"	10	1	75	5-25	24	319		50,0	62	0,714	343,70
3079066	VDE 4508-05	Reversible ratchet	1/2"	12,5	2,5	80	10-50	24	369		48,0	62	0,825	360,50

**WORK SAFELY AND
INNOVATIVELY**

AUTOMOTIVE SELECTION



gedore-automotive.com

KL-5501 B
**SPRING COMPRESSOR
STATIONARY**

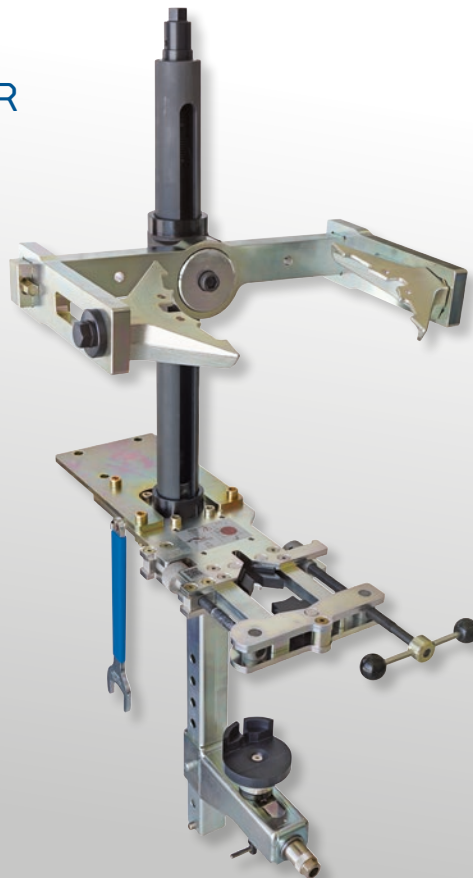

- > A quick, easy and effective tightening of almost any McPherson spring / damper leg available on the market, combined with maximum safety
- > As the spring is tensioned via the upper spring plate against the lower one, the shape of the spring or the spring pitch is irrelevant
- > The adapter plate allows the spring compressor to be easily mounted on a tool/assembly trolley or workbench
- > Maximum safety!

€2842,⁸⁶
+ VAT

Code	No.	Distance to work mm	Load max.	Drive connector hexagon mm	Weight kg
3230503	KL-5501 B	570	15.000	24	46

KL-0173-460 K RE-THREADING TOOL KIT

€950,00
+ VAT



- › This special infinitely variable rethreading tool enables fast and cost-saving reforming of damaged threads on wheel studs and wheel bolts, directly on the vehicle
- › In this process, the thread is formed back to its original geometry by rolling (forming, pressing, shaping), without cutting
- › As a result, the strength of the thread is fully retained, and, in addition, the surface is compacted again
- › Unlike thread cutting or filing, no material is removed and the thread maintains the dynamic load capacity which is up to 2 times higher, even after the repair

Code	No.	for thread	Thread type	Pitch	Pieces	Weight kg
3436217	KL-0173-460 K	M50 - M110	Right/left-hand thread	1,5	9	3

KL-0173-460X THREAD ROLLING SET

€140,00
+ VAT



- › By using the thread rolling set, the re-threading tool KL-0173-460 K is also suitable for right-hand thread with 2 mm pitch

Code	No.	Pitch	Number of rollers	Pieces	Weight kg	excl. VAT.
3436098	KL-0173-4601	1,0	3	3	0,35	140,00
3436160	KL-0173-4604	2,0	3	3	0,35	140,00

KL-0173-612 A RE-THREADING TOOL FOR WHEEL STUDS

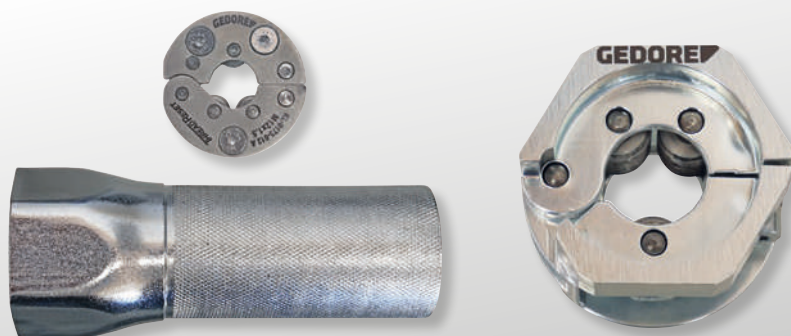

€95,00
+ VAT

- › Universal use for cars and vans, thread size covers approx. 80% of approved vehicles with wheel studs
- › Fast, chipless and cost-saving recovery of damaged threads on wheel studs and wheel bolts without material removal
- › As a result, the strength of the wheel studs or wheel bolts is fully retained
- › Compact design, drive with conventional hexagonal socket with reversible ratchet

Code	No.	for thread	Drive connector hexagon	Weight kg
3461874	KL-0173-612 A	M12x1,5	41 mm	0,24



VIDEOSCOPE FOR VISUAL ANALYSIS

Make hard to reach points visually accessible.

Damage analysis in engine compartments, narrow shafts or other hard to access work areas is frequently made more difficult by a restricted field of vision. The **Videoscope KL-0880-10 K** from GEDORE is just the ticket with a range of 1 metre – no cables required thanks to the battery. Along with live viewing, the extremely small micro camera with 3.9 mm diameter

also enables photo and video documentation with date and time stamp. Dark areas are made visible with the 6 adjustable LED lights. The dust and water-protected lens ensures professional visual analysis at all times. The 2-way joint enables 360° viewing in the most confined installation spaces and reduces dismantling work with bad accessibility to a minimum. The live pictures and recordings are shown on a high-resolution HD colour display. Alternatively you can also connect a smartphone or tablet to the device.



Videoscope Ø 3.9 mm – KL-0880-10 K

1

PHOTOS AND VIDEOS SHOWN DIRECTLY ON THE DISPLAY

2

QUICK AND EASY INSPECTION WITH THE EXTREMELY THIN MICRO CAMERA

3

DUST AND WATER-PROTECTED LENS FOR PROFESSIONAL DAMAGE ANALYSIS

4

FLEXIBLE USE WITH 180°, 2-WAY JOINT AND 1 M CABLE LENGTH

KEEP A CLEAR OVERVIEW

KL-0880-10 K VIDEOSCOPE

8 pieces



€699,⁰⁰
+ VAT

- > Extremely slim micro camera with Ø 3.9 mm
- > Dust- and water-proof lens with adjustable LED illumination
- > ±180° 2-way articulation enables photo, video, live viewing to front and rear
- > Professional photo and video documentation with date and time stamp
- > Connection with smartphone, tablet and laptop etc. possible

Code	No.	Display size	Screen resolution	Total swivel angle	Number of lamps	Battery capacity	Storage	Width mm	Height mm	Depth mm	Weight kg
3444910	KL-0880-10 K	5,0"	1280x720	+/- 180°	6	5.000 mAh	Hard shell bag	350	70	260	1,2

KL-0169-6X TRACK ALIGNMENT GAUGE

€123,⁶⁰
+ VAT

from



- > To extend the measuring range of the toe measuring gauge KL-0169-60 from 1500 mm to a maximum of 2150 mm
- > Measuring range easily adjustable via telescopic extension from 950 to max. 1500 mm (extendable to max. 2150 mm)
- > Easily legible toe difference scale from 0 to 40 mm

Code	No.	Measuring range (min.) mm	Measuring range (max.) mm	Scale length	Length mm	Weight kg	excl. VAT.
3230295	KL-0169-60	950	1500	40	1.500	2,1	249,90
3230317	KL-0169-61	1600	2150		670	0,45	123,60

KL-0169-8X TIE ROD SPANNER

from

€76,³¹
+ VAT



- > For quick and professional loosening and adjusting of sluggish tie rods.
- > The special split design of the tie rod spanner completely encloses the mating surfaces on the adjusting thread of the tie rod
- > Conventional open-end spanners are usually too wide or expand under the high force required



Code	No.	Width across flats mm	Drive connector square inch	Weight kg	excl. VAT.
3245810	KL-0169-81	34	3/4"	1,1	102,50
3468097	KL-0169-8330	30	3/4"	0,4	76,31

KL-0169-82
TIE ROD END SOCKET
WRENCH

€117,⁵⁰
+ VAT

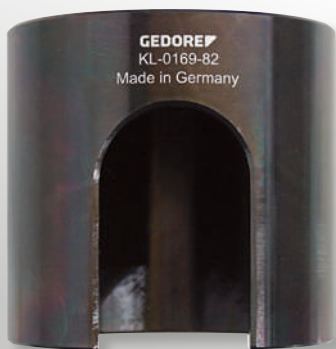

- > For quick and professional installation and removal of sluggish tie rod ends
- > The release tool grips the entire tie rod end
- > This allows a high force to be applied for loosening with the help of a 3/4" ratchet

3/4"

Code	No.	Drive connector square inch	Inside Ø mm	Outer Ø mm	Weight kg
3267806	KL-0169-82	3/4"	80	95	1,9

KL-4007-411
3/4" SWIVEL HANDLE

€119,³²
+ VAT



- > Extra long version (980 mm) with 180° joint
- > Suitable for extremely tight screws

3/4"

Code	No.	Drive connector square	Total swivel angle	Load (max.) Nm	Length mm	Weight kg
2941554	KL-4007-411	3/4"	180°	1.050	980	3,5

KL-4007-500
UNIVERSAL SPANNER
EXTENSION

€52,⁰⁰
+ VAT



- > For easy extension of open-end spanners, combination spanners, offset combination spanners, and angled pin spanners
- > Required, for example, when loosening stuck screw connections in places which are difficult to access

Code	No.	Length mm	Weight kg
3406504	KL-4007-500	380	0,65

KL-0121-512
HOSE CLAMP PLIERS



- > For removing and installing fuel, oil, cooling and hot water hoses, which are secured by space-saving, reusable and self-tightening spring band clamps
- > Due to the special design of the pliers, the clamps can be gripped straight or offset by 90°

€49,⁰⁰
+ VAT

Code	No.	Length mm	Weight kg
3435504	KL-0121-512	205	0,3

245610
**MANUAL BENDING
 TOOL SET**
 hydraulic, 9 pieces

€676,⁴⁷
 + VAT

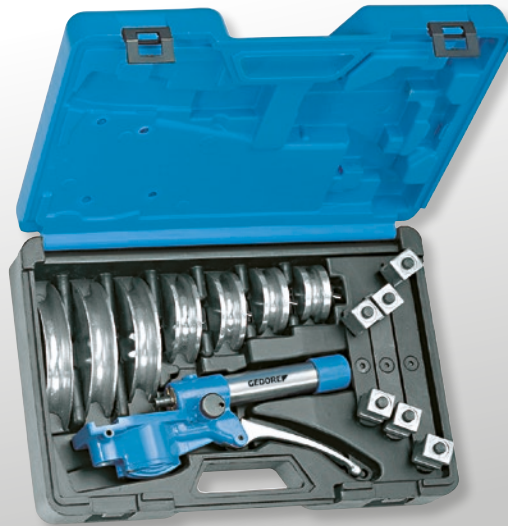

- > For soft copper pipes EN 1057 up to 22 mm (also heat-insulated), composite pipes up to 20 mm as well as precision steel pipes EN 10305-3 (DIN 2394) up to 18 x 1.5 mm
- > With 7 bending formers for pipes with Ø 10, 12, 14, 15, 18, 20 and 22 mm and corresponding counter-supports
- > Hydraulic drive without great effort

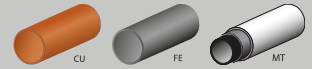

Code	No.	Contents	Pieces	Weight kg
4635230	245610	1 Base unit, hydraulic No. 245670 7 Bending tools for pipes with Ø 10, 12, 14, 15, 18, 20, 22 mm 1 plastic case No. 245590	9	5,87

280100
**ECCENTRIC
 ANGLE BENDER**

€1173,¹¹
 + VAT

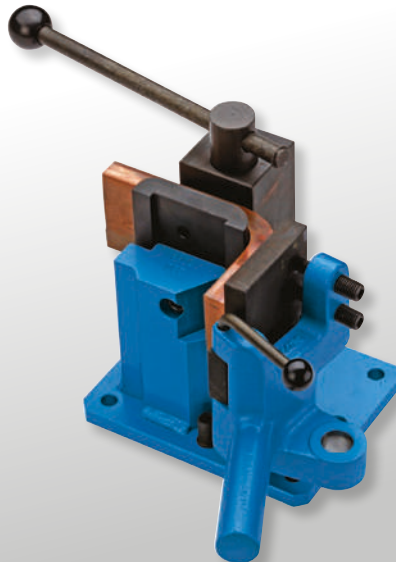

- > For round, flat and angle material made of steel, copper and aluminium up to 90°
- > With infinitely adjustable angular stop
- > With length stop
- > Manual basic unit for mounting on the workbench, with optional base frame No. 268500 also suitable for stationary use

Code	No.	Weight kg
4535010	280100	32,5

1100-278601
**MANUAL BENDING
 TOOL SET
 IN L-BOXX® 136**
 in L-BOXX® 136, 12 pieces

€558,⁸²
 + VAT



- > Precision steel pipes EN 10305-3 (DIN 2394)
- > Hydraulic pipes EN 10305-1 (DIN 2391) with 1.0 - 2.0 mm wall thicknesses
- > Composite pipes up to 16 mm
- > Bendable stainless steel tubes with wall thicknesses from 1.0 - 1.5 mm

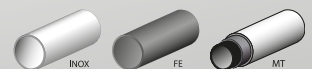

Code	No.	Contents	Width mm	Height mm	Depth mm	Weight kg
1611526	1100-278601	1 Basic frame 6-18 mm No. 278670, 1 Bending lever 6-18 mm attachable No. 278680 8 Aluminium bending formers for pipes with Ø 6, 8, 10, 12, 14, 15, 16, 18 mm 1 Pipe cutter 3-35 mm Ø No. 2180 3, 1 Pin punch 3 mm + GEDORE L-BOXX® 136 No. 1100 L	444	152	360	8,28



THE BEST
STEEL WITH
THE BEST
CUT

FIND OUT

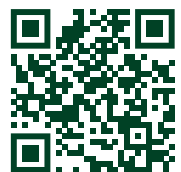



OCHSENKOPF

BY GEDORE



Germany's oldest axe forge **OCHSENKOPF** stands for perfection and safety in forestry and carpentry tools. Since its foundation in 1781, the Remscheid axe forge has been forging the best steel with the best grind to the highest quality level.

An OCHSENKOPF axe stands for craftsmanship at the highest level and is still the pride of the traditional Bergisch tool industry today.

ochsenkopf.com

STURDY UNIVERSAL FOREST AXE

The **OCHSENKOPF** forest axe is ideal for all kinds of forest and garden work.

The **universal forest axe ROTBAND-PLUS OX 620 H-1257** is the flexible use axe for every kind of wood – for felling, delimiting and splitting. The break-proof hickory wood handle and the cutting edge's crowned grinding ensure low maintenance cost.

The cow's foot shape handle provides firm gripping and prevents the axe from slipping out of the hands. The **ROTBAND-PLUS** technology also ensures a long service life and therefore greater safety as well. The long handle sleeve protects it from damage if the hammer mishits.



Universal forest axe ROTBAND-PLUS – OX 620 H-1257

1 VERSATILE USE FOR ALL KINDS OF WOOD

2 ROTBAND-PLUS FOR MAXIMUM WORK SAFETY

3 COW'S FOOT SHAPE FOR FIRM GRIP

4 LONG HANDLE SERVICE LIFE WITH HANDLE SLEEVE



SOLID AND
STURDY
WORKMANSHIP



OX 620 H-1257
UNIVERSAL FORESTRY AXE
ROTBAND-PLUS

Rhineland pattern

- > Indispensable for forest and garden work
- > With ROTBAND-PLUS handle attachment: handle protection sleeve, ring wedge, safety plate and wood screw make the handle and head one unit and ensure maximum work safety
- > In addition, the long steel handle protection sleeve protects the handle in the event of mis-hits and guarantees a long service life
- > With high-quality hickory handle in cow foot shape



Code	No.	Test seal (OCH)	Weight of head g	Blade width mm	Handle length	Weight kg
1879812	OX 620 H-1257	KWF STD, GS	1250	120,0	700	2,1

OX 648 H-2508
SPALT-FIX®-AXT ROTBAND-PLUS

- > Optimum splitting results, less force required due to wedge-shaped blade
- > With patented handle join ROTBAND-PLUS: Handle sleeve, tapered collar, fixing plate and wood screw bond the hammer head and the handle into one unit and ensure an optimum in safety
- > The long handle sleeve made of steel protects the handle from damage when the hammer misses its target. This guarantees a long service life
- > With high-quality hickory wood handle in knob form



Code	No.	Test seal (OCH)	Weight of head g	Blade width mm	Handle length	Weight kg
1852701	OX 648 H-2508	KWF STD, GS	2500	115,0	800	3,55

STURDY SPLITTING HAMMER

Top quality professional splitting hammer from Ochsenkopf for splitting medium and large logs and for driving in aluminium and plastic wedges.

Totally reliable: The **BIG OX ROTBAND-PLUS OX 635 H-3009** wood splitting hammer from OCHSENKOPF with break-proof hickory wood handle and steel head. The cutting edge's crowned grinding ensures high edge retention and low maintenance cost. A vibration-redu-

cing function provides greater safety with handle breakage and increased working comfort. The ROTBAND-PLUS technology also ensures a long service life and therefore greater safety as well. The long handle sleeve protects it from damage if the hammer mishits.



Wood splitting hammer BIG OX ROTBAND-PLUS – OX 635 H-3009

1

HIGH EDGE RETENTION WITH CROWNED GRINDING

2

ROTBAND-PLUS FOR MAXIMUM WORK SAFETY

3

MORE COMFORT WITH BREAK-PROOF HICKORY WOOD

4

LONG HANDLE SERVICE LIFE WITH HANDLE SLEEVE



SAFE SPLITTING



OX 635 H-3009
WOOD SPLITTING HAMMER
PROFESSIONAL BIG OX®

- › With ROTBAND-PLUS handle attachment: handle protection sleeve, ring wedge, safety plate and wood screw make the handle and head a single unit and ensure maximum work safety
- › In addition, the long steel handle protection sleeve protects the handle in the event of a miss and guarantees a long service life
- › Forged hammer head with reversible nose and extra large striking surface, e.g. for driving wedges
- › With high-quality handle in pommel shape made of hickory wood and cutting edge protection



€90,67
 + VAT



Code	No.	Test seal (OCH)	Weight of head g	Blade width mm	Handle length	Weight kg
1707663	OX 635 H-3009	KWF PRO, GS	3000	70,0	900	4,2

OX 173 E-0500
HAND HOOKEROON

- › For moving and picking up small tree trunks and moving lumber
- › For ergonomic working, kind to the back
- › With high-quality handle in cow's foot shape made of ash wood

€37,05
 + VAT



Code	No.	Test seal (OCH)	Handle length	Weight kg
1592408	OX 173 E-0500	KWF PRO	380	0,775



TOOLS FOR LIFE

GEDORE Werkzeugfabrik GmbH & Co. KG

Remscheider Straße 149
42899 Remscheid · GERMANY
Tel. + 49 (0) 21 91- 596 - 0
Fax + 49 (0) 21 91- 596 - 230
info@gedore.com
www.gedore.com

Vertrieb Deutschland
Tel. + 49 (0) 21 91- 596 - 900
Fax + 49 (0) 21 91- 596 - 999

GEDORE Automotive GmbH

Breslauer Straße 41
78166 Donaueschingen · GERMANY
Tel. +49 771 83223-0
Fax +49 771 83223-90
info.gam@gedore.com
www.gedore-automotive.com

GEDORE Torque Solutions GmbH

Bertha-Benz-Straße 12
71665 Vaihingen/Enz · GERMANY
T +49 7042 9441-0
F +49 7042 9441-41
torque-solutions@gedore.com

GEDORE AUSTRIA GmbH

Gedore-Str. 1
8190 Birkfeld / Stmk. · AUSTRIA
Tel. +43 (0) 3174 / 363 64 00
Fax +43 (0) 3174 / 363 83 20
sales.austria@gedore.com
www.gedore.at

GEDORE Tools S.A. (Pty) Ltd.

103 Qashana Khuzwayo (Shepstone) Road,
New Germany, 3610 - South Africa
PO Box 68, New Germany, 3620
SOUTH AFRICA
Tel. +27 (0) 31 / 705 3587
Fax +27 (0) 31 / 705 32770
esales@gedore.co.za
www.gedore.co.za

GEDORE IBÉRICA S.L.

c/Arangutxi 12, Poligono Industrial de Júndiz
01015 Vitoria Alava · SPAIN
Tel. +34-945-29 22 62
Fax +34-945-29 21 99
gedore@gedore.es
www.gedore.es

GEDORE Torque Ltd

(Formerly Gedore UK)
Tannery Lane, Gosden Common
Bramley, Guildford
Surrey
GU5 0AJ · UNITED KINGDOM
Tel. +44 (0) 1756 / 70 67 00
sales@gedoreuk.com
www.gedoreuk.com

GEDORE France SARL

Parc d'activités des Béthunes - La Mare II
10, avenue du Fief - Bât. 12
BP 79144 Saint-Ouen-l'Aumône
F-95074 Cergy Pontoise Cedex · FRANCE
Tél. +33 (0)1 34 40 16 60
Fax +33 (0)1 34 40 16 61
jadore@gedore.fr
www.gedore.fr

GEDORE TECHNAG B.V.

Flemingweg 7, 2408 AV
Alphen aan den Rijn · NETHERLANDS
Tel. +31 (0) 172 / 42 73 50
Fax +31 (0) 172 / 42 73 60
info@gedore.nl
www.gedore.nl

GEDORE (INDIA) Private Limited

148, Sector 3, IMT Manesar
Gurgaon – 122051
Haryana · INDIA
Tel. +91 (0) 124 22910 – 65/66/67
Fax +91 124 2341067
sales@gedoreindia.com
www.gedore.in

GEDORE POLSKA Sp. z o.o.

ul. Żwirki i Wigury 56a
43-190 Mikołów · POLAND
Tel. +48 (0) 32 / 738-40 10
Fax +48 (0) 32 / 738-40 20
gedore@gedore.pl
www.gedore.pl

Ferramentas GEDORE do Brasil S.A.

Rua Vicentina Maria Fidélis,
275 Bairro Vicentina
São Leopoldo - RS | 93025-340 · BRAZIL
Tel. +55 51- 3589 9200
Fax + 55 51- 3589 9222
export@gedore.com.br
www.gedore.com.br

GEDORE TOOLS INC

4055 Faber Pl Dr
North Charleston SC, 29405 · USA
Phone: +1 (843) 225 5015
Fax: +1 (843) 300 0315
info@gedoretools.com
www.gedoretools.com

GEDORE Tool Trading (Shanghai) Co., Ltd.

1/F, Block 2, 1358 Pingan Road,
Minhang, Shanghai · CHINA 201109
Tel. +86-21-3388 7258
Fax +86-21-3388 7259
Service Hotline: 400 880 1858
info@gedore.cn
www.gedore.cn

Your dealer:

Brands of the GEDORE Group
gedore.com · ochsenkopf.com

MAGIC 2024 TOOL PROMOTION valid
from 01/03/2024 until 31/12/2024.
While stocks last.

*Special net prices per pc./set, plus VAT. Delivery without decoration.
Technical specifications subject to modifications. No liability for printing errors.
Prices exclude VAT / for resellers only. Please ask your local dealer.

gedore.com